



LINEAR MICROSTRIP ANTENNA ARRAY FOR 5G COMMUNICATION APPLICATIONS

Tharun Tej D¹, Dr. Shivapanchakshari T G², Virupaksha G R³, Shivakeerthi B T⁴ and Suhas S B⁵

²Professor & Head of the department, Department of Electronics and Communication Engineering, Cambridge Institute of Technology (CI Tech), Bengaluru, India

^{1,3,4,5}Student, Department of Electronics and Communication Engineering, CITech, Bengaluru, India

Abstract: In the world of wireless communication, there is an increasing demand for high-performance MIMO (Multiple Input Multiple Output) antenna systems tailored for smartphone applications. MIMO technology increases data rates, coverage, and reliability by using multiple antennas for transmission and reception. However, integrating MIMO antennas within the constraints of compact smartphone designs is fraught with difficulties, particularly in terms of guaranteeing adequate isolation between antenna parts to minimize interference. This work investigates the design and implementation of a MIMO antenna system specifically designed for smartphone applications in order to establish and maintain excellent isolation between antenna sections. Many design strategies are investigated, including better materials, decoupling techniques, and antenna element placement. In addition, recent advances in the fields of metamaterials, smartphone form factor integration, and micro antenna designs are discussed. Furthermore, the study addresses performance metrics including data throughput, power economy, and dependability, providing an understanding of the practical uses of these advancements. This paper's main objective is to promote MIMO antenna systems for smartphones by offering a comprehensive grasp of the challenges, solutions, and most recent developments in achieving high isolation within small form factors.

Keywords: Smartphone applications, High isolation.

INTRODUCTION`

The proliferation of smartphones has increased the need for reliable and fast wireless in the rapidly growing communication field MIMO (Multiple Input Multiple Output) antennas, which combine the capabilities of multiple antennas for transmission and the reception, is necessary to meet this requirement There is a significant barrier to integration, especially when adequate isolation between antenna segments is required Proper isolation between antennas can provide the signal quality has deteriorated, potentially threatening the reliability and efficiency of smartphone communication systems.

In recent years, there has been a greater effort to address the difficulty of attaining high isolation in MIMO antenna systems for smartphones. Engineers and researchers have worked to create novel approaches that maximize antenna performance in portable electronics with limited space. These endeavours encompass an array of methodologies, such as refined antenna configurations, novel materials, and advanced signal processing techniques, which significantly augment isolation and mitigate interference. Aiming for this enhancement could lead to unprecedented performance from smartphone antennas.

In the past several years, there has been a significant increase in research and development efforts aimed at enhancing MIMO antenna systems for smartphone applications. New materials, design techniques, and signal processing methods that are especially suited to enhancing the effectiveness and performance of MIMO antennas in smartphones have evolved as a result of these efforts. By analysing these advancements, this paper seeks to provide a comprehensive overview of the state-of-the-art in MIMO antenna design. In smartphone scenarios, achieving high isolation is especially important to minimize interference and

maximize signal integrity. The purpose of this study is to present the most recent advancements in remote MIMO antenna systems specifically created for use with smartphones. By means of thorough investigation and recent advancements in antenna designs, integration methods, and methodologies by looking at their exclusion. We also discuss the advantages of these developments and elucidate how they might improve the overall dependability, capacity efficiency, and data speeds of smartphone networks. Our goal is to significantly advance the hunt for high-performance wireless communications in handheld devices by bridging the gap between theory and experience.

Literature Review:

Four studies that concentrate on the design and improvement of multiple input multiple output (MIMO) antenna systems for diverse wireless communication applications are included in the literature study [1]. A portable dual-band MIMO antenna system for 5G smartphone applications is presented by Yuan et al. in 2020 [2]. The antenna's novel design techniques allow it to accommodate various frequency bands—which are crucial for 5G technology—and achieve excellent object separation [3]. The study considerably advances antenna technology for the upcoming generation of wireless communication systems and will be presented at the IEEE MTT-S International Microwave Workshop Series in 2020[4]. Oiconomopoulos-Zachos et al. (2017) present MIMO antenna arrays for Wi-Fi base stations utilizing waveguide technology in a different study [5]. These algorithms improve wireless communication, boost signal strength and coverage for dependable wireless access, and offer insightful information for imaginative Wi-Fi network design [6]. Together, these research help MIMO antenna technology advance and solve a number of issues, including size reduction, isolation enhancements, and possible prospects for SAR compliance in the design of next-generation smartphone base stations.

Methodology:

1. Design of Ground Plane:

Establish the dimensions and form of the ground plane based on the antenna specifications and the expected performance.

Ground plane design guarantees proper antenna grounding and minimizes interference.

2. Substrate Selection:

FR-4, Rogers, and other suitable substrate materials can be chosen depending on the intended antenna properties, frequency range, and surrounding conditions.

Antenna performance is affected by substrate characteristics such thickness, loss tangent, and dielectric constant.

3. MIMO (Multiple-Input Multiple-Output) Configuration:

Based on the particular requirements of the application, choose the MIMO configuration.

MIMO systems increase data throughput and reliability by using many antennas for data transmission and reception.

4. Radiation Box Design:

Design the radiation box to encircle the antenna assembly to shield it from external interference.

The radiation box ensures that the antenna will function alone, unhindered by external interference.

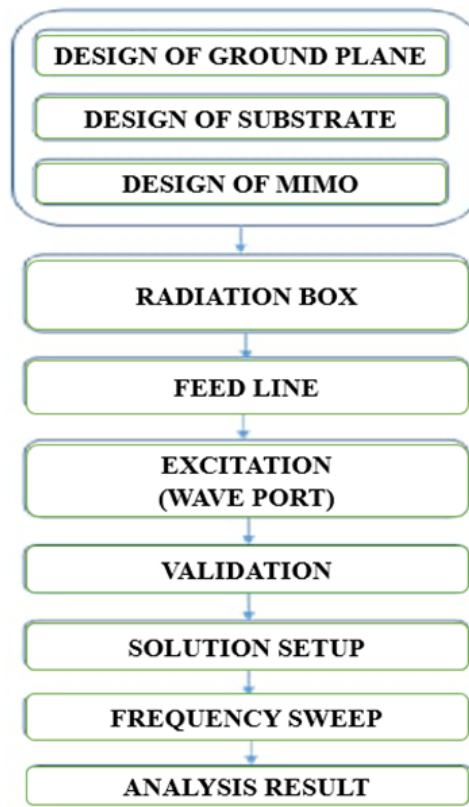

fig 1: flow chart

5. Feedline Design:

To connect the antenna and RF source, design the feedline.

In order to minimise signal loss, the feedline—which transmits RF energy from the source to the antenna—must be built.

6. Excitation Setup:

For the antenna simulation, set up the excitation parameters (frequency, amplitude, and phase).

The antenna's operation at the intended frequency and generation of the intended radiation pattern are guaranteed by the excitation setup.

7. Validation:

Use prototyping or simulation software to verify the antenna design.

Validation ensures that the antenna meets performance requirements and expected parameters.

8. Solution Setup:

Configure the simulation environment, taking into account the solver settings, boundary conditions, material properties, and antenna geometry.

An precise and effective simulation of the antenna performance is ensured by the solution setup.

9. Frequency Sweep:

To examine the antenna's performance across a spectrum of frequencies, conduct a frequency sweep.

Identification of resonance frequencies, bandwidth, and other performance measures is facilitated by frequency sweep.

10. Results Analysis:

Analyze the simulation data to ascertain the antenna's performance.

The results analysis takes into account parameters including efficiency, gain, radiation pattern, and return loss.

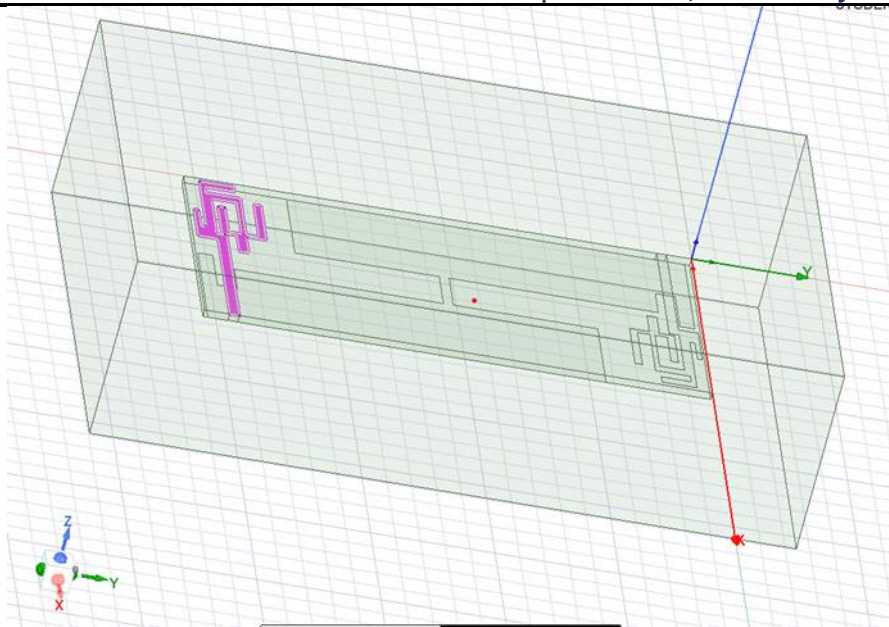

fig 2: design of MIMO antenna

Component	Dimensions (mm)
PCB Substrate Size	50 × 102
Antenna Element Area	24.5 × 14
FR4 Substrate Thickness	1.5
Strip-line Dimensions	28 × 2

RESULTS AND DISCUSSION

The study introduces a small dual-band MIMO antenna array with a frequency range of 2.5 GHz to 5.5 GHz that was created specifically for 5G smartphone applications. The array lowers interference in busy smartphone conditions and achieves great separation between antenna parts using unique design strategies, suggesting fidelity importance if handled. The work addresses the problem of supporting several 5G frequency bands while keeping a compact physical footprint consistent with smartphone form factors.

An essential outcome of the suggested MIMO antenna scheme's high reduction is the assurance of dependable communication performance across the whole frequency range of 2.5 GHz to 5.5 GHz in 5G devices. This research advances smartphone technology and makes it easier to seamlessly integrate 5G capabilities into portable devices by creating cutting-edge antenna technology for next-generation wireless communication systems. In order to evaluate antenna systems' performance in real-world application scenarios, more study might concentrate on testing smartphone models' antenna systems horizontally using MIMO antenna systems. A comparison with can give important information about the benefits that the suggested system offers.

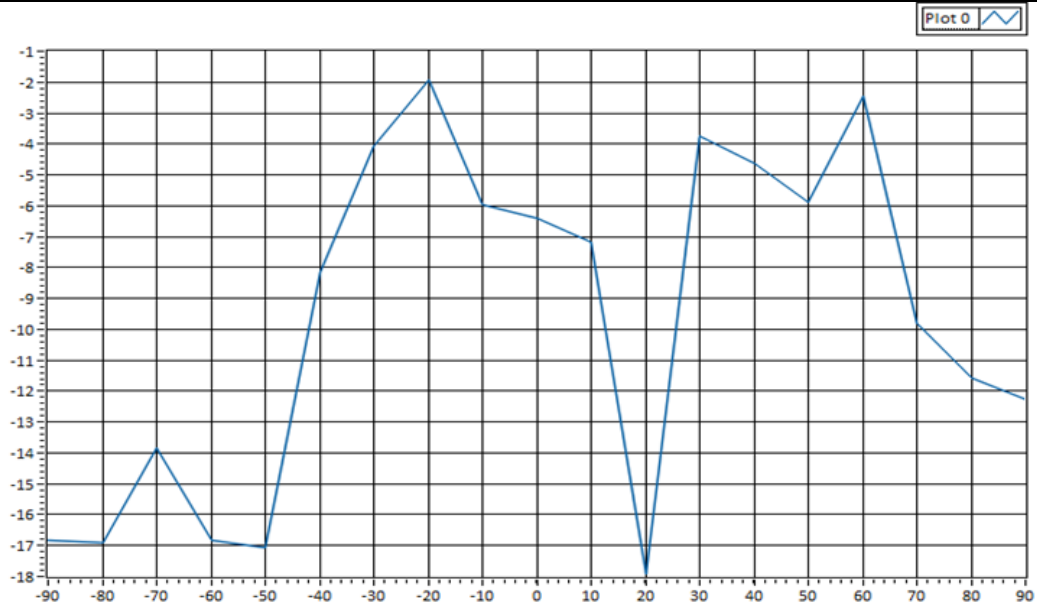

fig 3: E plane

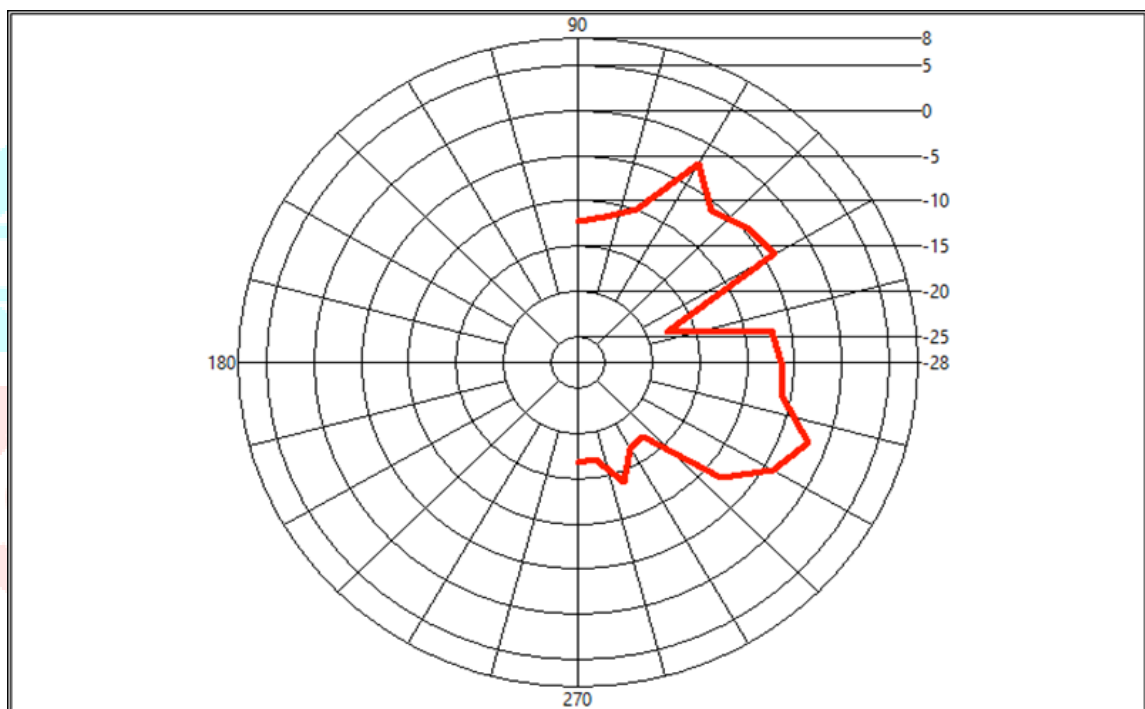

fig 4: E plane plot

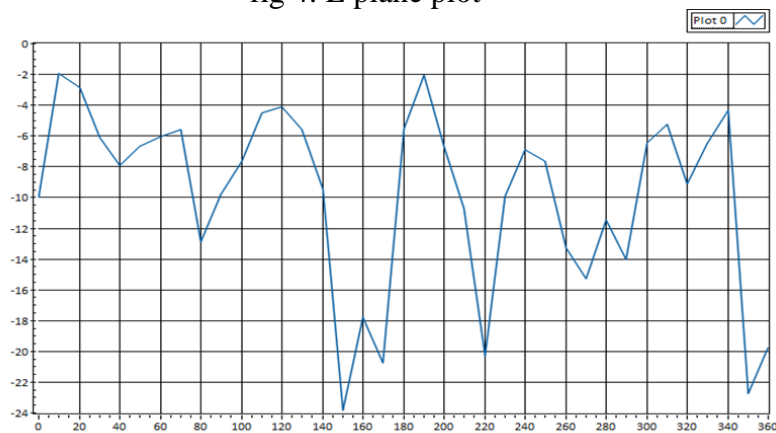

fig 5: H plane

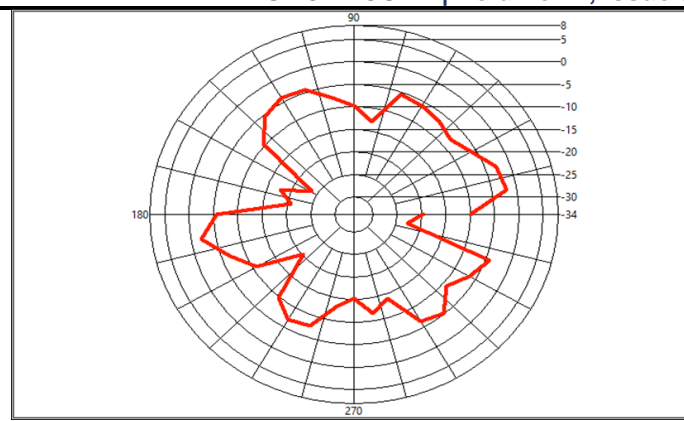

fig 6: H plane plot

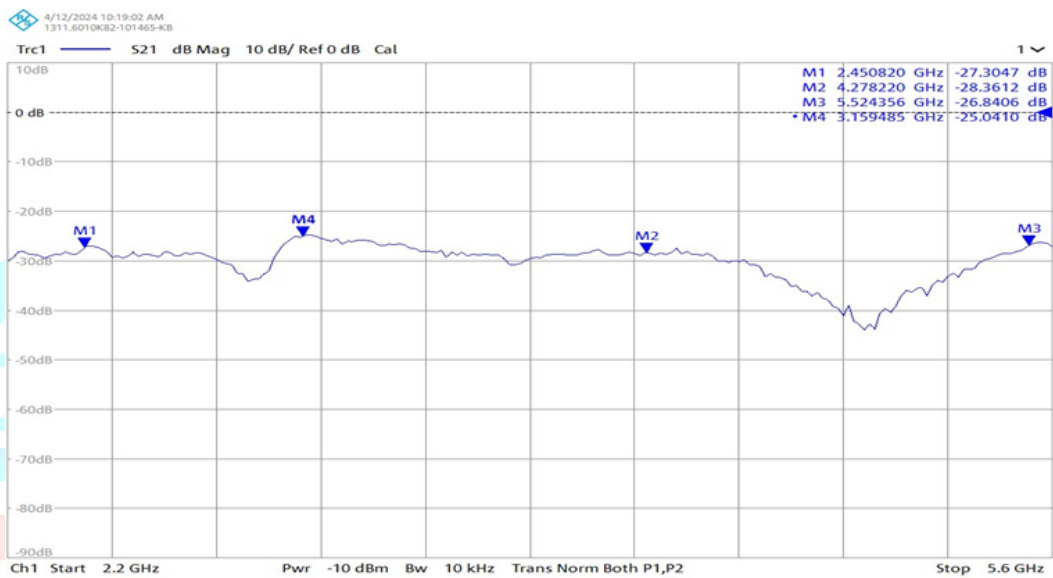

fig 7: simulated and measured S21 of proposed MIMO antenna system



fig 8: simulated and measured S11 of proposed MIMO antenna system

Conclusion

The field of MIMO (Multiple Input Multiple Output) antenna systems with superior isolation for smartphone applications offers numerous prospects for further study and development. The ongoing trend in smartphone design toward smaller, more streamlined form factors has increased demand for compact antenna systems that offer high performance without taking up excessive amounts of room. In order to achieve small-footprint MIMO systems, future research could focus on developing innovative antenna layouts and integration techniques.

Furthermore, even with recent improvements in antenna design, it is still difficult to achieve strong isolation between adjacent antenna elements, particularly in situations when smartphones are crammed into small spaces. To further improve isolation performance and reduce interference, future research can

investigate cutting-edge isolation approaches such as sophisticated substrate materials, electromagnetic bandgap structures, and adaptive tuning processes.

As 5G networks are implemented and new wireless communication standards and guarantees are developed, MIMO antenna systems that support higher data rates, longer bandwidths, and improved spectrum efficiency will become more and more crucial. Additionally, beamforming techniques are becoming more and more common in multiple-input multiple-output internal (MIMO) systems for transmitting wireless signals to specific users or instructions, increasing signal strength and spectral efficiency. Future studies can look at complex beamforming algorithms and implementation techniques made specifically for smartphone apps in order to maximize signal coverage and quality in dynamic scenarios. These methods will enable beamforming and adaptive beam steering.

In conclusion, the invention of a MIMO antenna system with strong isolation for smartphone applications is a significant advancement in wireless communication technology. By utilizing multiple antenna elements and cutting-edge signal processing techniques, MIMO systems offer better data speeds, improved reliability, and superior coverage when compared to conventional antenna setups. Increased distance between antenna elements ensures less interference and maximizes system performance, making it particularly suitable for densely populated smartphone environments.

REFERENCE

- [1] A High-Isolation MIMO Antenna System with Compact Dual-Band Capability for 5G Smartphone Use. The 2020 IEEE MTT-S International Microwave Workshop Series on Advanced Materials and Processes for RF and THz Applications (IMWS-AMP) was presented by Xiao-Ting Yuan, Zhe Chen, Jin Li, and Tao Yuan.
- [2] A MIMO antenna array for WiFi base stations using waveguide technology and a curved beam. Oliver Litschke, Edlira Stavrou, Christos Oikonomopoulos-Zachos, and Rens Baggen organized the 2017 International Workshop on Antenna Technology: Small Antennas, Innovative Structures, and Applications (IWAT).
- [3] Performance assessment of a space-limited MIMO antenna using a customized MIMO system. IEEE 5th Asia-Pacific Conference on Antennas and Propagation (APCAP), Xueliang Shi, Ming Zhang, Daqing Liu, Su Xu, Dali Qin, Huailin Wen, and Jun Wang.
- [4] Minimization of Self-Isolated MIMO Antenna System Dimensions for 5G Mobile Phone Uses. IEEE Antennas and Wireless Propagation Letters, Anping Zhao, Zhouyou Ren.
- [5] Low-SAR MIMO Antenna with Reconfigurable Structure Reutilization for 4G/5G Full-Screen Metal-Frame Smartphone Function. IEEE Antennas and Wireless Propagation Letters, Yixiang Fang, Ying Liu, Yongtao Jia, Junjie Liang, Huan Huan Zhang.
- [6] A small, highly isolated UWB MIMO antenna. 2016 IEEE International Symposium on Antennas and Propagation (APSURSI) organizers: Lanchao Zhang, Wenqi Liu, and Tao Jiang.
- [7] MIMO Antenna Decoupling Using Dummy Antennas for 5G Mobile Terminals. 2022 International Applied Computational Electromagnetics Society Symposium (ACES-China) / Yuke Guo, Jinghui Xue, and Luyu Zhao.