

Stability analysis and control of HEXAPOD robot using PID Controller

Gohil Jigarkumar Arjunbhai
G.H. Patel college of engineering & Technology
Anand, Gujarat

Abstract— In present system, for locomotion application vehicle-based robots, pick and place robots, AGVs (Automated Guided Vehicles) are used. Meanwhile Hexapod robots are used in many applications where a wheel based system is difficult to pass through terrain, mud or uneven surfaces. Hexapod robots is a creature like 6 leg robot which makes travel through terrain surfaces, so stability of the systems is most important task while walking/running on abnormal surfaces which makes human task easier and simple. Various algorithm and control systems studies are used to make the robot surface in stable condition while reaching at destination.

Keywords—Hexapod , PID Controller , Servo Motor , Arduino Mega , MATLAB , Stability and Control .

I. INTRODUCTION

Main reason to operate 6 legs robot with 18 Servo motors and 18 DOF (Degree of Freedom) to operate in terrain surfaces in locomotion application which is helpful to operate in surfaces like mud, concrete, slope. It is a simplest methodology to make system stable by implementing PID algorithm to a controller Accelerometer & Gyroscope sensor based Single Input Multi Output (SIMO) system or the stable locomotion of load and goods in military application as well in forest.

1.1 Block Diagram of System

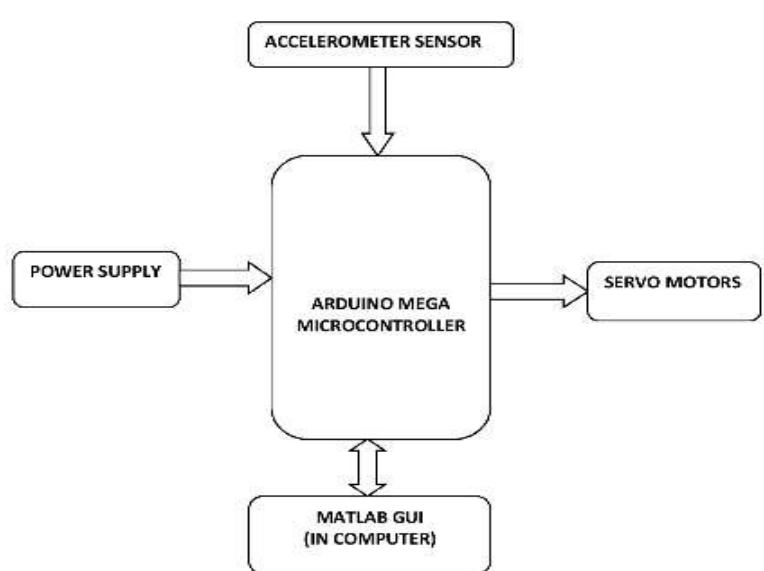

Fig.1 Block Diagram Of System

Arduino Mega controller is used in the proposed system here 18 servo motors outputs are driven by controller, angles are calculated and applied to the motor using algorithm values. Accelerometer/Gyroscope sensor is interfaced with the system to provide angle of hexapod top surface and thus gives feedback signal to the PID controller. Here system is interfaced to a MATLAB GUI.

1.2 Objective of project

- The main objective in proposed system is to make locomotion on terrain surfaces.
- Material handling through rock or uneven surfaces.
- Stability control using PID algorithm for hexapod top surface.
- MATLAB based path following using graph plotting.

II. HARDWARE AND SOFTWARE USED IN PROJECT

Table 1 gives the information about the hardware used in the project and software details provide in table 2.

Table 1: Hardware used in project

Sr. No	Name Of Hardware	Quantity	Specifications	Role in the project
1	Arduino Mega	1	ATmega1280 Operating voltage- 5V Digital pins54 (of which 15 provide PWM output)	controller.
2	Hexapod Robot	1	18 Servo motors	For running robot
3	Wiredin	1	RF module	For Wireless
4	Gyroscope	1	Angle data	Stability

III. HEXAPOD ROBOT STSTEM

A. Methodology

3.1 Hexapod running algorithm

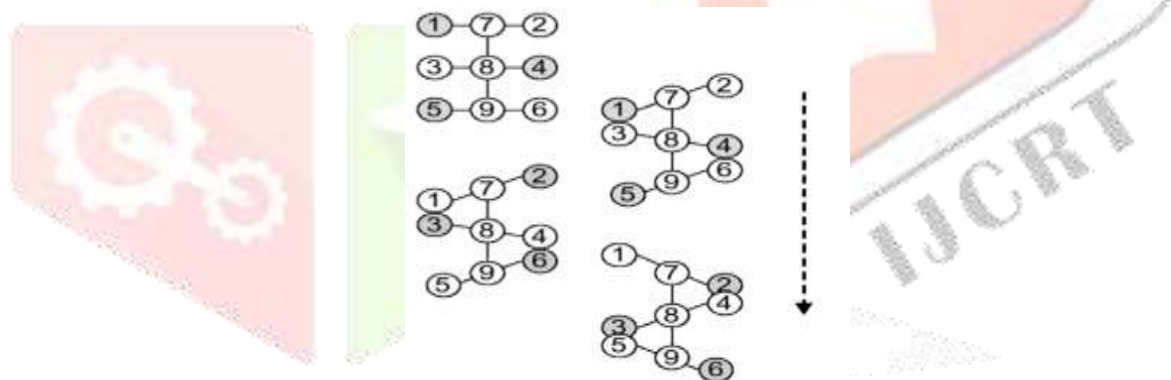

Fig 2: Walking Algorithm

Follow below mentioned algorithm steps to run hexapod robot

Step-1: Legs 1, 4 and 5 down,

Legs 2, 3 and 6 up

Step-2: Rotate 1, 4 and 5 clockwise,

Step-3 Legs 1, 4 and 5 up,

Legs 2, 3, and 6 down

Step-4 Rotate 2, 3 and 6 counter clockwise

Go to step 1

B. Flowchart of a system

Below Figure shows the flowchart of the system. It shows how the system operate in sequence.as show in chart first step of system is microcontroller send a command to the hexapod as per the code which we load to it.then all the servo motor initialize as per algorithm after that left and right leg of robot are set to stationary position then it set the steps and path to be follow. Then it get the angles from the gyroscope and using that reading it set the angles of the hexapod robot using PID technique.it start the running as per step which are define in the code.

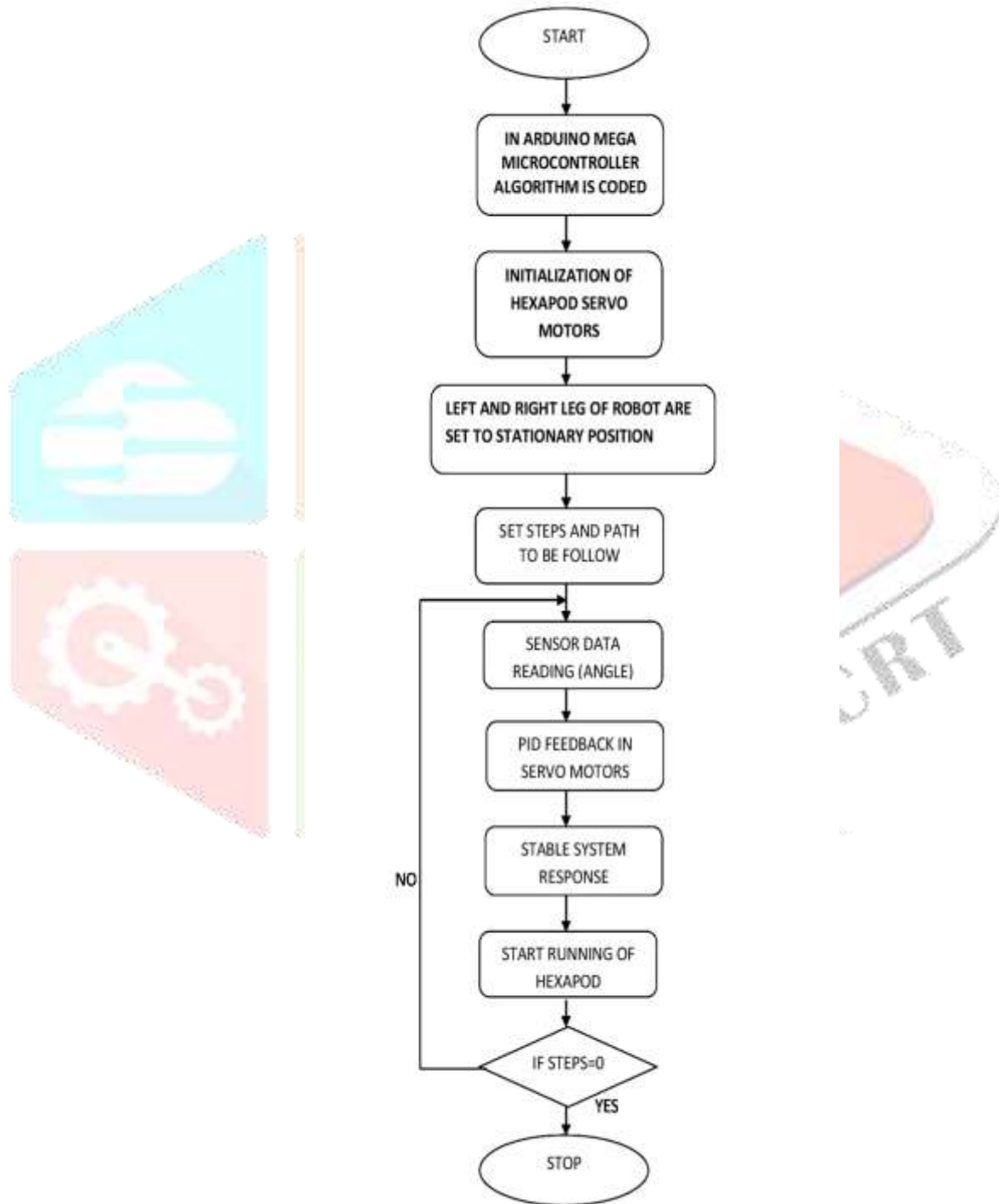

Fig 3: Flowchart of a system

VI. COMPONENTS DETAILS

A.ARDUINO MEGA 2560

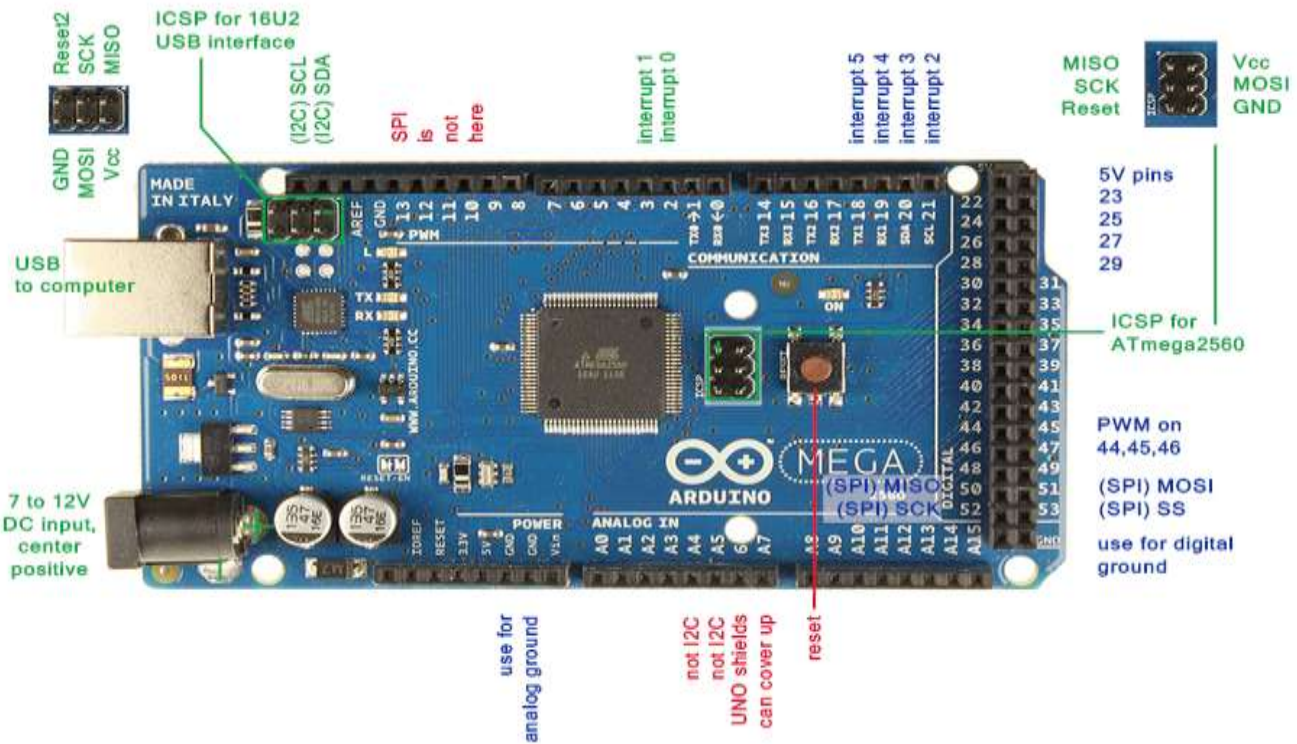

Fig 4: Arduino Atmega2560

Pin Functions

- Serial: 0 (RX) and 1 (TX); Serial 1: 19 (RX) and 18 (TX); Serial 2: 17 (RX) and 16 (TX); Serial 3: 15 (RX) and 14 (TX). Used to receive (RX) and transmit (TX) TTL serial data. Pins 0 and 1 are also connected to the corresponding pins of the FTDI USB-to-TTL Serial chip.
- External Interrupts: 2 (interrupt 0), 3 (interrupt 1), 18 (interrupt 5), 19 (interrupt 4), 20 (interrupt 3), and 21 (interrupt 2). These pins can be configured to trigger an interrupt on a low value, a rising or falling edge, or a change in value. See the attachInterrupt () function for details.
- PWM: 2 to 13 and 44 to 46. Provide 8-bit PWM output with the analogWrite() function.
- SPI: 50 (MISO), 51 (MOSI), 52 (SCK), 53 (SS). These pins support SPI communication, which, although provided by the underlying hardware, is not currently included in the Arduino language. The SPI pins are also broken out on the ICSP header, which is physically compatible with the Duemilanove and Diecimila.
- LED: 13. There is a built-in LED connected to digital pin 13. When the pin is HIGH value, the LED is on, when the pin is LOW, it's off.
- I2C: 20 (SDA) and 21 (SCL). Support I2C (TWI) communication using the Wire library (documentation on the Wiring website). Note that these pins are not in the same location as the I2C pins on the Duemilanove or Diecimila.

B.GYROSCOPE(MPU6050)



Fig 5: MPU6050

Features

- I2C Digital-output of 6 or 9-axis Motion Fusion data in rotation matrix, quaternion, Euler Angle, or raw data format
- Input Voltage: 2.3 - 3.4V
- Selectable Solder Jumpers on CLK, FSYNC and ADO
- Tri-Axis angular rate sensor (gyro) with a sensitivity up to 131 LSBs/dps and a full-scale range of ± 250 , ± 500 , ± 1000 , and ± 2000 dps
- Tri-Axis accelerometer with a programmable full scale range of $\pm 2g$, $\pm 4g$, $\pm 8g$ and $\pm 16g$

C. HEXAPOD ROBOT

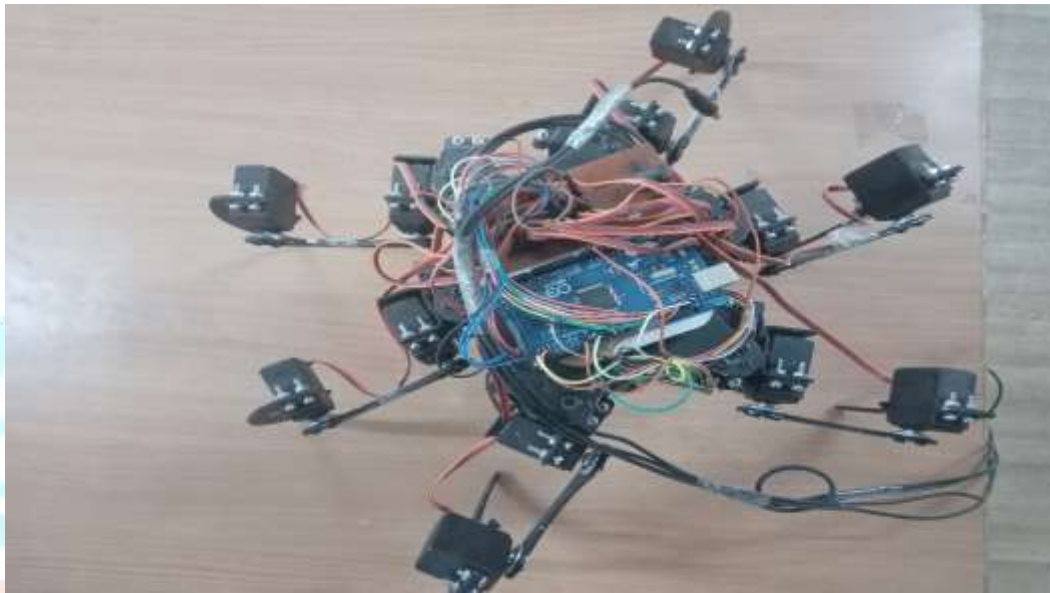

Fig 6: Hexapod Robot

- Six-legged walking robot should not be confused with a Stewart platform, a kind of parallel manipulator used in robotics applications.
- A hexapod robot is a mechanical vehicle that walks on six legs. Since a robot can be statically stable on three or more legs, a hexapod robot has a great deal of flexibility in how it can move. If legs become disabled, the robot may still be able to walk. Furthermore, not all of the robot's legs are needed for stability; other legs are free to reach new foot placements or manipulate a payload.
- Many hexapod robots are biologically inspired by Hexapod locomotion. Hexapods may be used to test biological theories about insect locomotion, motor control, and neurobiology.

V.RESULTS

A. MATLAB with Hexapod robot



Fig 7: Matlab Results

Arduino Mega is controlled using MATLAB GUI interfacing with controller, here HEXAPOD robot is connected and operated using MATLAB. A GUI panel is created as shown in Fig.4.1. Forward pushbutton function allows to run robot in forward direction, rotate option allows to rotate robot in right hand side direction as shown in Figure.

B.ARDUINO UNO WITH HEXAPOD



Fig 8: Arduino interfacing with hexapod

For stability control and analysis of a robot a feedback signal is provided by MPU6050 sensor. Sensor data acquisition result is shown in Figure no. here sensor three parameters data are available ROLL, PITCH and YAW. Systems uses ROLL data as a feedback signal in controller.

a. Implementing PID to DC servo motor without PID

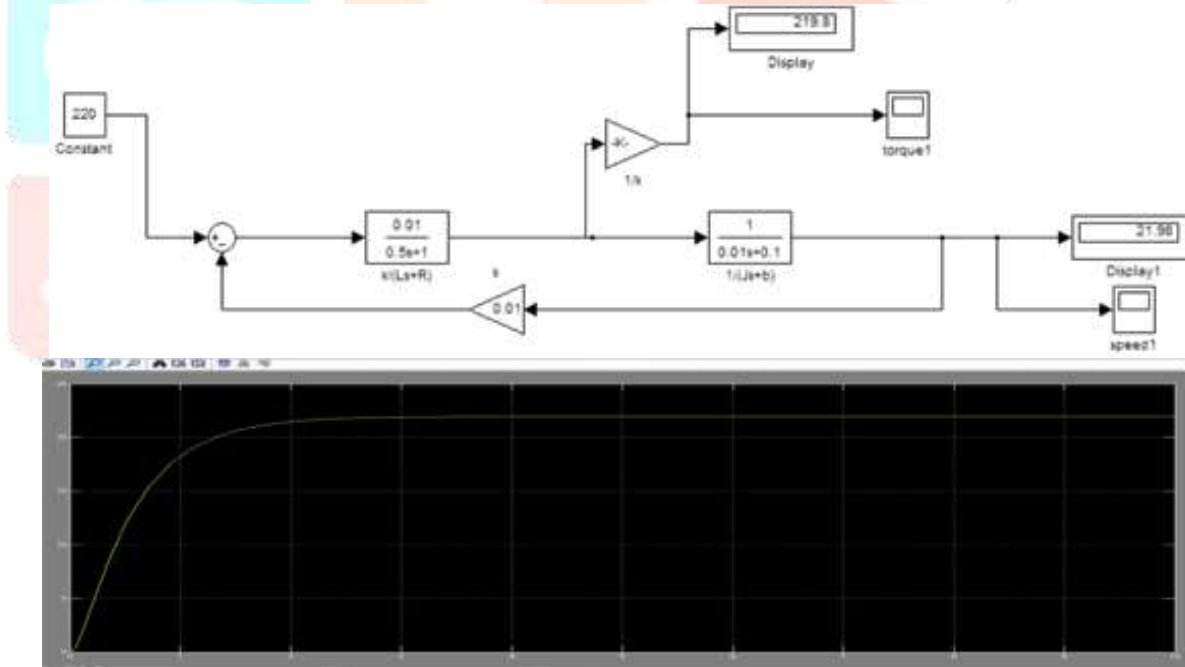

Fig 9: Servo output without PID

b. Implementing PID to DC servo motor with PID

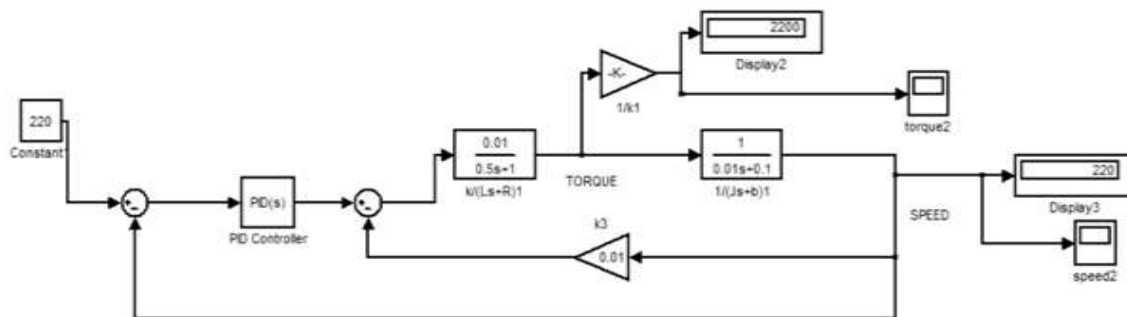

Fig 10: Servo output with PID

C. Wiridin RF module based wireless system



Fig 11: Arduino interfacing with hexapod

a. Implementing PID to 12 motors in hexapod

```

#include <Servo.h>
#include <PID_v1.h>
double Setpoint, Inset, Output;
double Kp=2, Ki=5, Kd=1;
PID myPID(input, output, setpoint, Kp, Ki, Kd, output);

Servo myservo11; // create servo object to control a servo
Servo myservo12; // create servo object to control a servo
Servo myservo13; // create servo object to control a servo
Servo myservo21; // create servo object to control a servo
Servo myservo22; // create servo object to control a servo
Servo myservo23; // create servo object to control a servo
Servo myservo31; // create servo object to control a servo
Servo myservo32; // create servo object to control a servo
Servo myservo33; // create servo object to control a servo
//left side
Servo myservo11; // create servo object to control a servo
Servo myservo12; // create servo object to control a servo

```

Fig 12: Arduino interfacing with hexapod

b. Implementing PID for stability on uneven surface.



Figure 13: Stability on uneven surfaces

REFERENCES

- [1] Dariusz Grzelczyk , Bartosz Stanczyk , Jan Awrejcewicz “Prototype, control system architecture and controlling of the hexapod legs with nonlinear stick-slip vibrations” *Mechatronics* 37 (2016) 63–78
- [2] I.S. Jacobs and C.P. Bean, “Fine particles, thin films and exchange anisotropy,” in *Magnetism*, vol. III, G.T. Rado and H. Suhl, Eds. New York: Academic, 1963, pp. 271-350.
- [3] Andrea Cirillo a, Pasquale Cirillo a,n, Giuseppe De Maria a, Alessandro Marino b, Ciro Natale a, Salvatore Pirozzi” Optimal custom design of both symmetric and unsymmetrical hexapod robots for aeronautics applications” *RoboticsandComputer-IntegratedManufacturing*44(2017)1–16
- [4] Takuma Nemoto, Rajesh Elara Mohan, Masami Iwase” Energy-based control for biologically inspired hexapod robot with rolling locomotion” *Digital CommunicationsandNetworks*(2015) 1, 125–133
- [5] Haibo Gao, Ma Jin, Liang Ding, Yiqun Liu , Weihua Li , Xinyi Yu c , Zongquan Deng a , Zhen Liu “ A real-time, high fidelity dynamic simulation platform for hexapod robots on soft terrain” *Simulation Modelling Practice and Theory* 0 0 0 (2016) 1–21
- [6] F. Martínez-Morenoa, G. Figueiredob, E. Lorenzoa” In-the-field PID related experiences” *Solar Energy Materials and Solar Cells* 174 (2018) 485–493