

Power Quality Improvement using Shunt Active Power Filter Operating With Unbalanced Loads

Appanna E

Department of Electrical Engineering

Anil neerukonda institute of technology and sciences

Visakhapatnam, India

Tulasi rao B

Department of Electrical Engineering

Anil neerukonda institute of technology and sciences

Visakhapatnam, India

Abstract-- Filtering is the significant criteria to keep up power quality improvement in the three stage three wire framework. Presently Active powers Filters (APF) are generally preferable for this reason. Traditional PI control techniques are disadvantageous in killing high harmonics, created by the second harmonics at the DC link of a shunt APF. This paper proposes PR control strategy which invalidates second harmonics and provides better execution exactness contrasted with the conventional positive-succession control technique and Dc link voltage control technique separately regarding quality improvement and cost adequacy. The execution of the proposed technique is shown through reproduction and test comes about.

Index Terms-- Shunt active power filter (APF), 2nd harmonic, control methods, proportional integral control (PI), Proportional resonant control (PR), unbalanced and nonlinear load

A. INTRODUCTION

Step by step our requirements are expanded as far as power. Necessity will make trouble on power quality. Presently a day the vast majority of the heaps are nonlinear because of utilization of power electronic devices like semiconductor devices utilized as a part of rectifiers and inverters, switching power supply and other power electronic converters. To overcome above problems shunt APF is perceived as savvy answer for repaying harmonics in low and medium power applications.

By and large PI controllers are assuming real part to control shunt APF. For three stage Systems synchronous frame PI controllers can be utilized however it requires computational weight if there should be an occurrence of different frame changes. To overcome above we are preferred to utilize Proportional resonant controller, which is having comparative frequency response characteristics. PR controllers are utilized for reference tracking as a part of the stationary reference frame. The fundamental usefulness of a PR controller is to present infinite gain at a chose resonant frequency for taking out steady state error at that frequency. Theoretically, an integrator whose DC gain compels the DC steady state error to zero similarly resonant bit of the PR controller whose AC gain (GI) constrains the AC steady error to zero. Due to above focal points go for PR control technique. Under an unbalanced load the fundamental positive and negative-sequence segments will present into the system. The interaction of positive and negative sequence part of switching capacities and AC currents of the APF produces 2nd harmonic

ripple on the DC link of the APF, which will infuse 3rd harmonic segment in the AC currents of the APF and line currents. In addition nonlinear load will infuse high harmonic segments into the load current. The interaction of positive and negative sequence switching capacities and high harmonic AC currents of the APF produces high order even harmonics on the DC link voltage of the APF, which make high order odd harmonics into the APF AC currents. It will lead to deterioration of execution of the system. It will provide more weight on the dc link capacitor, which will reduce life cycle of the dc link capacitor [1-3].

A few methods are proposed in the papers [1], [5] and [6] to improve execution of the system. Methods, which are proposed in the above papers, are used to wipe out just the 3rd harmonic of APF AC current, consequently to reduce the distortion of the line current however high harmonics can't be reduced, Moreover the even harmonics on the DC link side still exist

By utilizing customary positive sequence control method we can't wipe out 2nd harmonic voltage totally from the DC link voltage. Proposed method in the paper [2] can kill 2nd harmonic voltage totally from the DC link. In any case, the controller is unpredictable.

To overcome above disadvantages of the control method and arrangement harmonics at both DC side and AC side of the APF, PR Control method is proposed in this paper. This method is implemented with straightforward controller. PR filters can likewise be used for creating the harmonic command reference precisely in an active power filter, particularly for single-phase systems, where d-q transformation hypothesis is not directly relevant. Another advantage associated with the PR controllers and filters is the possibility of implementing selective harmonic compensation without requiring excessive computational resources.

The remainder of the paper is organized as follows section 2 describes mathematical modeling of active power filter, section 3 presents control strategy. Finally, the simulation results and conclusion are given in section 4.

B. MATHEMATICAL MODEL

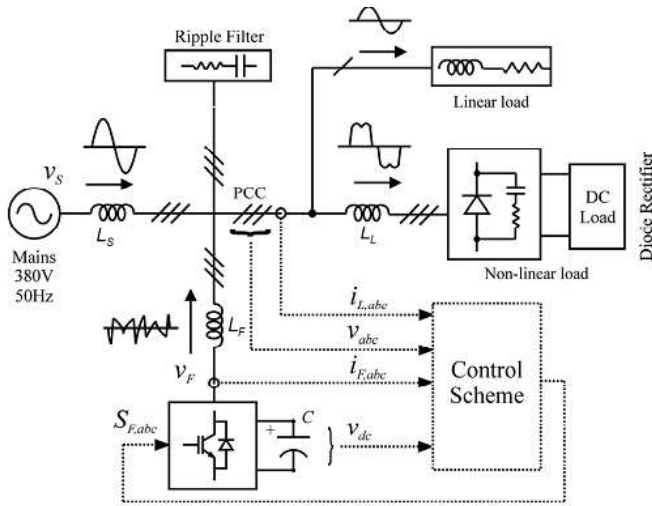

Fig.1 Basic current harmonic scheme of an unbalanced load using a shunt APF.

$$\vec{i}_d^* = A_2 \varepsilon_2 \sin(2\omega_e t + \beta_i) = \frac{A_i}{2} (e^{j(2\omega_e t + \beta_i)} - e^{-j(2\omega_e t + \beta_i)}) \quad (4)$$

Where $A_i = A_2 \varepsilon_2$, ε_2 is the error of the voltage control loop and subscript “*” means reference value.

From equation (4) it can be seen that 2nd harmonic component still exist in reference current, which we are getting from output of the PI controller. The output of the APF current compensator is obtained as

$$\vec{v}_{dq} = \frac{A_v}{2} \sin(2\omega_e t + \beta_v) = \frac{A_v}{2} (e^{j(2\omega_e t + \beta_v)} - e^{-j(2\omega_e t + \beta_v)}) \quad (5)$$

Transforming equation (5) into the form in $\alpha\beta$ stationary frame, equation (5) is written as

$$\vec{v}_{\alpha\beta} = \vec{v}_{dq} e^{j\omega_e t} = \frac{A_v}{2} (e^{j(3\omega_e t + \beta_v)} - e^{-j(\omega_e t + \beta_v)}) \quad (6)$$

In equation (6) the 3rd harmonic part shows up in the APF current such harmonic results in a 4th harmonic on the DC link voltage and DC link current of the APF, which causes high order harmonic in the APF AC currents. These harmonic flows into the line and deteriorates the execution of the system.

In addition under the nonlinear load, load current contains the fundamental negative sequence segment, as well as high order harmonics $6k \pm 1$, where $k = 0, 1, 2, \dots$. interaction of these high order harmonics and fundamental negative and positive sequence segments leads to a progression of high harmonics $2k$, $k = 0, 1, 2, \dots$ at DC link, e.g., 2nd, fourth, sixth, ...

Three phase proportional resonant (PR) exchange capacities are used for the detachment of positive and negative sequence segments. When all is said in done proportional basic exchange capacities are used for the division of positive and negative sequence segments however it requires transformation from stationary reference frame ($\alpha\beta$) to synchronous reference frame (dq), which will expand the computational exertion. Subsequently we use PR move capacities as far as stationary reference frame. Here we need to do turn around transformation from dq to $\alpha\beta$. The inverse transformation can be performed by using the following 2×2 matrix:

$$G_{\alpha\beta}(s) = \frac{1}{2} \begin{bmatrix} G_{dq1} + G_{dq2} & jG_{dq1} - jG_{dq2} \\ -jG_{dq1} + jG_{dq2} & G_{dq1} + G_{dq2} \end{bmatrix} \quad (7)$$

Where $G_{dq1} = G_{dq}(s+j\omega)$

$G_{dq2} = G_{dq}(s-j\omega)$

Given that $G_{dq}(s) = K_p + K_i/s$ and $G_{dq}(s) = K_p + K_i/(1 + (s/\omega_c))$, the equivalent controllers in the stationary frame for compensating for positive-sequence feedback error are therefore expressed as:

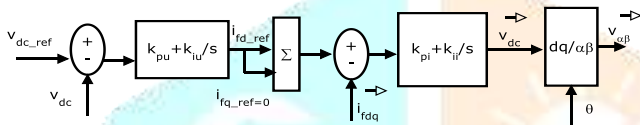

Fig.2 The conventional PI control Diagram.

Average current flowing through DC link of the APF under an unbalanced load is [2]

$$I_{dc} = \frac{3}{2} [\text{Re}\{\vec{d}_{dq}^{+1} \vec{i}_{dq}^{+1} + \vec{d}_{dq}^{-1} \vec{i}_{dq}^{-1}\} + \text{Re}\{e^{j\omega_e t} (\vec{d}_{dq}^{+1} \vec{i}_{dq}^{-1})\} + \text{Re}\{e^{-j\omega_e t} (\vec{d}_{dq}^{-1} \vec{i}_{dq}^{+1})\}] \quad (1)$$

DC link voltage of APF [2]

$$V_{dc} = \frac{3}{4C} [I_{dc} + \frac{I_2}{2\omega_e} \sin(2\omega_e t - \alpha_2)] \quad (2)$$

Where I_2 is magnitude of second harmonic component of DC link current of the APF. We can represent equation (2) in the form of

$$u_{dc} = U_{dc} + A_{u_{dc}} \sin(2\omega_e t + \alpha_{u_{dc}}) \quad (3)$$

Where i_{dq}^{+1} , i_{dq}^{-1} are conjunction vector positive and negative sequence parts of APF currents in the pivoting synchronous frame, individually d_{dq}^{+1} , d_{dq}^{-1} are vector of switching capacity positive and negative sequence in the turning synchronous frame, separately. From (2), we can tell that the 2nd harmonic ripple shows up on the DC link terminal due to the interaction of positive and negative sequence segments of information currents with switch capacities.

Since DC link voltage contains the 2nd harmonic in (2), the yield of the PI controller of DC link voltage, i.e., the reference current for APF current circle, can be given as (DC thing is neglected).

$$G_{\alpha\beta^+}(s) = \frac{1}{2} \begin{bmatrix} K_p + \frac{2K_i s}{s^2 + \omega^2} & -\frac{2K_i \omega}{s^2 + \omega^2} \\ \frac{2K_i \omega}{s^2 + \omega^2} & K_p + \frac{2K_i s}{s^2 + \omega^2} \end{bmatrix} \quad (8)$$

$$G_{\alpha\beta^+}^{-1} \approx \frac{1}{2} \begin{bmatrix} K_p + \frac{2K_i \omega s}{s^2 + 2\omega_c s + \omega^2} & \frac{2K_i \omega}{s^2 + 2\omega_c s + \omega^2} \\ -\frac{2K_i \omega}{s^2 + 2\omega_c s + \omega^2} & K_p + \frac{2K_i \omega s}{s^2 + 2\omega_c s + \omega^2} \end{bmatrix} \quad (9)$$

Similarly, for compensating for negative sequence feedback error, the required transfer functions are expressed as:

$$G_{\alpha\beta^-}(s) = \frac{1}{2} \begin{bmatrix} K_p + \frac{2K_i s}{s^2 + \omega^2} & 0 \\ 0 & K_p + \frac{2K_i s}{s^2 + \omega^2} \end{bmatrix} \quad (10)$$

$$G_{\alpha\beta^-}^{-1} \approx \frac{1}{2} \begin{bmatrix} K_p + \frac{2K_i \omega s}{s^2 + 2\omega_c s + \omega^2} & -\frac{2K_i \omega}{s^2 + 2\omega_c s + \omega^2} \\ \frac{2K_i \omega}{s^2 + 2\omega_c s + \omega^2} & K_p + \frac{2K_i \omega s}{s^2 + 2\omega_c s + \omega^2} \end{bmatrix} \quad (11)$$

Comparing equations (8) and (9) with (10) and (11). It is noted that the diagonal terms of $G_{\alpha\beta^+}(s)$ and $G_{\alpha\beta^-}(s)$ are identical, but there non-diagonal terms are opposite in polarity. This is inversion of polarity can be viewed as equivalent to the reversal of rotating direction between the positive – and negative-sequence synchronous frames.

Combining both the equations, the resulting controllers for compensating for both positive- and negative- sequence feedback errors are as expressed as:

$$G_{\alpha\beta}(s) = \frac{1}{2} \begin{bmatrix} K_p + \frac{2K_i s}{s^2 + \omega^2} & 0 \\ 0 & K_p + \frac{2K_i s}{s^2 + \omega^2} \end{bmatrix} \quad (12)$$

$$G_{\alpha\beta}^{-1} \approx \frac{1}{2} \begin{bmatrix} K_p + \frac{2K_i \omega s}{s^2 + 2\omega_c s + \omega^2} & 0 \\ 0 & K_p + \frac{2K_i \omega s}{s^2 + 2\omega_c s + \omega^2} \end{bmatrix} \quad (13)$$

Equations (7- 13) are getting from [3]

In this paper I have used equations (9) and (11) for separation of positive- and negative-sequences in the PR control method.

C. CONTROL STRATEGY

Our control system is to kill 2nd harmonic at the DC link voltage of the APF under an unbalanced load condition. As from above investigation, the fundamental negative sequence part is the explanation behind production of high harmonics in the line current and also DC side of the APF. In this way, we must be diminished the fundamental negative sequence segment of APF, along these lines, drop the harmonics in the system. In order to understand this article, we need to keep up quadrature part of fundamental positive sequence reference current, which is the yield of PI controller of voltage control circle, and both the direct and quadrature segment of fundamental negative sequence reference current must be zero.

$$i_d^{+1*} = 0 \text{ and } i_{dq}^{-1*} = 0 \quad (7)$$

This is the premise for a PR control method of the APF. The new control method square diagram for the APF system is appeared in Fig.3. It is having two control circles in the general system. External circle is the voltage control circle, which manages the DC link voltage of the APF to the reference esteem. The inward circle includes the fundamental current controller and high harmonic controller. If there should arise an occurrence of customary positive sequence control method and DC link voltage control method PI controller is used in fundamental current controller and PR controller is used in high harmonic current controller.

If there should be an occurrence of PR control method PR controller is used in both the fundamental sequence current controller and high harmonic current controller. This control method will reduce the multifaceted nature of the circuit. The PR control method is compared with the traditional control method and DC link voltage control method. The DC link voltage control method piece diagram is given in Fig.4 joining [1] with [2].

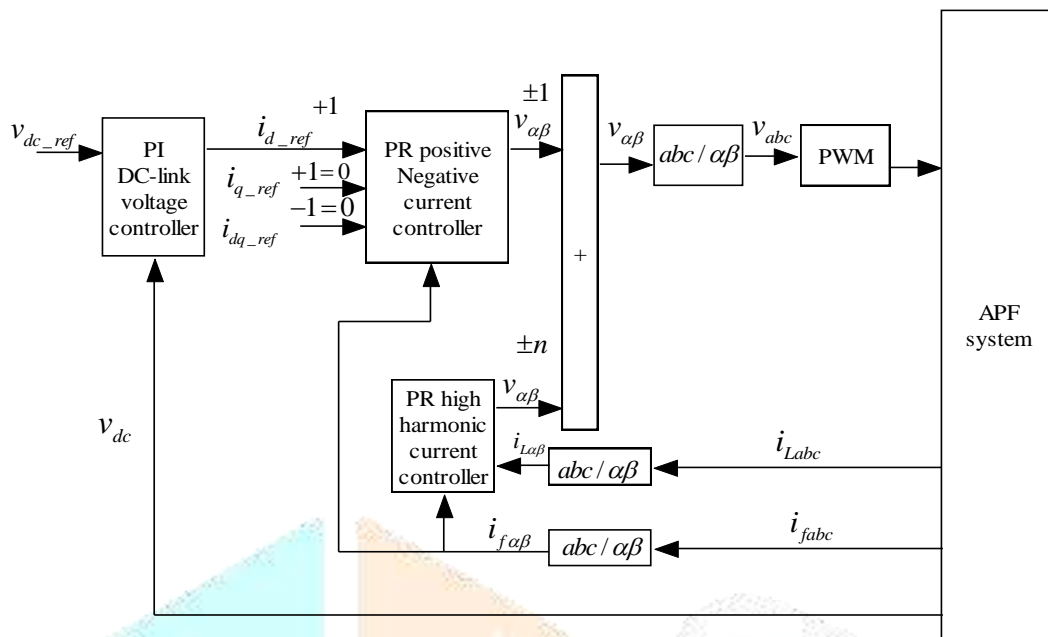

Fig.3 Model of Proposed PR control method.

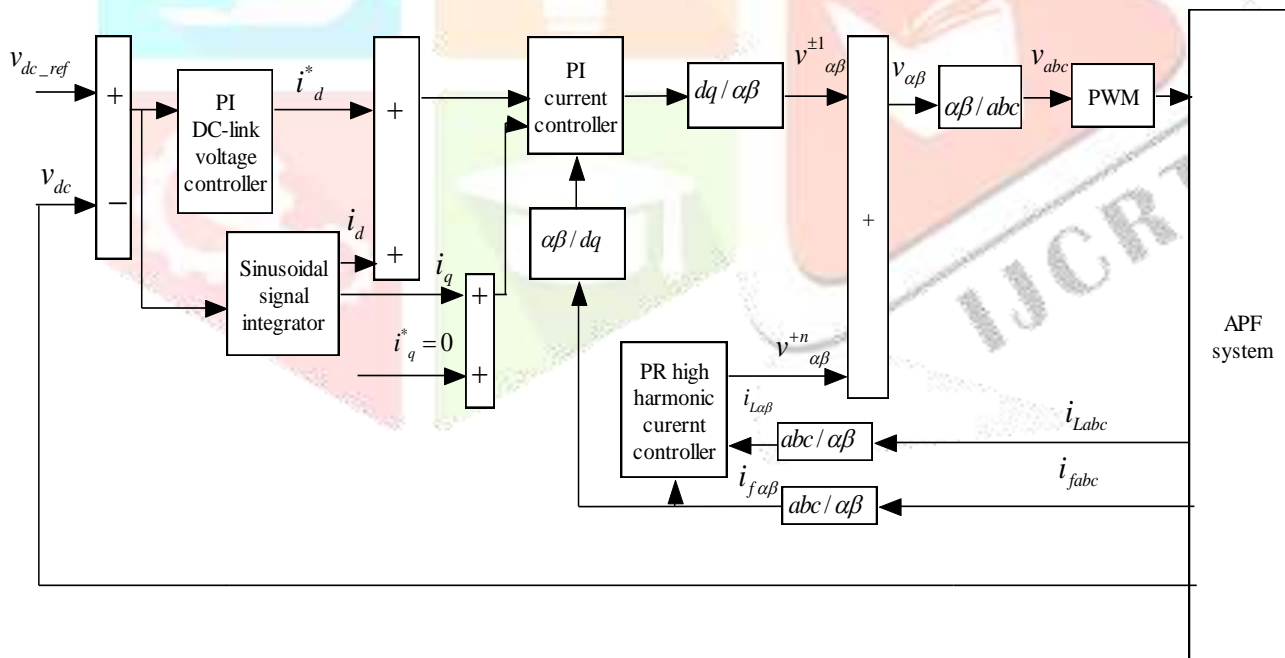

Fig.4 Model of DC link voltage control method.

D. SIMULATION RESULTS AND COMPARISON

Simulation results of PR control method are compared with the conventional positive sequence control method and DC link

voltage control method. Here we are looking at THD (total harmonic Distortion), 3rd harmonics and 2nd, fourth, sixth harmonic parts at the DC link. Just about we are getting same results for both DC link Voltage control method and PR control method. The simulation results of the APF are shown in Table I.

TABLE I
PARAMETERS OF THE APF

Parameters	Value	Parameters	Value
I_{sa}	0.2856mH	r_{sa}	91mΩ
C_{dc}	0.35mF	U_{dc_ref}	700V
I_a	10 mH	r_a	1mΩ

1. Conventional positive sequence control method:

In the conventional positive sequence control method positive sequence is controlled. Negative sequence is not regulated. From the Fig.5, Fig.6 and Fig.7, we can see line current, DC link voltage and repaying current. Fig.8 (a) and (b) will demonstrate THD of line current and Harmonic content of DC link voltage.

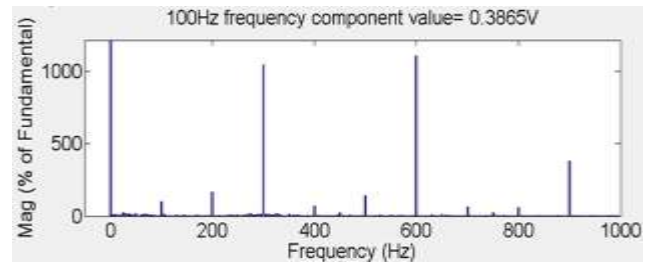

Fig. 8 (b) Harmonic content of the DC link voltage

2. DC link voltage control method:

We can control positive and negative sequences are controlled. PI controllers are used for controlling of both positive and negative sequences. From the Fig.9, Fig.10 and Fig.11, we can see line current, DC link voltage and Compensating current of APF. Fig.12 (a) and (b) will demonstrate THD of line current and Harmonic content of DC link voltage.

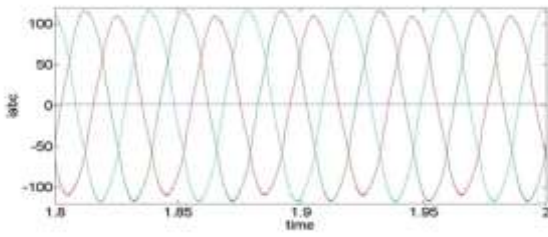

Fig. 5 line current.

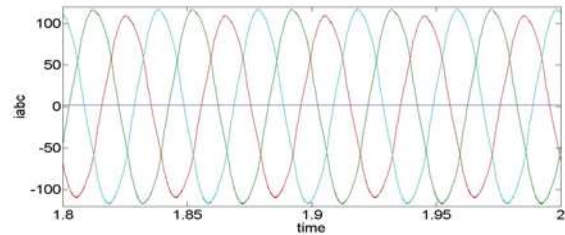

Fig. 9 line current.

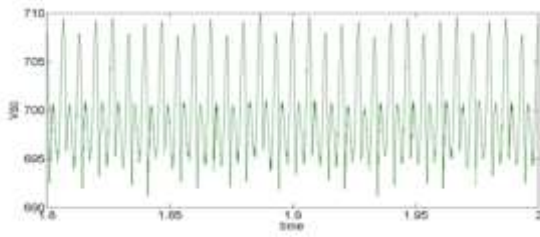

Fig. 6 DC link voltage.

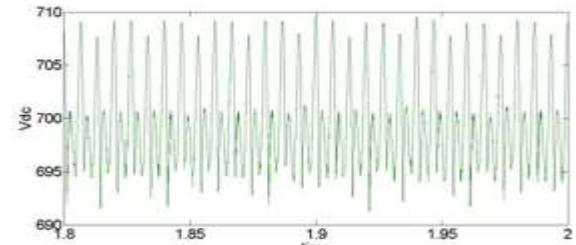

Fig. 10 DC link voltage.

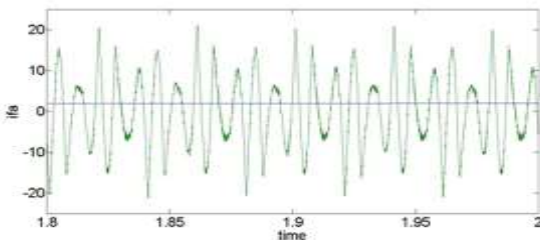

Fig. 7 Compensating current.

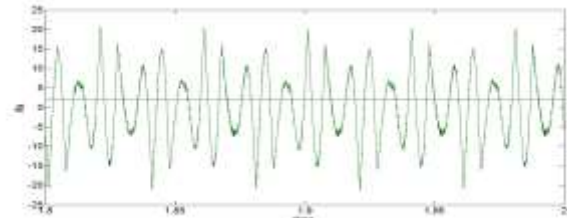

Fig. 11 Compensating current.

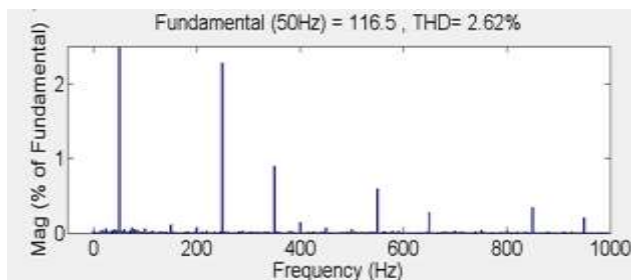

Fig. 8 (a) THD of line current

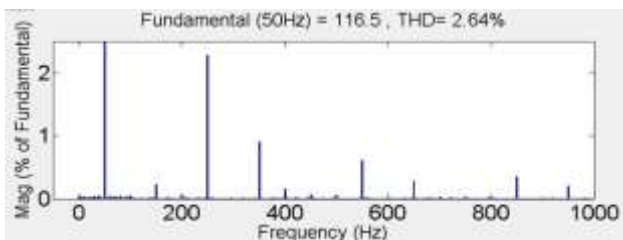

Fig. 12 (a) THD of line current

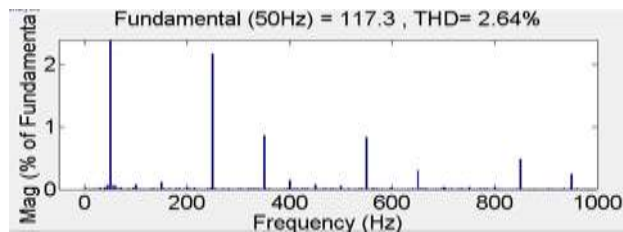

Fig. 16 (a) THD of line current

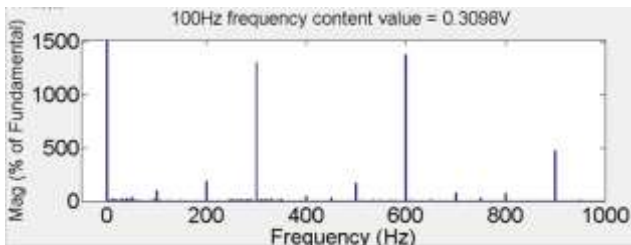

Fig. 12 (b) Harmonic content of DC link voltage

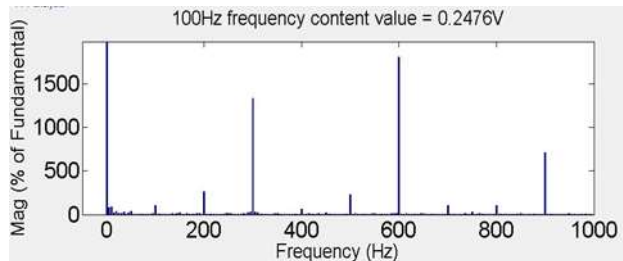

Fig. 16 (b) Harmonic content of DC link voltage.

3. Proportional Resonant (PR) control method:

PR controllers are used for the controlling of both positive and negative sequences. From the Fig.13, Fig.14 and Fig.15, we can see line current DC link voltage and remunerating current. Fig.16 (a) and (b) will demonstrate THD of line current and harmonic content of DC link voltage.

The AC current THD and ripple of DC link voltage of the three controllers are appeared in Table II

TABLE II

Comparison between three control methods

	Conventional positive sequence control	DC link voltage control	PR control
AC current THD	2.64%	2.66%	2.64%
3 rd harmonic current	0.1368A	0.2591A	0.1335A
Ripple of DC voltage (V)	1) 2 nd harmonic(0.3865V) 2) 4 th harmonic(0.6372V) 3) 6 th harmonic(4.032V)	1) 0.3098V 2) 0.5727V 3) 4.016V	1) 0.2476V 2) 0.6393V 3) 3.3V

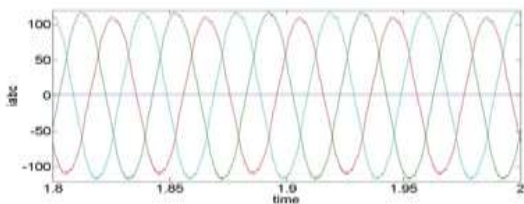

Fig. 13 Line current.

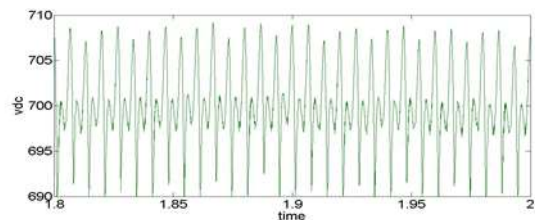

Fig. 14 DC link voltage.

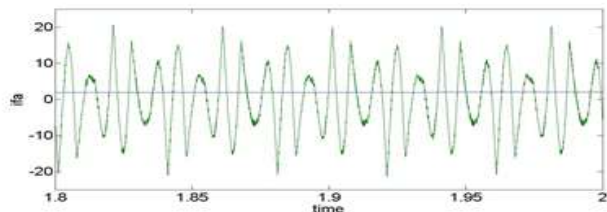

Fig. 15 Compensating current.

E. CONCLUSION

In this paper, examination between ordinary positive-sequence, DC link voltage control and PR control methods are discussed based on THD and 3rd harmonic segment of line current and ripple of DC link voltage. The simulation comes about uncover that distortions caused by the 3rd order harmonics hanging in the balance current and by 2nd ripple on the DC link are nullified, consolidating with the ordinary positive-sequence control method.

Despite the fact that DC voltage control methodology can't alleviate the 3rd order harmonic at stake current and 2nd ripple at the DC link, the PR control method is implemented all the more basically and cost a few. This method should not use for power factor redress since it is satisfied equation (7).

I. REFERENCES

[1] L.R.Limongi, D.Roju, R.Bojoi, A.Tenconi Politenico di Torino, "Analysis of active power filters operating with unbalanced loads", *IEEE Transactions on Power electronics*, , september 2009.

- [2] Pengpai Dang, Jurgen Petzoldt, "A new control scheme of the three-phase four wire PWM converter under unbalanced and distorted input conditions", 14th international power electronics and motion control conference, EPE-PEMC 2010.
- [3] R. Teodorescu, F. Blaabjerg, M. Liserre and P.C. Loh, "Proportional-resonant controllers and filters for grid-connected voltage-source converters", *IEEE Transactions on E proc-electr. Power Appl.*, Vol.153, No.5, September 2006.
- [4] Bhim Singh, Kamal Al-Haddad, Senior Member, IEEE, and Ambrish Chandra, Member, IEEE, "A review of active filters for power quality improvement", *IEEE transactions on Industrial electronics*, Vol. 46, No.5, October 1999.
- [5] Christian Lascu, Lucian Asiminoaei, Member, IEEE, Ion Boldea, Fellow, IEEE, and Frede Blaabjerg, Fellow, IEEE, "High performane current controller for selective harmonic compensation in active power filters", *IEEE Transactions on Power electronics*, Vol.22, No.5, September 2007.
- [6] S. Bhattacharya, T.M. Frank, D.M. Divan, and B. Banerjee, "Active filter system implementation", *IEEE Transactions on Industry Applications* , Vol. 4, pp. 47-63, September/October 1998.
- [7] Liserre, M., Blaabjerg, F., and Hansen, S.: 'Design and control of an LCL-filter based active rectifier', *IEEE Trans. Ind. Appl.*, 2001, 38, pp. 299-307
- [8] H. Akagi, E.H. Atanabe, M. Aredes, "Instantaneous power theory and applications to power conditioning," *IEEE Press on Power Engineering*, A John Wiley & Sons, Inc., Publications
- [9] J.W.G.Huang, P.W.Lehn, and M.Winkelkemper, "Design of an optimal stationary frame controllers for grid connected AC-DC converters", in *IEEE industry Electron. Conf.*, Nov 2006, pp.167-172.
- [10] Narayana Divakar.R.V.L., " Realization of Current Control Strategies of Shunt Active Power Filter Operating With Unbalanced Loads", M.Tech thesis, 2014, NIT Rourkrla.

