



ANALYSIS OF CONCRETE FILLED DOUBLE SKIN STEEL TUBE (CFDST) COLUMN WITH FRP WRAPPING

¹Ashwathi M S, ²Margaret Abraham,

¹M.Tech Student, Civil Engineering Department, Vimal Jyothi Engineering College, Chemperi. ,

² Assistant Professor, Civil Engineering Department , Vimal Jyothi Engineering College, Chemperi.

Abstract: In this study modelling and analysis of Concrete filled double skin steel tube column is presented. CFDST consists of two steel layers embedding a concrete layer in between. CFDST have many advantages such as high strength, high bending stiffness, good seismic and fire performance. But the columns were proven to have certain shortcomings such as ageing of structures, corrosion of steel tubes. Therefore, the implementation of strengthening techniques with the new material is essential to eliminate this problem. In order to strengthen the CFDST column FRP wrapping is introduced in this study. The study and comparison of confinement effect under eccentric loading on varying different parameters of FRP was carried out. CFDST columns wrapped with FRP are modelled and analyzed using Finite element software ANSYS Workbench 16.1. From the analysis results it is found that the load capacity can be increased with the introduction of FRP confinement.

Keywords: CFDST, FRP, ANSYS

INTRODUCTION

CFDST column is a composite member, which consists of inner and outer steel skins with the annulus between the skins filled with concrete. From structural point of view, this form of column has higher strength (uni-axial, flexural and torsion). By replacing the central concrete with a steel tube of much smaller cross section area, the strength-to-weight ratio of the columns is improved significantly. Furthermore, the inner tube expands laterally during compression and hence increases the confining pressure provided to the concrete. Thus, the initial confining pressure builds up more rapidly than that in CFST columns that enhances the elastic strength and stiffness. From environmental point of view, CFDST column uses less concrete, which creates a more sustainable environment by reducing the embodied energy levels of the column. From cost effectiveness point of view, the tubes act as both the longitudinal reinforcement and formwork that save the construction cost and cycle. There are different possibilities to build CFDST columns combining tubes with different shapes (circular, square, rectangular). However, in general, those formed by circular columns have proved to be the most efficient in bearing the same ultimate load that column with the same steel cross-section area of other types. The cavity inside the inner tube provides a dry atmosphere for possible catering of facilities or utilities like power cables, telecommunication lines and drainage pipes. This form of construction is particularly useful for maritime structures, in which the subsea facilities can be accommodated in the dry atmosphere. In recent years, many steel and CFDST structures have been found to be suffering from a variety of deteriorations, including cracking, yielding and large deformation. These deteriorations are caused by a variety of factors, including fire, ageing, environmental degradation and corrosion. There are several strengthening or rehabilitation techniques that can be applied to enhance performance, including section enlargement, external bonding using steel plates and fibers, among others. Fiber Reinforced Polymer (FRP) composites can be used for rehabilitation. One of the main forces driving the development of external strengthening methods that uses the FRP composite is that they enable deteriorated members to be upgraded without significantly altering the appearance of the member. In addition, FRP composites are light weight, durable, and resistant to corrosion, and have high tensile strength, stiffness and fatigue strength. The work is limited to modelling and analysis of columns using ANSYS. This project work is restricted to long column under eccentric loading only. The work is focused only on circular composite columns. In this investigation length of concrete columns is restricted to 3000mm and the support condition is pinned. Researches were carried out in order to ensure mechanical stability of CFDST columns under axial loads using FRP wrapping, no much investigations were made to study the variation in deformation by varying the parameters of FRP wrapping. The objectives this research is to study the confinement effect under eccentric loading on :

- Varying material CFRP/GFRP
- Continuous, discontinuous and angular wrapping under different length.
- Discontinuous wrapping in angular alignment under different length and thickness

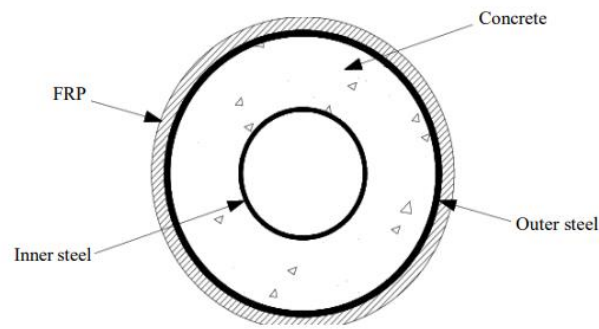

Fig.1.1 CFDST column with FRP wrapping

I. LITERATURE REVIEW

Aamir Hassan and Ms.S.Sivakamasundari (2014) conducted a “Study on Structural Strength and Behavior of Concrete Filled Double Skin Columns”. Column is a major axial load transferring Member in most of the structures. According to the revised seismic codes columns should have better flexural strength in addition to the axial load carrying capacity. It was a major concern in construction industry in previous few years to increase the column strength. Concrete-Filled Double Skin Tubes (CFDST) is one of the latest innovations in Structural engineering. The CFDST members were first designed for vessels to resist extreme external pressure but due to its various advantages, it has got strong demand and strong potential for using it in bridges, flyovers and high rise buildings. In this study CFDST was analyzed using ABAQUS/CAE 6.11-1 and experimentally tested for stress strain and axial shortening.

Anna Skaria and Mariamol Kuriakose (2018) Studied about "Numerical Study on Axial Behavior of Concrete Filled Double Skin Steel Tubular (CFDST) Column with cross helical FRP wrappings." The load carrying capacity of fiber reinforced CFDST columns under axial load was found. The FRP is provided as cross helical strips circumscribed about the column. The parameters used in this study is change in fiber material (glass fiber reinforced polymer (GFRP), carbon fiber reinforced polymer (CFRP), basalt fiber reinforced polymer (BFRP), aramid fiber reinforced polymer (AFRP), change in helix angle (40°, 45°, 50°, 60°) and change in thickness (0.3mm, 0.6 mm, 0.9 mm). The nonlinear static analysis is carried out to determine the deformation, axial stress and strain of different models. About 6 numbers of CFDST columns were modeled. Results was that the load bearing capacity of columns with FRP wrapping with helix angle 45° was greater than the specimen without wrappings, this is mainly due to the proper confinement. The load carrying capacity increases up to 45° and then decreases. The application of GFRP strips increases axial load carrying of CFDST columns compared with BFRP, CFRP and AFRP. With the increase in the thickness the ultimate load carrying capacity also increases.

Jun-Jie Zeng et.al (2021) Studied about “Axial compressive behavior of FRP-concrete-steel double skin tubular columns with a rib-stiffened Q690 steel tube and ultra-high strength concrete”. Fiber-reinforced polymer (FRP) concrete-steel double skin tubular columns (DSTCs), which possess an outer FRP tube, an inner steel tube and sandwiched concrete between both tubes, are a kind of hybrid column with a particular merit of lightweight. It was expected that using high-strength materials (i.e., ultra-high strength concrete (UHSC) and high-strength steel (HSS) tubes) in DSTCs magnifies the merit of DSTCs. This paper presented an experimental study on axial compression behavior of DSTCs with ultra-high strength concrete and a rib-stiffened Q690 steel tube. The rib-stiffened steel tubes, which are less susceptible to local buckling compared with those without stiffeners, were used in the present study. The parameters including the quantity of stiffeners, the length of stiffeners, the FRP tube thickness, the steel tube diameter and the concrete strength were carefully designed and investigated through the experimental study. The test results demonstrate that DSTCs with UHSC and HSS tubes exhibit a ductile behavior. Additionally, the stiffeners are beneficial in enhancing the performance of DSTCs.

Lin-Hai Han et.al (2011) studied about “Tests on stub stainless steel–concrete–carbon steel double skin tubular (DST) columns”. A new type of composite member, a stainless steel–concrete–carbon steel double-skin tubular (DST) column, was introduced in this paper. This composite member was expected to combine the advantages of all three types of materials, and have additional advantages of aesthetics and resistance to corrosion that outer stainless steel offers. A series of tests were performed to investigate the performance of the composite column, and a total of 80 specimens were tested. The main parameters of the tests are the sectional type (circular, square, round-end rectangular and elliptical), the column type (straight, inclined and tapered), and the hollow ratio of the composite section (from 0.5 to 0.75). The results shows that all types of

columns behaved in a ductile manner, and the mechanical behavior is similar to those columns with double carbon steel tubes. A simplified model for the prediction of the stainless steel–concrete–carbon steel double-skin tubular (DST) columns cross sectional strengths was suggested as well.

Mohammad Zakir and Fayaz A. Sofi (2022) Studied about “Experimental and nonlinear FE simulation-based compressive behavior of stiffened FRP-concrete-steel double-skin tubular columns with square outer and circular inner tubes” Double-skin tubular columns (DSTCs) confined with outer fiber-reinforced polymer (FRP) and stiffened inner steel tube shows more promising axial stress-strain behavior for sandwiched concrete than its traditional unstiffened form. This study experimentally investigated the compressive behavior of stub-type stiffened DSTCs consisting of square-shaped, filament-wound outer glass FRP and circular inner steel tubes. The first-ever finite element (FE) simulations were performed to validate the test results of 12 square-circle (SC) shaped DSTCs (about 2 to 6% average errors at critical elastic, peak and ultimate axial loads) for various parametric variation in stiffener properties on inner steel tube, such as quantity, configuration for the similar total stiffener area, effective placement, and stiffener cross-section dimensions and shape. An analysis-oriented axial stress-strain model was proposed for confined concrete in stiffened DSTCs of SC shape using the experimental and FE-based results. Finally, this study proposed a simplified axial loadbearing equation for estimating the peak axial load capacity of stiffened DSTCs

T. Yu et.al (2012) studied about “Behavior of hybrid FRP-concrete-steel double-skin tubular columns subjected to cyclic axial compression”. Hybrid FRP-concrete-steel double-skin tubular columns (hybrid DSTCs) are a new form of hybrid columns which consists of a layer of concrete sandwiched between an inner steel tube and an outer FRP tube. While a large amount of research has been conducted on the monotonic behavior of this novel form of columns, only a limited amount of work has been conducted on their behavior under cyclic loading. This paper presented the first ever study on the behavior of circular hybrid DSTCs under cyclic axial compression. Results from a series of stub column tests, where the hybrid DSTCs were subjected to cyclic axial compression, were first presented and discussed. The test results shows that hybrid DSTCs are very ductile under cyclic axial compression, with the envelope axial load-strain curve being almost the same as the axial load-strain curve of a corresponding DSTC under monotonic compression. It was also shown that repeated unloading/reloading cycles have a cumulative effect on the permanent strain and the stress deterioration of the confined concrete in hybrid DSTCs. The experimental stress–strain curves of the confined concrete in hybrid DSTCs were then compared with predictions from two existing models: (1) a monotonic stress–strain model for the confined concrete in hybrid DSTCs; and (2) a cyclic stress– strain model for the concrete in FRP-confined solid columns. The comparison suggests that the combined use of the two models can give reasonably accurate predictions of the test results.

I. METHODOLOGY

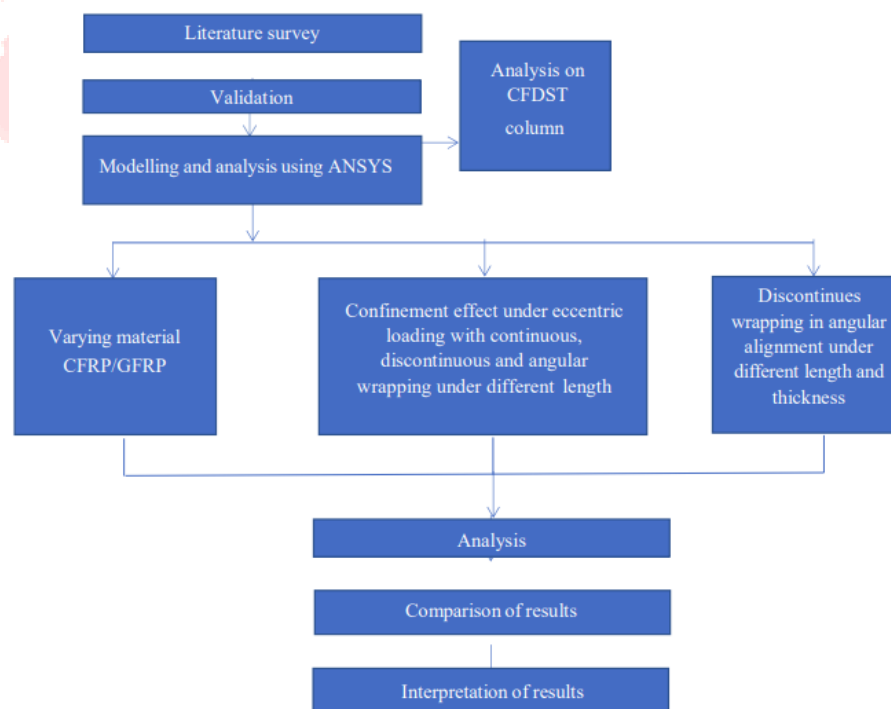

SOFTWARE USED

The types of software which are mainly used for the study include;

Analyzing System (ANSYS) :- ANSYS is a commercial FEM package having the capabilities ranging from a simple, linear, static analysis to a complex, nonlinear, transient dynamic analysis. ANSYS is a general purpose finite element modelling package for numerically solving a wide variety of mechanical problems. These problems include static structural analysis (both linear and nonlinear), heat transfer and fluid problems, as well as acoustics and electromagnetic problems. ANSYS offers an easy and flexible platform for performing finite element analysis of structures or models with great accuracy. ANSYS consists of working platforms called APDL and workbench among which workbench provides more automated options for the analysis operations.

Microsoft Office Excel :- Excel is the spreadsheet software that allows you to store, organize and text data. In the present study after analysis, the results were drawn and graphs were plotted using chart tools option.

IV. VALIDATION

The validation was done using the paper “Behavior of slender concrete-filled dual steel tubular columns subjected to eccentric loads”. Finite element analysis was conducted on CFDST column and the mid deflection caused due to axial load was compared with the journal. The CFDST column used for validation was having a length of 3000mm and an eccentricity of 50mm. Dimensions of CFDST Column is tabulated in table 4.1

Table 4.1 Dimensions of CFDST column.

Length of column	3000mm
Eccentricity	50mm
Diameter(outer tube)	219.1mm
Diameter(inner tube)	108mm
Thickness(outer tube)	3mm
Thickness(inner tube)	2mm

Properties of material used:

Concrete	Elastic modulus	30058 MPa
	Poisson's ratio	0.12
	Compressive Strength	40.43 MPa
Steel	Density	7850 kg/m ³
	Young's Modulus	200 GPa
	Poisson's ratio	0.3

GEOMETRY

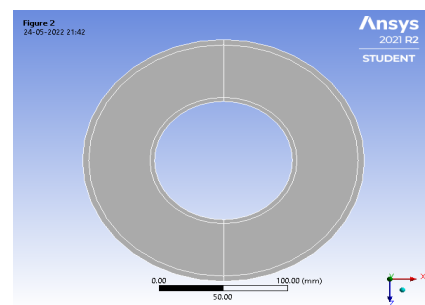
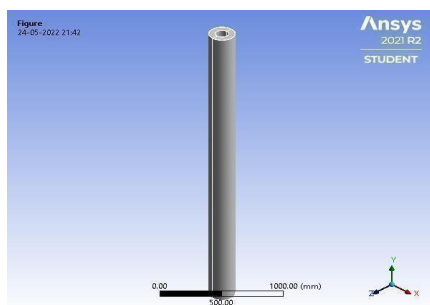
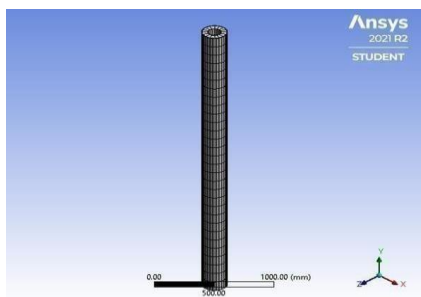

Fig.4.1 Geometry of the model

FINITE ELEMENT MODEL

The element type used here is solid 185. There exist frictional connection between the inner tube to concrete and also between outer tube to concrete. Element size used for meshing is 25mm and element shape used is hexahedron. Specimens were tested under pinned-pinned (P-P) end condition and load of 25mm was applied with an eccentricity of 50mm.



(a) Meshed view of model

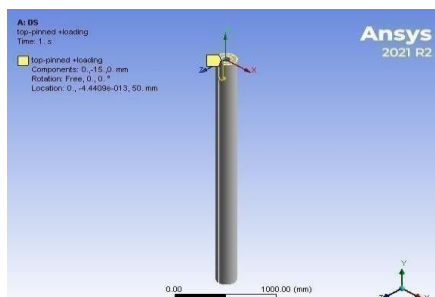

(b) CFDST column with boundary condition

RESULT AND DISCUSSION

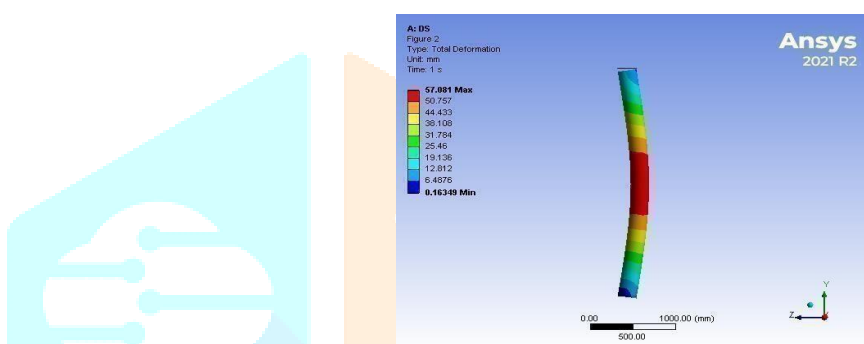

Fig.4.3 Deformed shape of the model

Table 4.4 Load deformation from FEA

Axial load (KN)	Deflection(mm)
0	0
279.56	3.6334
540.29	7.3363
739.78	11.264
851.32	15.456
929.55	19.661
977.34	23.824
939.46	27.97
885.75	32.159
825.56	36.432
776.35	40.787
737.83	45.04
706.72	49.207
690.19	53.177
679.03	57.071
673.01	61.116
669.38	65.017
665.78	68.952
661.42	72.56
656.18	75.907
648.07	78.945

The load for maximum deflection 23.824mm is obtained as 977.34.

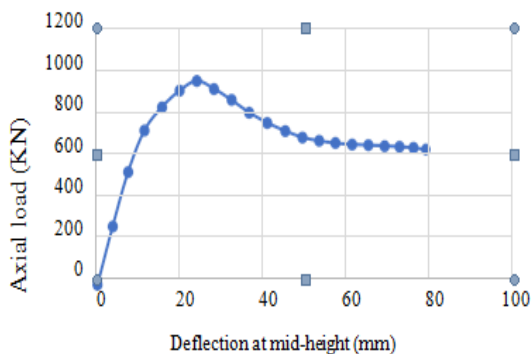

Fig.4.4 load v/s deformation behavior journal

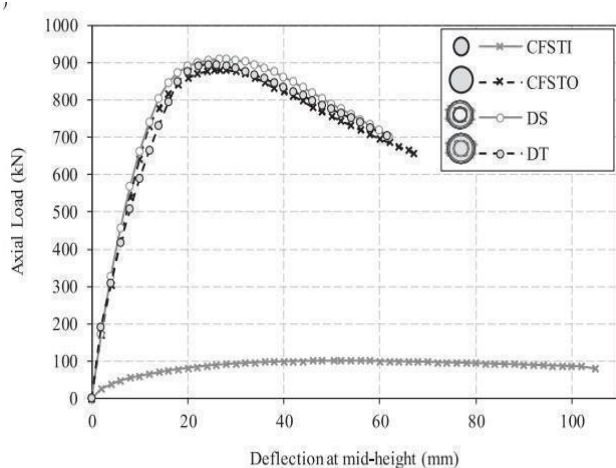

Fig.4.5 Load vs Deformation from

Table 4.5 Validation results

DS		
	MAXIMUM AXIAL LOAD(KN)	MID DEFLECTION (mm)
JOURNAL	909.5	26
FEA	977.34	23.82
PERCENTAGE ERROR	-7.19	8.75

From table 4.5 it can be seen that the percentage error obtained from the validation is within the permissible limit.

V. MODELLING AND ANALYSIS

The dimension details and material properties of the CFDST columns used for study are in Table 5.1 and 5.2 respectively. IS1161:1998 (STEEL TUBES FOR STRUCTURAL PURPOSES – SPECIFICATION) was considered for the study. Dimensions of CFDST Column.

Table 5.1 Dimension details of column

Diameter(Outer tube)	219.1mm
Thickness(outer tube)	4.8mm
Diameter(Inner tube)	114.3mm
Thickness (Inner tube)	3.6mm
Eccentricity	50mm
FRP thickness	1.27mm

Properties of material used:

Table 5.2 Properties of the materials

Concrete	Grade of Concrete	40
	Elastic modulus	31622.77MPa
	Poisson's ratio	0.12
	Compressive Strength	40 MPa
	Density	2400kg/m3
Steel	Density	7850kg/m3
	Young's Modulus	200GPa
	Poisson's ratio	0.3
	Yield Strength	345 MPa

Modelling

The model of the CFDST column specimen considered in this study is mentioned below. This model is the base model and to this the different parameters are compared.

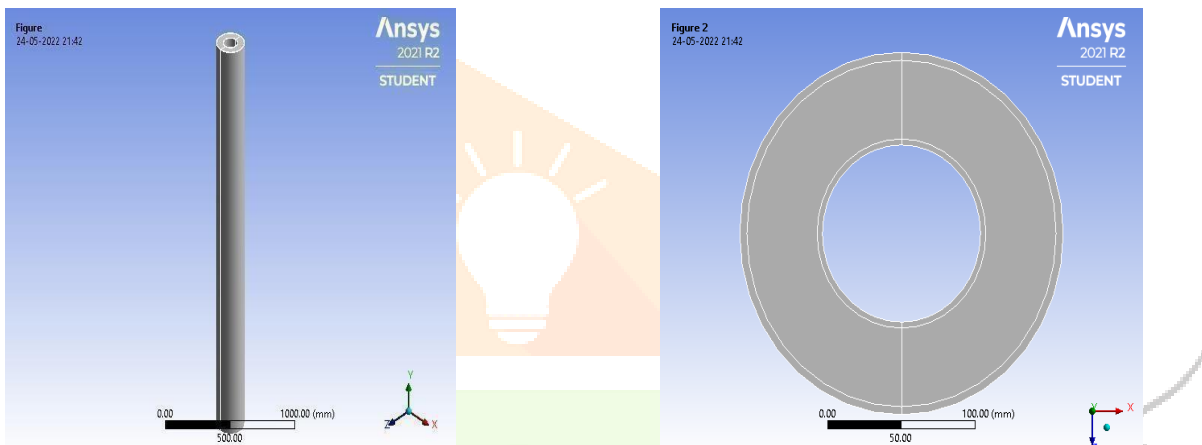

(b)

Fig.5.1 Modelling of CFDST column base model and to this the different parameters are compared. (a) Model

(b) Cross section of the model

Meshing and Loading and Analysis

Concrete Filled Double Skin column is modelled using hexahedron mesh. Load is applied as displacement of 15 mm according to displacement convergence method. Analysis is carried out to study the performance of Concrete Filled Double Skin Columns. Nonlinear static structural analysis is carried out in ANSYS software.

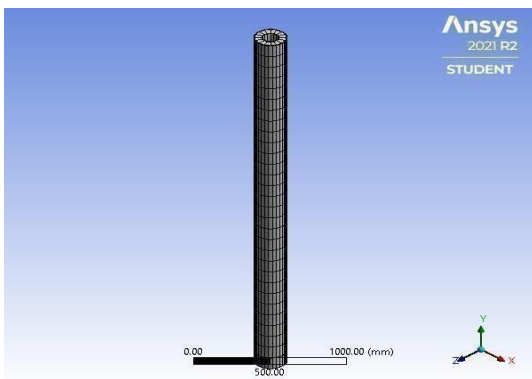

Fig.5.2 Meshing of the model.

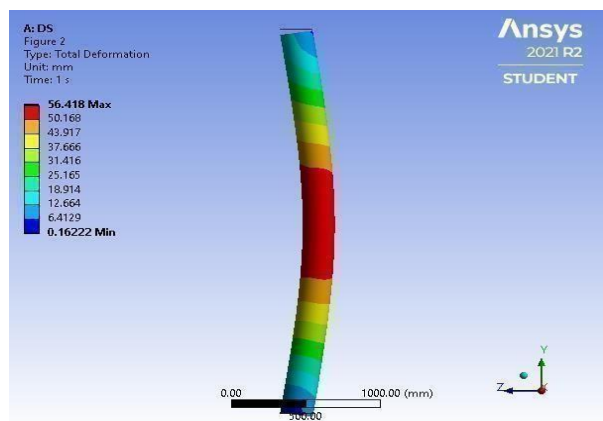

Fig.5.3. Total deformation of the CFDST column

VI. RESULTS AND DISCUSSIONS

The CFDST columns were analyzed using finite element analysis in ANSYS workbench. We can obtain the required parameters as solution by adding the options under different categories like deformations, stress, etc. A wide range of solution options and parameters are available. Here only load and deformations are discussed. The load-deformation relation is used for comparison. The result obtained from the Nonlinear static structural analysis of CFDST is found. The load deformation curve is taken and is shown in table 6.1.

Table.6.1 Load Deformation of base model.

DEFORMATION(mm)	LOAD (KN)	LOAD (N)
0.00	0.00	0.00
4.53	319.63	319630.00
9.30	619.38	619380.00
14.45	841.23	841230.00
20.31	945.27	945270.00
26.00	1007.60	1007600.00
31.94	1022.70	1022700.00
36.76	984.05	984050.00
41.59	965.40	965400.00
47.82	957.41	957410.00
53.96	924.69	924690.00
57.08	909.45	909450.00

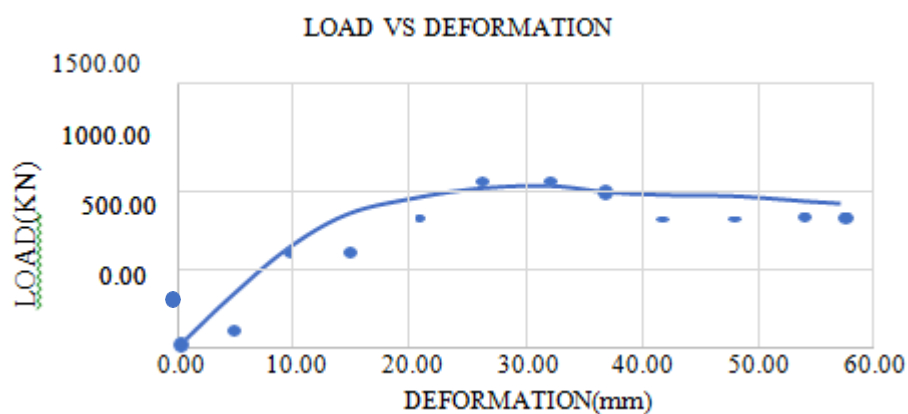

Fig.6.1 Load deformation curve

From the above mentioned table and corresponding graph we can conclude that the maximum load that the CFDST column can carry without any confinement is 1022.5KN under the deformation of 31.94mm.

STUDY OF CONFINEMENT EFFECT UNDER ECCENTRIC LOADING WITH VARYING MATERIALS CFRP/GFRP

The CFDST columns were modelled in ANSYS software with varying material of FRP under varying length and thickness. A total of seven models were modelled as shown below

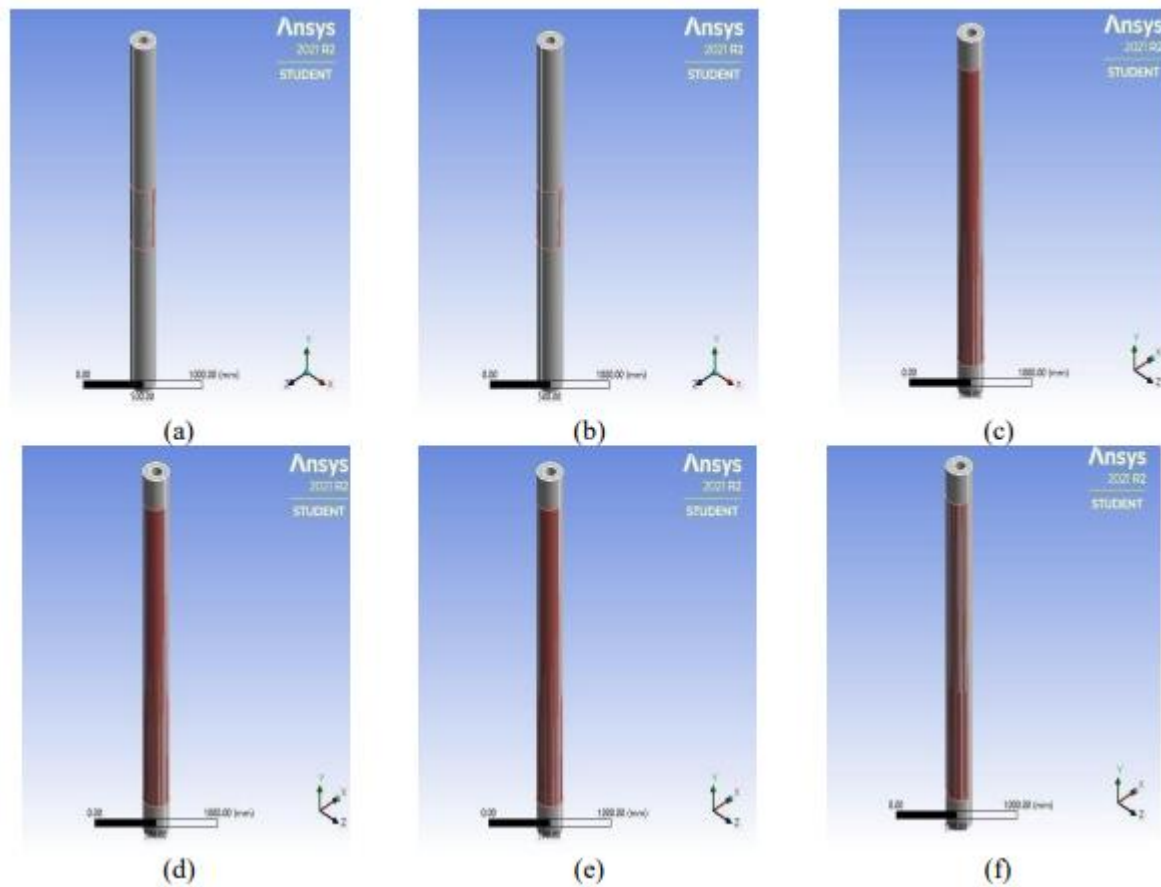

Fig 6.2 Modelling of CFDST columns by varying materials (CFRP/GFRP) by varying thickness of FRP and by varying the length of FRP (a) Model with continuous GFRP confinement of 500mm (b) Model with continuous CFRP confinement of 500mm (c) Model with continuous GFRP confinement of 2500mm (d) Model with continuous CFRP confinement of 2500mm (e) Model with continuous 2 layer GFRP confinement of 2500mm (f) Model with continuous 2 layer CFRP confinement of 2500mm. CFDST column is modelled using hexahedron mesh. Load is applied as displacement of 15 mm according to displacement convergence method. Analysis is carried out to study the confinement effect under eccentric loading on Concrete Filled Double Skin Columns.

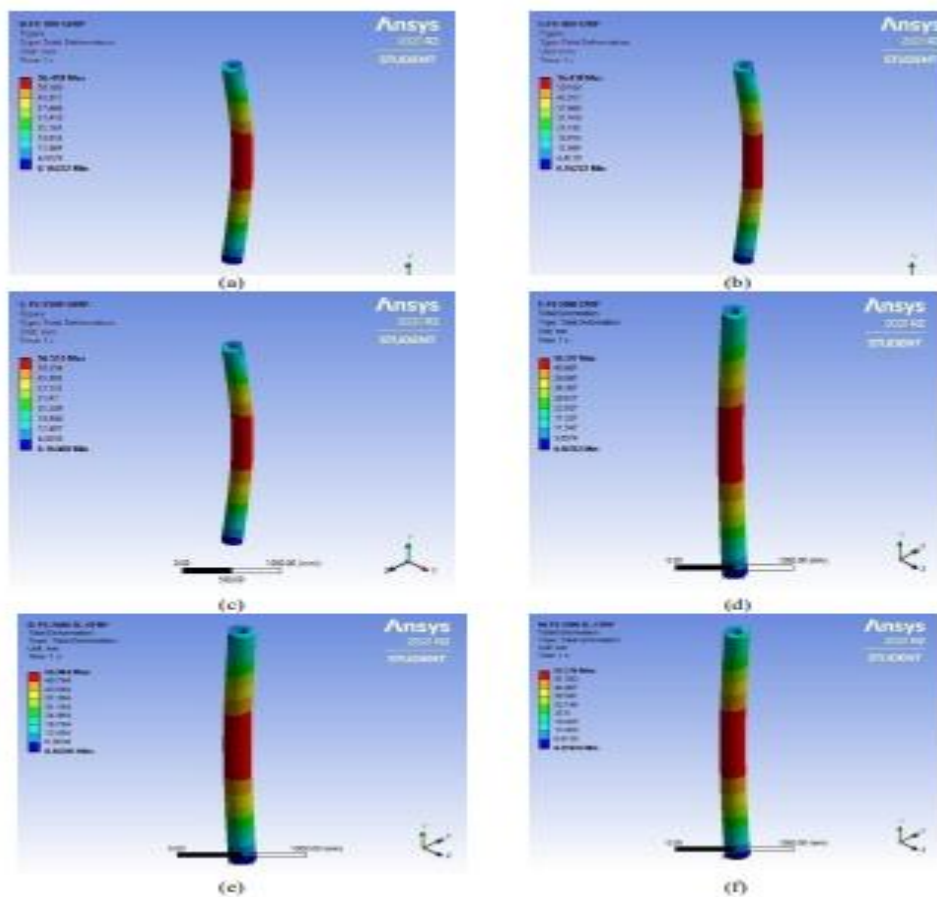

Fig 6.3 (a) Deformation of CFDST column wrapped with 500mm GFRP (b) Deformation of CFDST column wrapped with 500mm CFRP (c) Deformation of CFDST Column wrapped with 2500mm GFRP(d) Deformation of CFDST Column wrapped with 2500mm CFRP (e) Deformation of CFDST Column wrapped with 2500mm 2 layer GFRP (f) Deformation of CFDST Column wrapped with 2500mm 2 layer CFRP.

The load and deflection comparison of the CFDST column with the proposed models by introducing FRP, by varying material of FRP (CFRP/GFRP) along with variation in thickness and length of FRP is presented in table 6.2.

Table 6.2 Load-deformation comparison

MODEL	ULTIMATE DEFORMATION(mm)	LOAD(KN)	% DIFFERNCEIN LOAD
DS	31.94	1022.70	-
FS-500-GFRP	37.62	1044.5	2.13
FS-500-CFRP	36.66	1054.8	3.14
FS-2500-GFRP	35.79	1055.1	3.17
FS-2500-CFRP	39.59	1196.6	17.00
FS-2500-2L-GFRP	31.19	1056.2	3.28
FS-2500-2L-CFRP	33.593	1315	28.58

Fig.6.4 shows he comparison of load deformation curve of CFDST column with the proposed models by introducing FRP, by varying material of FRP (CFRP/GFRP) along with variation in thickness and length of FRP.

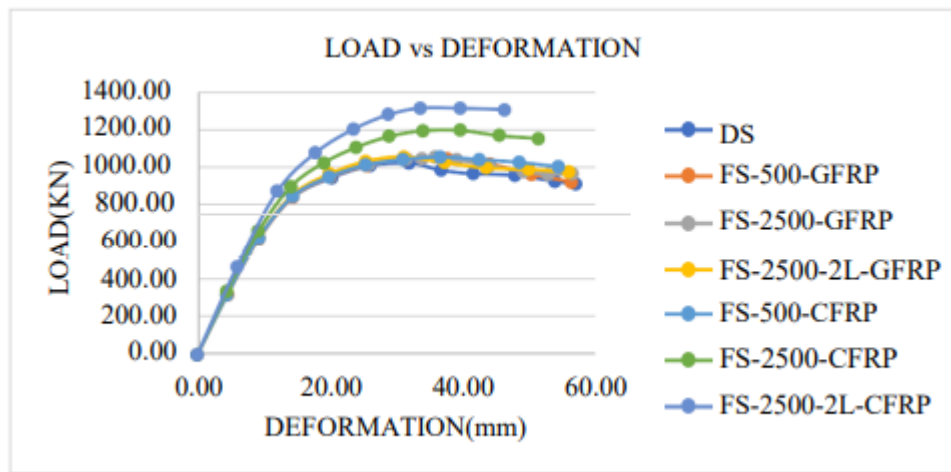

Fig.6.4 Comparison of load deformation curves

The figure below shows the load comparison of CFRP and GFRP models.

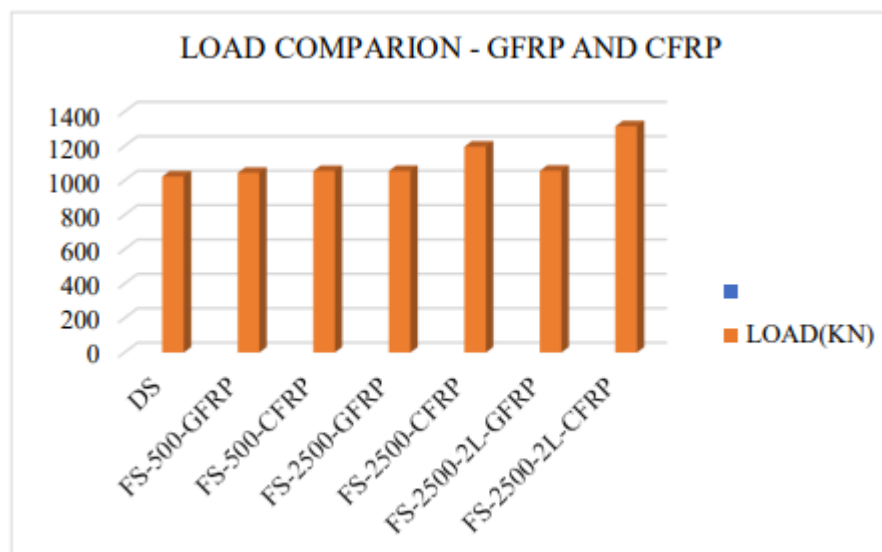
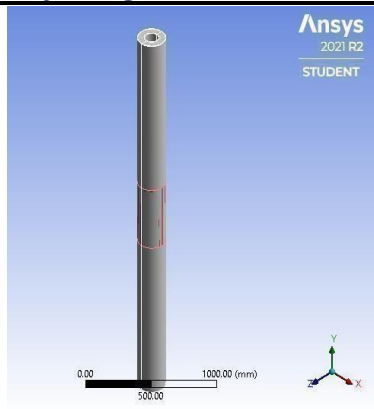

Fig.6.5 Load comparison of GFRP and CFRP

On the study of comparing the performance of various materials, CFRP and GFRP it is observed that maximum of 3.14% and 2.13% increase in the load carrying capacity is observed from CFRP and GFRP 500mm confinement respectively. On the study of increase in the length of wrapping under CFRP and GFRP it is found that maximum of 17% increment is observed for the CFRP wrapped case when compared with GFRP wrapped case. On the result of comparing with the increase in layer of CFRP and GFRP, it is founded that the CFRP confinement gives 28.58% increase in the load carrying capacity than GFRP. Therefore we can conclude that CFRP confinement gives the better performance than the GFRP.

STUDY OF CONFINEMENT EFFECT UNDER ECCENTRIC LOADING WITH CONTINUOUS DISCONTINUOUS AND ANGULAR WRAPPING UNDER DIFFERENT LENGTH

The CFDST columns were modelled in ANSYS software with continuous, discontinuous and angular wrapping under different length and thickness. Load deformation study is carried out on the above mentioned models. A total of eight models were studied and compared. Specimens were tested under pinned-pinned end condition.



(a)



(b)

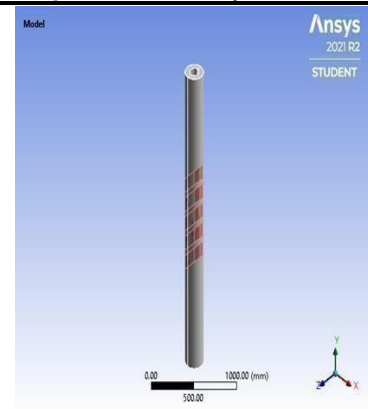

(c)

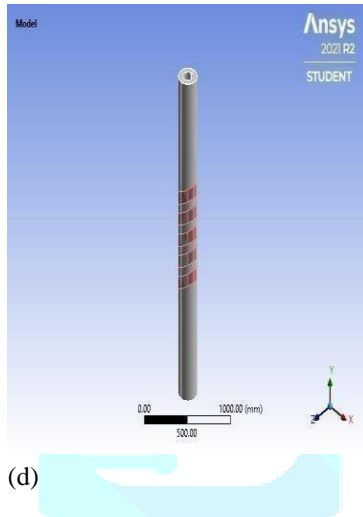

(d)

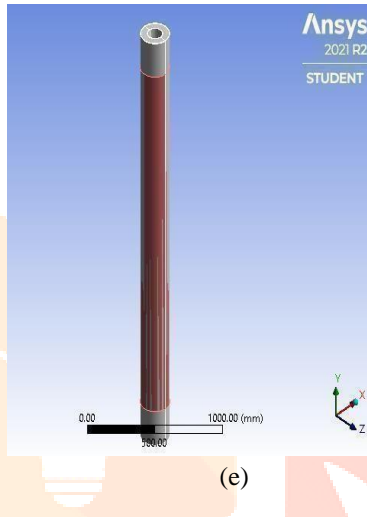

(e)

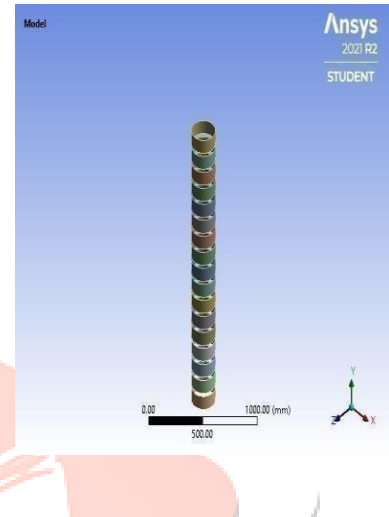

(f)

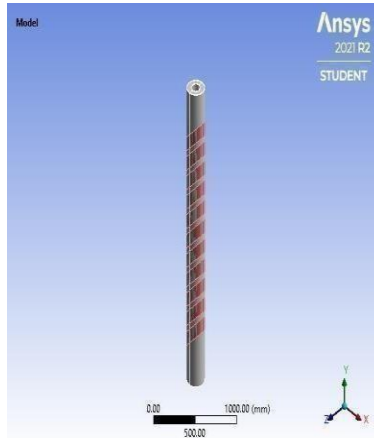

(g)

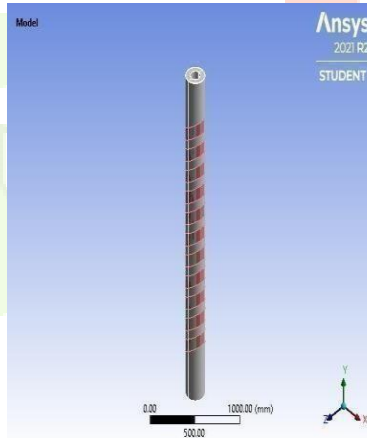

(h)

Fig.6.6 Modelling of CFDST column with continuous , discontinuous and angular wrapping under different length (a) model with a continuous CFRP confinement of 500mm (b) model with a discontinuous CFRP confinement of 500mm (c) model with discontinuous wrapping at 45 degree alignment of CFRP confinement at 500mm length (d) model with discontinuous wrapping at 30 degree alignment of CFRP confinement at 500mm length (e) model with a continuous CFRP confinement of 2500mm (f) model with a discontinuous CFRP confinement of 2500mm (g) model with discontinues wrapping at 45 degree alignment of CFRP confinement at 2500mm length (h) model with discontinuous wrapping at 30 degree alignment of CFRP confinement at 2500mm length.

Analysis is carried out to study and compare the confinement effect under eccentric loading with continuous, discontinuous and angular wrapping under different length. Nonlinear static structural analysis is carried out in ANSYS software. Deformation and load carrying capacity are studied and compared .The deformation diagrams are shown in Figure below.

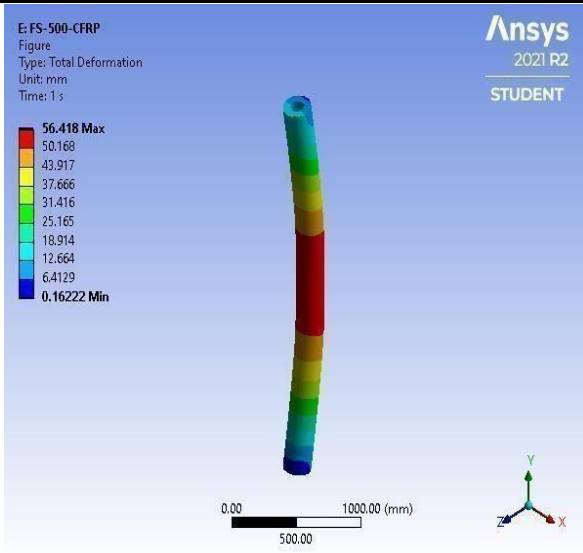

(a)

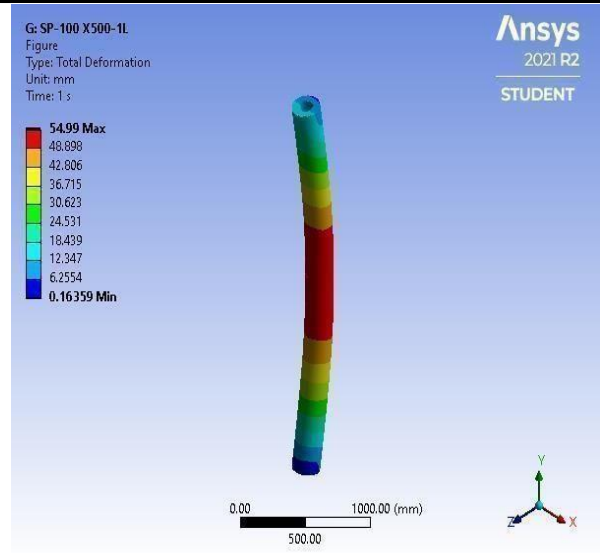

(b)

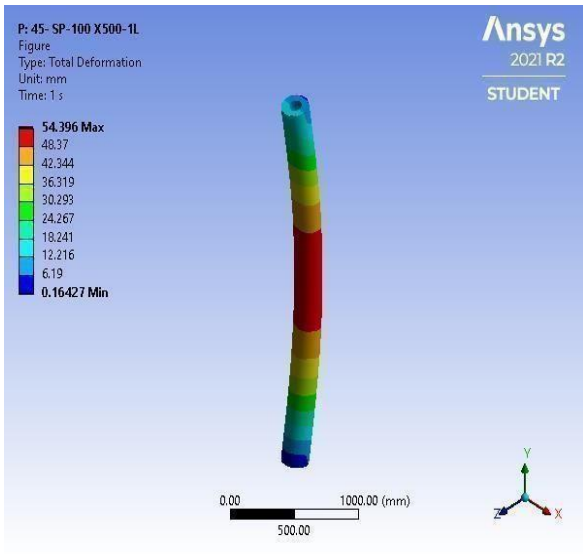

(c)

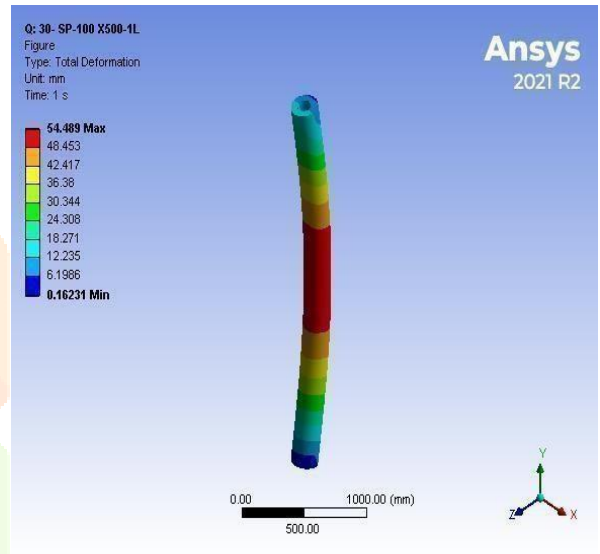

(d)

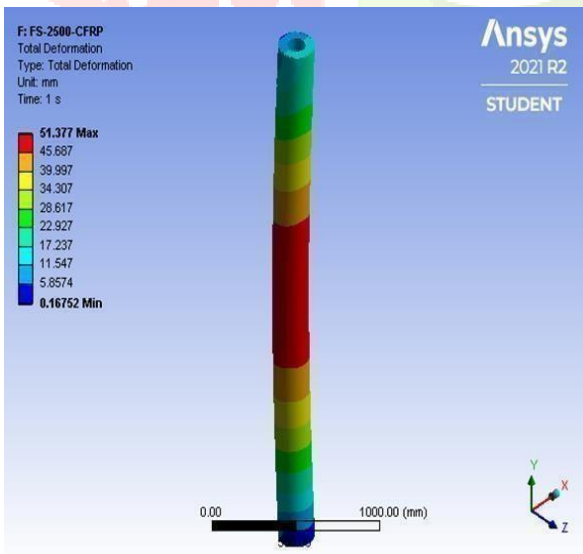

(e)

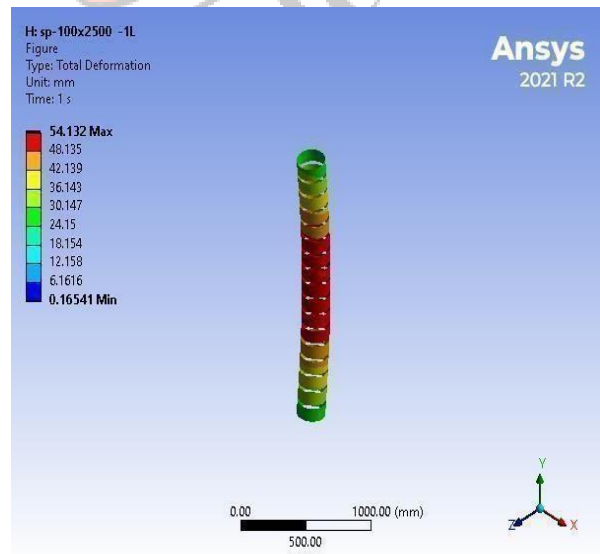

(f)

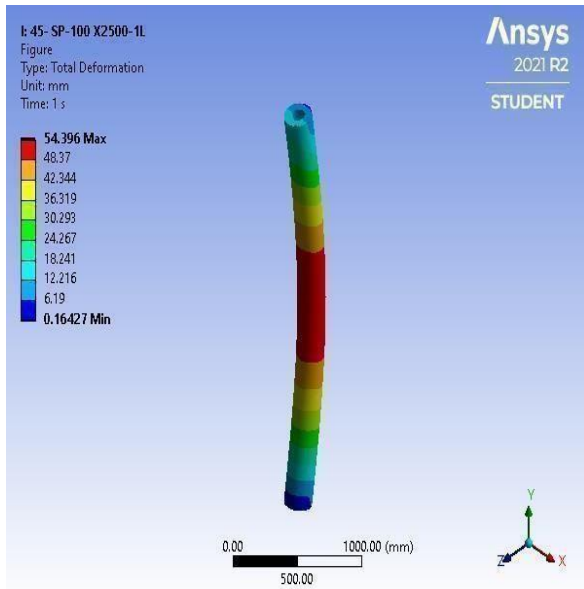

(g)

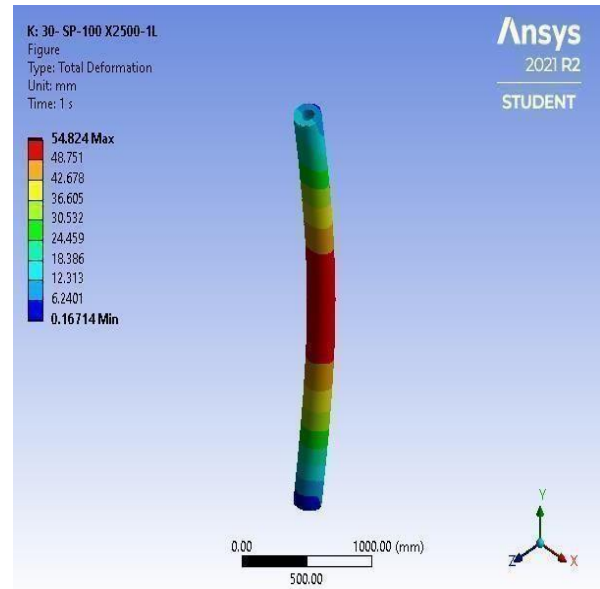

(h)

Fig.6.7 (a) Deformation of CFDST column wrapped with 500mm CFRP (b) Deformation of CFDST column wrapped at 30° inclination with discontinuous 2500mm CFRP (c) Deformation of CFDST column wrapped at 45° inclination with 500mm CFRP (d) Deformation of CFDST column wrapped at 30° inclination with discontinuous 500mm CFRP (e) Deformation of CFDST column wrapped with 2500mm CFRP (f) Deformation of CFDST column wrapped with discontinuous 500mm CFRP (g) Deformation of CFDST column wrapped at 45° inclination with discontinuous 2500mm CFRP (h) Deformation of CFDST column wrapped at 30° inclination with discontinuous 2500mm CFRP. The load and deflection comparison of the proposed models under eccentric loading with continuous wrapping under different length are shown in the table below. In table 6.1 the discontinuous 500mm CFRP confined models are compared with continuous 500mm CFRP confined model and in table 6.2 the discontinuous 2500mm CFRP confined models are compared with continuous 2500mm CFRP confined model.

Table 6.3 Comparison of load and ultimate deformation.

MODEL	ULTIMATE DEFORMATION(mm)	LOAD(KN)	%DECREASE
FS-500-CFRP	36.66	1054.8	-
0-SP-100 X500-1L	37.03	1050.2	0.44
45 -SP-100 X500-1L	36.73	1040.5	1.36
30-SP-100 X500-1L	36.623	1052.7	0.20

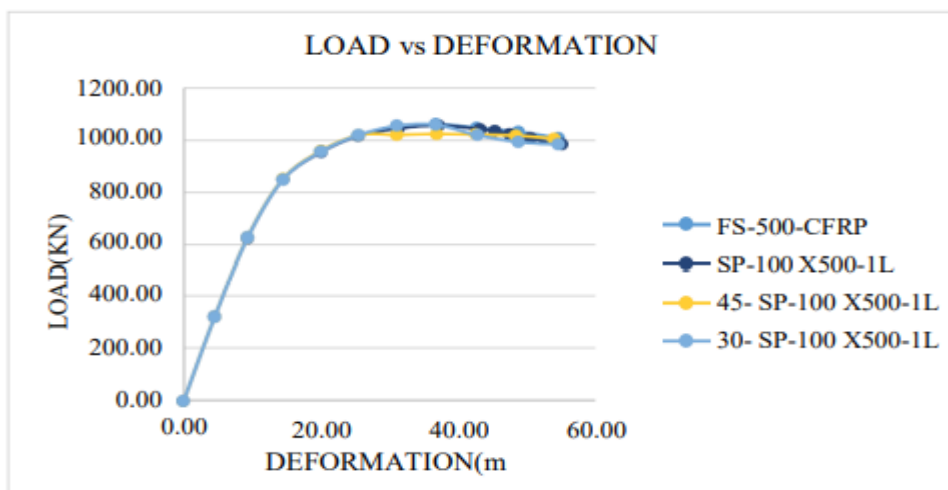

Fig.6.8 Comparison of load deformation curves

On carrying out the load deformation comparison of the proposed models under eccentric loading with continuous 500mm CFRP wrapped model it can be observed that 500mm CFRP wrapped model gives effective performance than the discontinuous ones. Only negligible difference in the load variation is observed.

Table 6.4 Comparison of load and ultimate deformation.

MODEL	ULTIMATE DEFORMATION(mm)	LOAD(KN)	% DECREASE
FS-2500-CFRP	39.59	1196.6	-
0-SP-100x2500-1L	36.15	1088.7	9.02
45- SP-100 X2500-1L	30.65	1061.1	11.32
30- SP-100 X2500-1L	36.45	1080.9	9.67

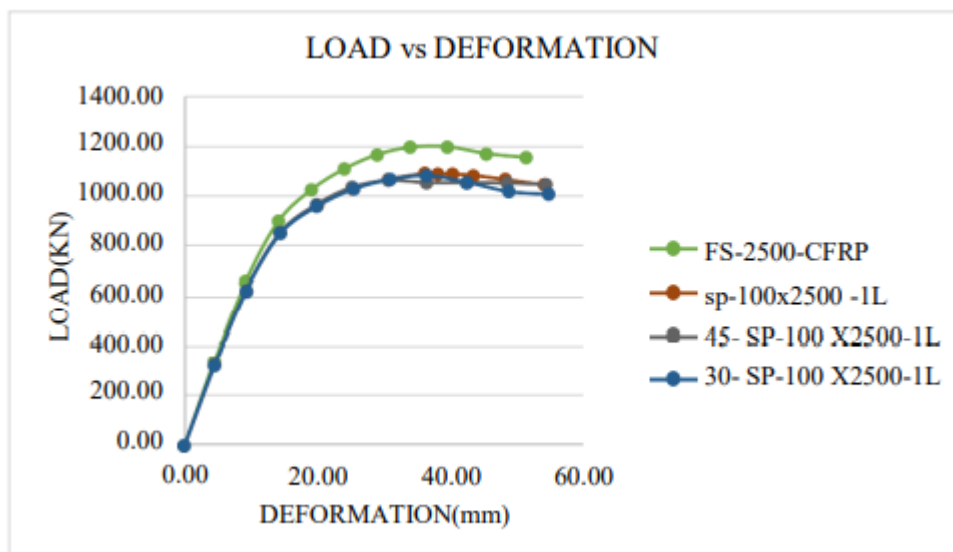

Fig.6.9 Comparison of load deformation curves

On carrying out the load deformation comparison of the proposed models under eccentric loading with continuous 2500mm CFRP wrapped model it can be observed that 2500mm CFRP wrapped model gives effective performance than the discontinuous ones.

STUDY OF CONFINEMENT EFFECT UNDER ECCENTRIC LOADING WITH DISCONTINUOUS WRAPPING IN ANGULAR ALLIGNMENT UNDER DIFFERENT LENGTH AND THICKNESS

The CFDST columns were modelled in ANSYS software with discontinuous wrapping in angular alignment under different lengths and thicknesses. A total of eleven models were studied and compared.



(a)

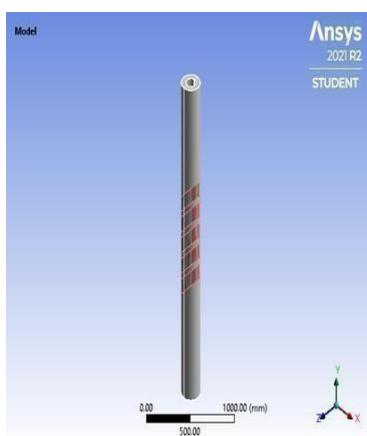

(b)



(c)

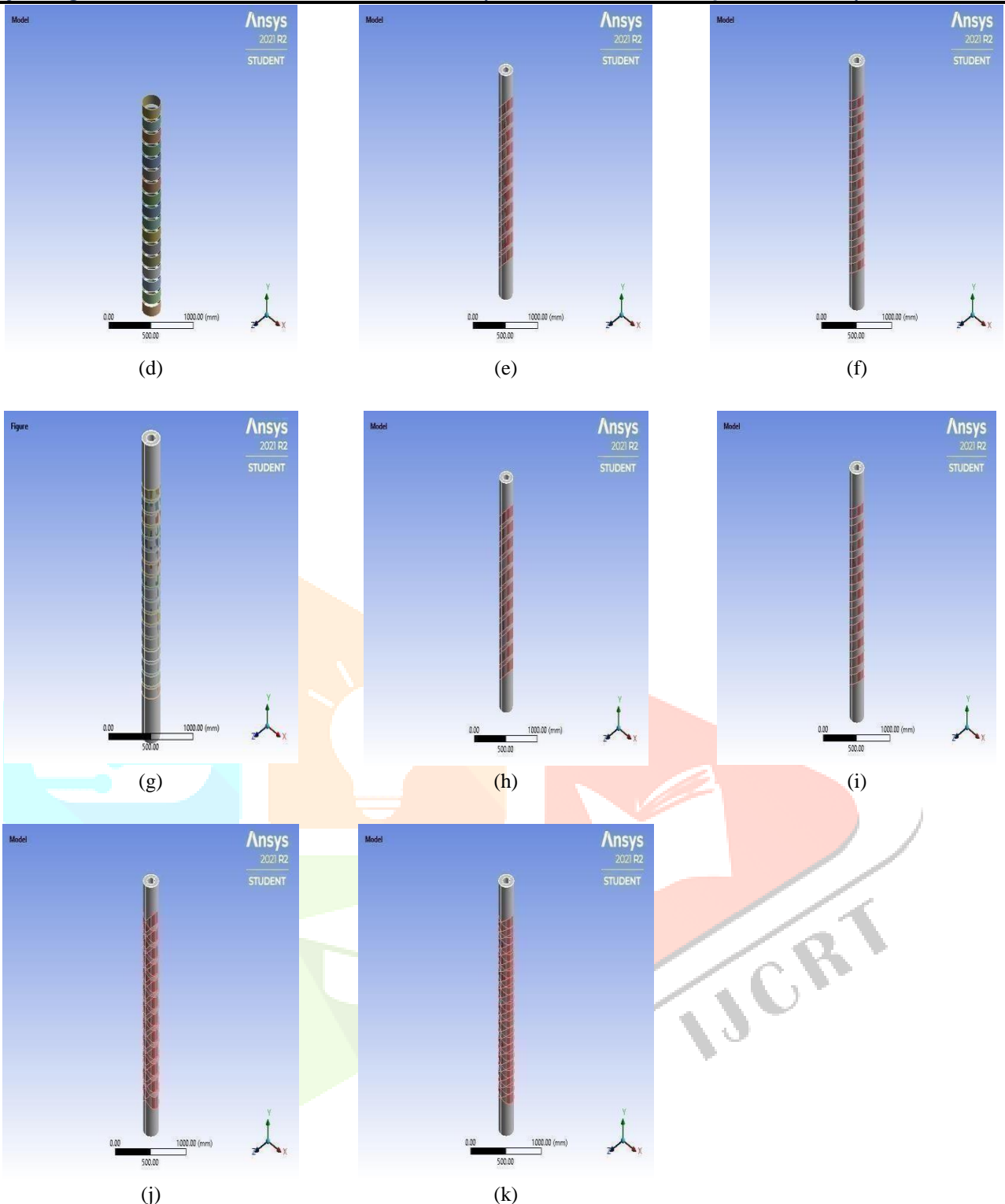
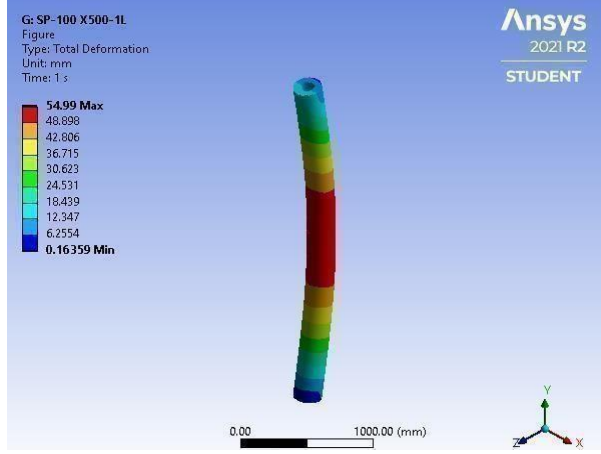
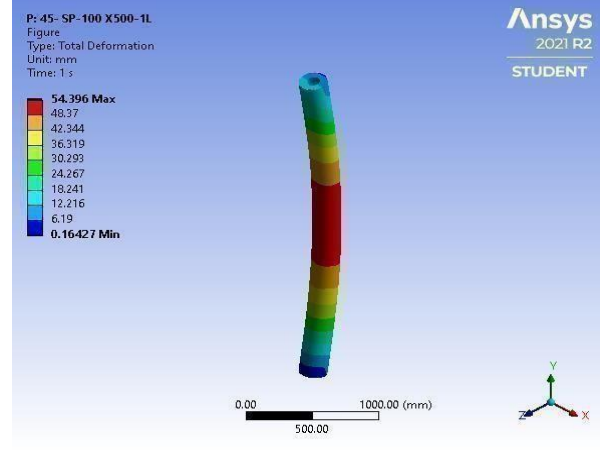

Fig.6.10 Modelling of CFDST column with discontinuous wrapping in angular alignment under different length and thickness. (a) model with 0 degree discontinuous 500mm CFRP confinement (b) model with a 30 degree discontinuous 500mm CFRP confinement (c) model with a 45 degree discontinuous 500mm CFRP confinement (d) Fourth model with 0 degree discontinuous 2500mm CFRP confinement (e) model with a 30 degree discontinuous 2500mm CFRP confinement (f) model with a 45 degree discontinuous 2500mm CFRP confinement (g) model with a 0 degree discontinuous 2 layer 2500mm CFRP confinement (h) model with a 30 degree discontinuous 2 layer 2500mm CFRP confinement (i) model with 45 degree discontinuous 2 layer 2500mm CFRP confinement (j) model with discontinuous 2500mm CFRP at -45 degree +45 degree inclination (k) model with discontinuous 2500mm CFRP at -30 degree 30 inclination.

Analysis is carried out to study and compare the confinement effect under eccentric loading with discontinues wrapping in angular alignment under different length and thickness. Nonlinear static structural analysis is carried out in ANSYS software. Deformation and load carrying capacity are studied and compared .The deformation diagrams are shown in Figure below.



(a)



(b)

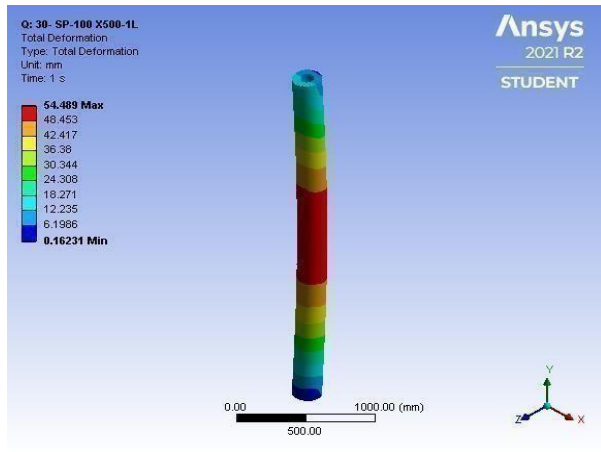

(c)

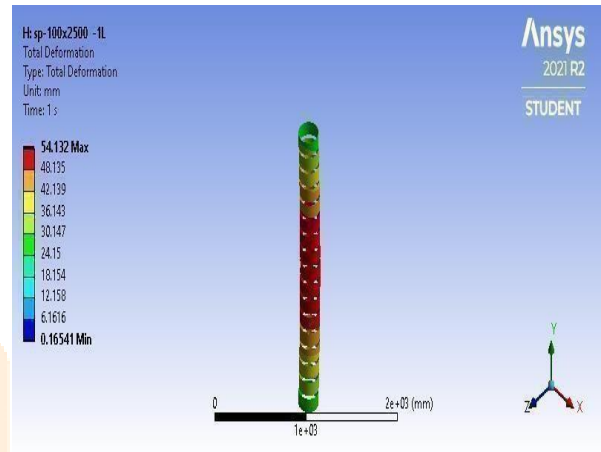

(d)

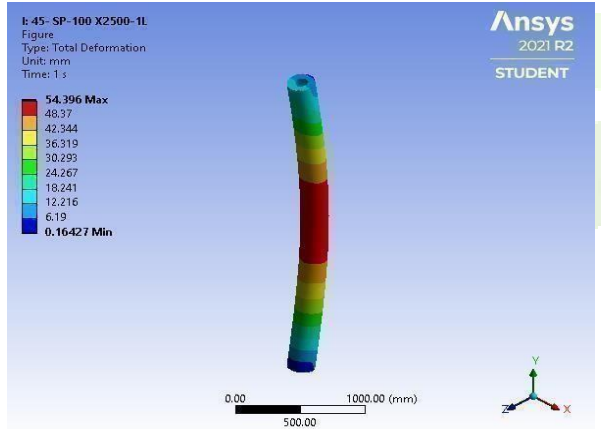

(e)

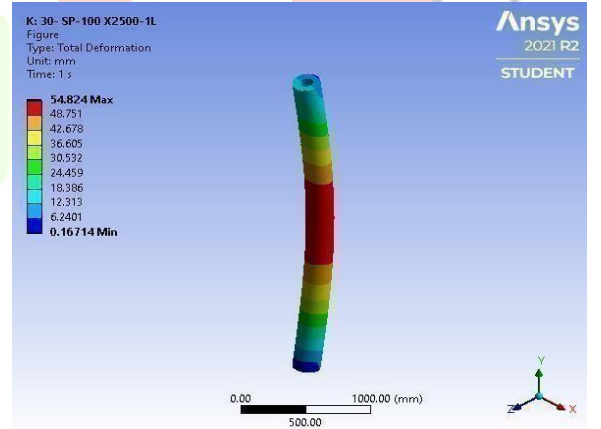

(f)

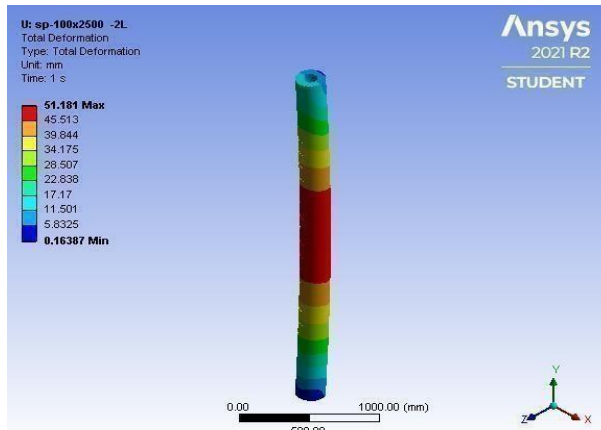

(g)

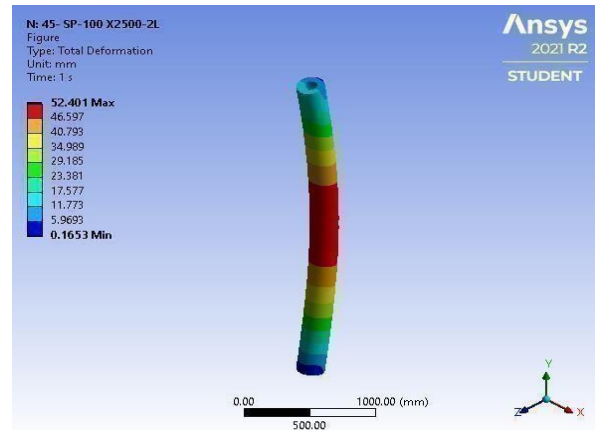

(h)

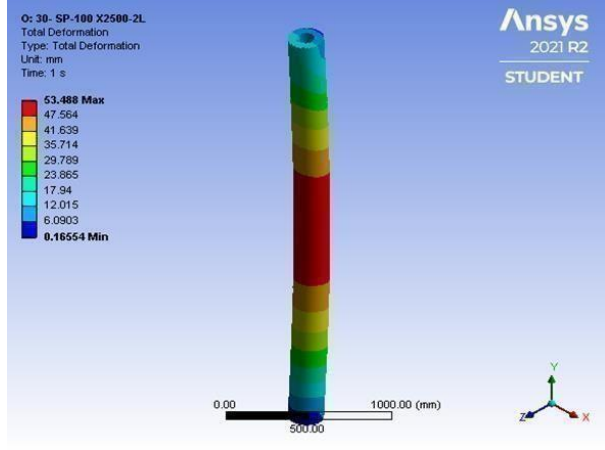

(i)

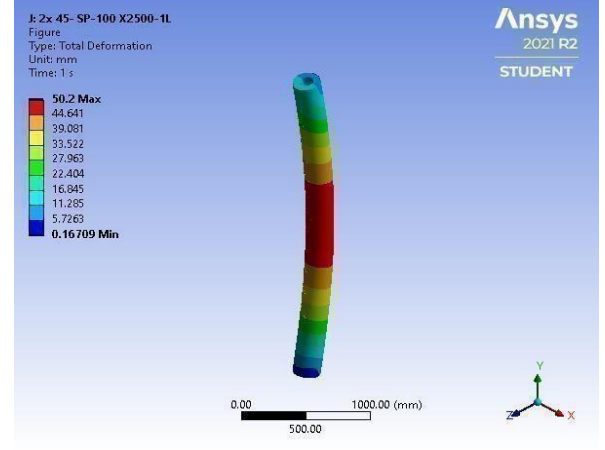

(j)

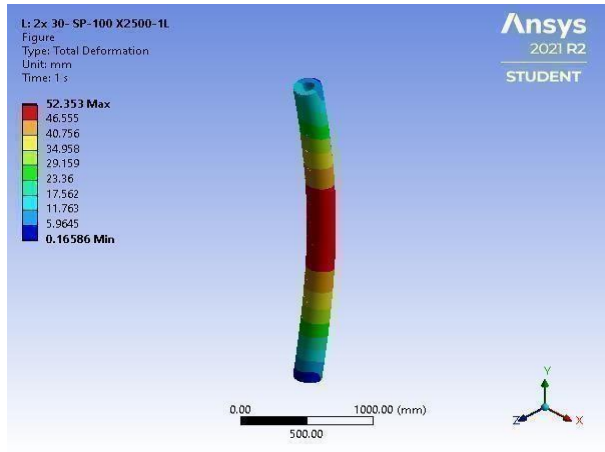

(k)

Fig.6.11 (a) Deformation of CFDST column wrapped with discontinuous 500mmCFRP (b) Deformation of CFDST column wrapped at 45° inclination with discontinuous 500mm CFRP(c) Deformation of CFDST column wrapped at 30° inclination with discontinuous 500mmCFRP (d) Deformation of CFDST column wrapped with discontinuous 2500mm CFRP(e) Deformation of CFDST column wrapped with discontinuous 2500mm CFRP at 45°inclination(f) Deformation of CFDST column wrapped with discontinuous 2500mm CFRP at 30° inclination (g) Deformation of CFDST column wrapped with discontinuous 2 layer 2500mm CFRP(h) Deformation of CFDST column wrapped with discontinuous 2 layer 2500mmCFRP at 45° inclination (i) Deformation of CFDST column wrapped with discontinuous 2 layer 2500mm CFRP at 30° inclination (j) Deformation of CFDST column wrapped with discontinuous 2500mm CFRP at -45° and 45° inclination (k) Deformation of CFDST column wrapped with discontinuous 2500mm CFRP at-30° and 30°inclination The load and deflection comparison of the proposed models under eccentric with discontinuous wrapping in angular alignment under different length and thickness are shown in the table below.

Table.6.5 Comparison of load and ultimate deformation

MODEL	ULTIMATE DEFORMATION(mm)	LOAD(KN)	DIFFERNCE INLOAD
DS	31.94	1022.70	-
0-SP-100 X500-1L	37.03	1050.2	2.69
45 -SP-100 X500-1L	36.73	1040.5	1.74
30-SP-100 X500-1L	36.623	1052.7	2.93
0-SP-100x2500 -1L	36.15	1088.7	6.45
45- SP-100 X2500-1L	30.65	1061.1	3.75
30- SP-100 X2500-1L	36.45	1080.9	5.69
0- SP-100 X2500-2L	35.353	1115.8	9.10
2x 45- SP-100 X2500-1L	39.11	1171.2	14.52
2x 30- SP-100 X2500-1L	27.85	1086.90	6.28
0- SP-100 X2500-2L	35.353	1115.8	9.10
45- SP-100 X2500-2L	41.245	1099.1	7.47
30- SP-100 X2500-2L	35.784	1106.7	8.21

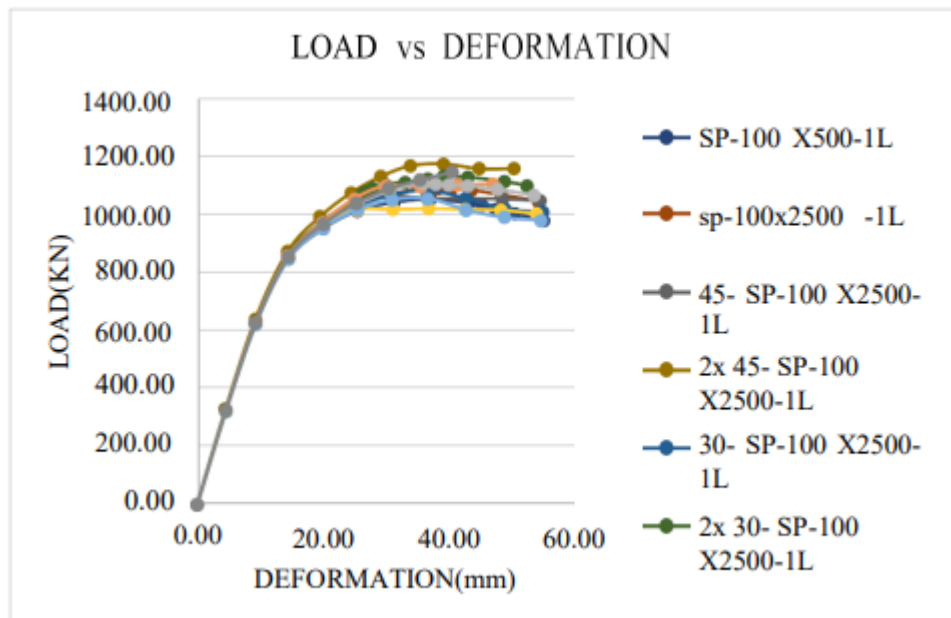

Fig.6.12 Comparison of load deformation curves

On the study of discontinuous wrapping under inclination, while comparing the results of 0° , 45° and 30° of inclination for 500mm length, it is found that there is an increment of about 2.93% and 2.69% for 0° and 30° inclination respectively. So, on comparing the above three cases 30° and 0° performs better than other two cases. On the study after varying the length of discontinuous wrapping from 500mm to 2500mm it is found that there is an increment in load capacity of about 6.45%, 3.75% and 5.69% for 0° , 45° and 30° inclination respectively when compared with CFDST column without FRP confinement. So, we can conclude that among the above mentioned 3 cases 0° performs better than other 2 cases. On adding the number of layers for the above mentioned case, it is found that -45° and 45° configuration of two layer arrangement gives better performance with 14.52% when compared with 0° two layer arrangement with 9.1% and -30° and 30° configuration of two layer arrangement with 6.28%. In the case of 2500mm single alignment inclined combination with 2 layer of wrapping, it is found that maximum of 9.1% increment is for 0° when compared with 45° and 30° which has increment of 7.47% and 8.21% when compared with DS respectively. Upon the angle configuration study on single two layer wrapping 0° gives better performance. In the case of combined inclination 45° wrapping gives the better performance.

VII. CONCLUSION

Concrete filled double skin steel tube column was modelled and analyzed. The study and comparison of confinement effect under eccentric loading on varying different parameters of FRP was carried out.

The following conclusions were obtained:

- Introduction of FRP strengthens the columns and thus gives better performance than CFDST columns without confinement.
- On the study of comparing the performance of various materials, CFRP and GFRP it is observed that CFRP confinement gives the better performance than the GFRP.
- Study of confinement effect under eccentric loading on continuous, discontinuous and angular wrapping under different length, with continuous 500mm CFRP wrapped model it can be observed that 500mm CFRP wrapped model gives effective performance than the discontinuous ones. When comparing continuous 2500mm CFRP wrapped model it can be observed that 2500mm CFRP wrapped model gives effective performance than the discontinuous ones.
- On the study of confinement effect under eccentric loading with discontinuous wrapping in angular alignment under different length and thickness it was found that, comparing the results of 0° , 45° and 30° of inclination for 500mm length, 30° and 0° performs better than 45° . On increasing the length of confinement to 2500mm 0° performs better. Upon the angle configuration study on single two layer wrapping 0° gives better performance. In the case of combined inclination 45° wrapping gives the better performance.

REFERENCES

1. **Ahmed, Mizan, et al.** "Nonlinear analysis of rectangular concrete-filled double steel tubular short columns incorporating local buckling." *Engineering Structures* 175 (2018): 13-26
2. **Han, Lin-Hai, Qing-Xin Ren, and Wei Li.** "Tests on stub stainless steel–concrete–carbon steel double-skin tubular (DST) columns." *Journal of Constructional Steel Research* 67.3 (2011): 437- 452.
3. **Hassan, Aamir, and Ms S. Sivakamasundari.** "Study of Structural Strength and Behavior of Concrete Filled Double Skin."
4. **Huang, Le, et al.** "Circular hybrid double-skin tubular columns with a stiffener-reinforced steel inner tube and a large-rupture-strain FRP outer tube: Compressive behavior." *Thin-Walled Structures* 155 (2020): 106946.
5. **Skaria, Anna, and Mariamol Kuriakose.** "Numerical Study on Axial Behaviour of Concrete Filled Double Skin Steel Tubular (CFDST) Column with Cross Helical FRP Wrappings." *IOP Conference Series: Materials Science and Engineering*. Vol. 396. No. 1. IOP Publishing, 2018.
6. **Talaeitaba, Sayed Behzad, Minoo Halabian, and Mohammad Ebrahim Torki.** "Nonlinear behavior of FRP-reinforced concrete-filled double-skin tubular columns using finite element analysis." *Thin-Walled Structures* 95 (2015): 389-407.
7. **Wang, Jun, et al.** "Mechanical behaviour of concrete filled double skin steel tubular stub columns confined by FRP under axial compression." *Steel and Composite Structures* 17.4 (2014): 431- 452.
8. **Yu, T., et al.** "Behavior of hybrid FRP-concrete-steel double-skin tubular columns subjected to cyclic axial compression." *Thin-walled structures* 61 (2012): 196-203.
9. **Zakir, Mohammad, and Fayaz A. Sofi.** "Experimental and nonlinear FE simulation-based compressive behavior of stiffened FRP-concrete-steel double-skin tubular columns with square outer and circular inner tubes." *Engineering Structures* 260 (2022): 114237.
10. **Zeng, Jun-Jie, Yu-Zhao Zheng, and Yue-Ling Long.** "Axial compressive behavior of FRP- concrete-steel double skin tubular columns with a rib-stiffened Q690 steel tube and ultra-high strength concrete." *Composite Structures* 268 (2021): 113912.

