



# INTERNATIONAL JOURNAL OF CREATIVE RESEARCH THOUGHTS (IJCRT)

An International Open Access, Peer-reviewed, Refereed Journal

## Smart Cradle System

<sup>1</sup>Ms. Diya Karkhanis, <sup>2</sup>Mr. Yogesh Kendre, <sup>3</sup>Ms. Siddhi Hande, <sup>4</sup>Mr. Sagar Dhawale

<sup>1, 2, 3</sup> B.E Students, <sup>4</sup> Assistant Professor

<sup>1</sup>Department Of Electronics and Telecommunication,

<sup>1</sup>Dr. D Y Patil School Of Engineering And Technology, Lohgaon, Pune, India

**Abstract:** The cornerstone of our project is Women Empowerment; by providing them a Smart Cradle System with a special focus on developing countries. This paper proposes the use of "Smart Cradle System" which involves the use of the Internet of Things. The smart cradle incorporates the use of a sound sensor for the detection of the child's crying activity and automatically swings the cradle to soothe the child. The IR contactless temperature sensor notifies the parent about the body temperature of the child, when the temperature of the baby goes above the set threshold. The solution also includes a moisture sensor and gas sensor to maintain the hygiene of the child. The proposed system uses various sensors to monitor the activities of the baby. [3]

**Index Terms - :** Internet Of Things (IOT), Arduino Mega, GSM Module, Sensors, Cradle

### INTRODUCTION

Child care is of most extreme significance for a parent. The present quick paced world makes it hard for parents to continuously look after their kid. After long working hours, it is hard for parents to constantly watch out for their kid. To help such parents, this paper represents the idea of a SMART CRADLE SYSTEM. The smart baby cradle helps working women balance their work and domestic chores. Besides, there are extra features or functions provided by the newly automatic cradle that are beneficial for parents. In this busy life it will be very difficult to control the babies. Moreover, in today's life, it is very hard even for the homemakers to sit near their babies and soothe them whenever they feel uncomfortable. Hence, the use of the Internet of Things helps in dealing with this problem. Smart cradle systems for child monitoring using IoT allows parents to monitor the child.

The main circuits used for this work are sound sensor, moisture sensor, gas sensor and contactless temperature sensor. The proposed work implements a Smart Cradle System for monitoring the baby inside the cradle and measuring the body temperature, monitoring bed wet and smelly diaper condition, automatic swinging of cradle if sound frequency exceeds threshold value and comforting the baby by monitoring room temperature and turning on the fan. Also this system will also notify parents about activities of the baby and activate alarm. Thus, the project bridges the gap between the working parent and their child. The entire system works with the purpose of providing convenience by continuously monitoring every activity of the infant and thereby providing real time details and updates to the parents. [2]

### Objectives

- To design the development of a smart baby cradle, which has the ability to monitor bed-wet, smelly diaper condition, body and room temperature.
- To make a baby cradle safe and comfortable for the baby with the use of various sensors to monitor the baby's life and to check diaper conditions to keep the baby away from an unhygienic environment.
- To make cradle innovation that is more flexible and less expensive to the Indian market. [3]

## Methodology

The working methodology of the proposed smart cradle system is as shown below:

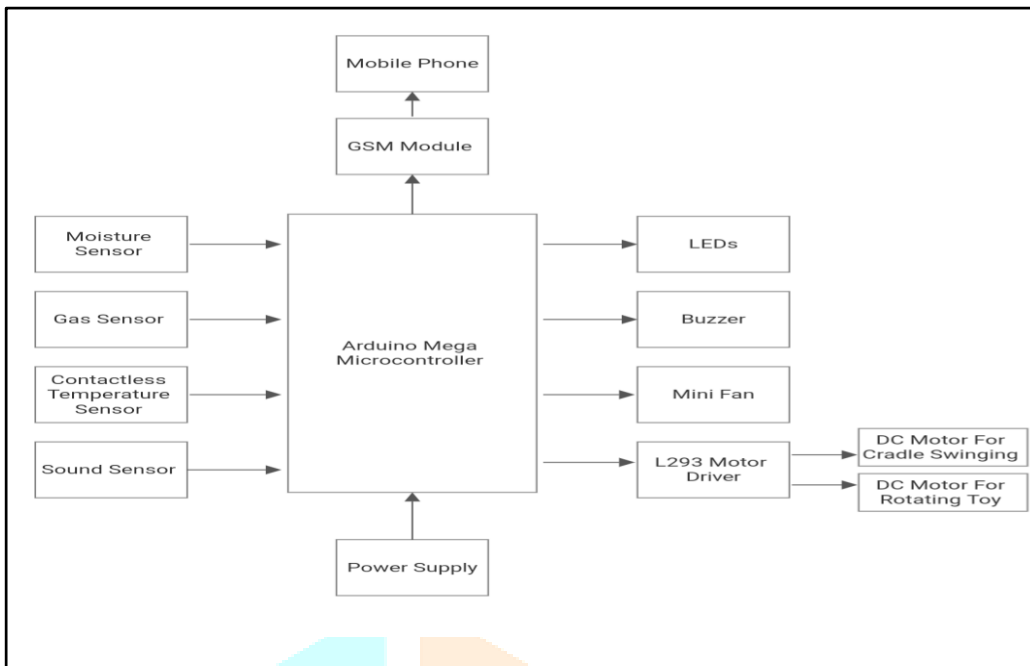

Fig. Block diagram of the proposed system

When the baby is made to sleep on the cradle, various sensors are implemented to monitor minute activities of the baby. Various sensors used are sound sensor, moisture sensor, gas sensor and contactless temperature sensor. Based on the value of sensors, output is given by Arduino accordingly. Swinging of the cradle or turning on the rotating toy is done by DC motors based on input given by the sound sensor. Mini fan is turned on depending on room temperature. LEDs are turned on and SMS is sent to parents if a wet bed or dirty diaper is detected. If body temperature of baby is high then Buzzer is also turned on[2]

## Components

### 1. Sound sensor(KY -037):

- This sensor is used to detect the sound of a baby crying.
- It works similar to our ears. The sound sensor has a thin piece of material called a diaphragm that vibrates when hit by sound waves. The vibration of the diaphragm is converted by the sensor into an electrical signal.
- Frequency range: 50 Hz - 20KHz.
- Power supply voltage: 3.3 - 5V

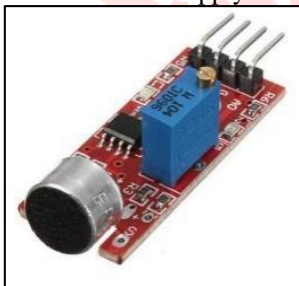

Fig. Sound sensor

### 2. Moisture sensor:

- This is used to detect wetness on bed.
- The fork-shaped probe with two exposed conductors, acts as a variable resistor whose resistance varies according to the water content on the bed. Resistance is inversely proportional to water content.
- Operating Voltage: 3.3V to 5V DC
- Operating Current: 15mA

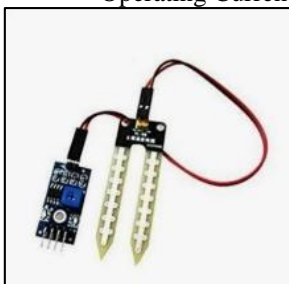

Fig. Moisture sensor

### 3. Gas sensor (MQ-9) :

- This sensor gets activated when a smelly diaper has been detected.
- When the methane gas exists, the sensor's conductivity gets higher along with the gas concentration rising.
- Power supply voltage : 5V
- Operating temperature: -10 to 50°C

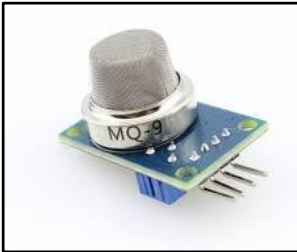

Fig. Gas sensor

### 4. Contactless temperature sensor ( MLX90614) :

- This sensor is used to detect both body and room temperature.
- Although invisible to the human eye, all objects emit infrared light, and the concentration varies with temperature. This sensor transforms the infrared radiation signal collected from objects and bodies into electrical signals.
- Room temperature range: -40°C to 85°C
- Object temperature range: -70 to 382.2°C
- Distance range: 2cm - 5cm.
- Power supply voltage: 5V

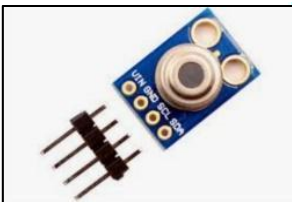

Fig. Contactless temperature sensor

### 5. Arduino Mega:

Arduino Mega is one of the most commonly used hardware in the Arduino series. It is low cost, easily available and is quite compact. The Arduino Mega 2560 is a microcontroller board based on the ATmega2560.

#### Arduino Mega specifications:

- Operating voltage: 5V
- Recommended input voltage: 7-12V
- Analog input pins: 16
- Digital I/O pins: 54 (of which 15 provide PWM output)
- Flash memory: 256KB
- SRAM: 8KB
- EEPROM: 4KB
- Clock speed: 16MHz



Fig. Arduino Mega microcontroller

### 6. GSM module:

SIM900A GSM Module is the smallest and cheapest module for GPRS/GSM communication. The module offers GPRS/GSM technology for communication with the uses of a mobile sim. It uses a 900 and 1800 MHz frequency band and allows users to receive/send mobile calls and SMS.

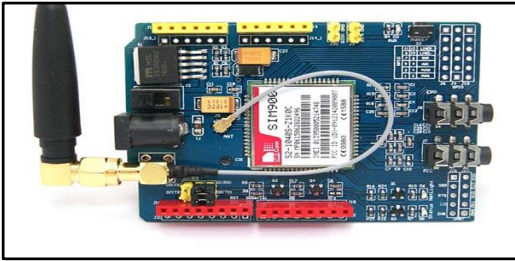

Fig. GSM Module

7. DC motors (2)
8. L293 Motor Driver
9. Red & Yellow LED
10. Mini fan
11. Relay module

## Results and Discussions

### 1. Hardware snapshot

Entire Circuit is interfaced as shown in the figure below. Contactless temperature sensor is connected to Arduino via SDA & SCL Pins. All the other sensors are connected to Analog pins of Arduino. Two DC motors are connected to Digital pins of the arduino through L293 Motor Driver. Mini fan is connected to the Digital pin through the Relay module. LEDs and Buzzer are connected to Digital pins.

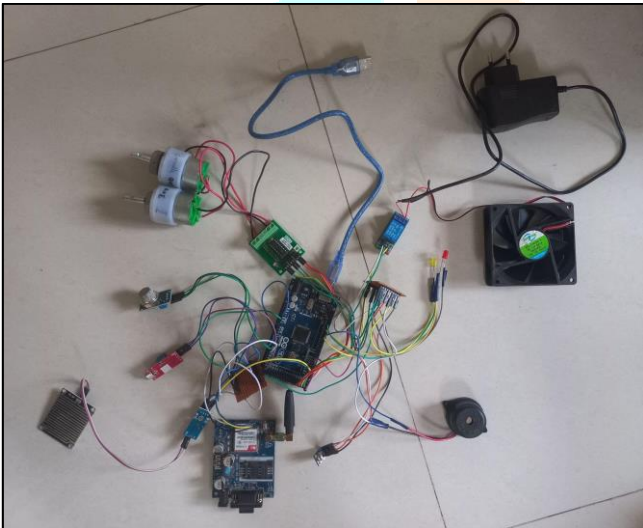

Fig. Hardware Snapshot

### 2. Software Simulation

Software simulation is designed in Proteus Software. We design entire circuit on this software with the help of inbuilt modules and interfaces. No library was available for the Contactless temperature sensor, hence LM35 & DHT11 is used instead of MLX90614 only for simulation purpose. While implementing, Contactless temperature sensor(MLX90614) is used. Software design is Simulated via hex file uploading in Arduino Mega microcontroller. Circuit programming is done in Arduino IDE software and compiled in itself.

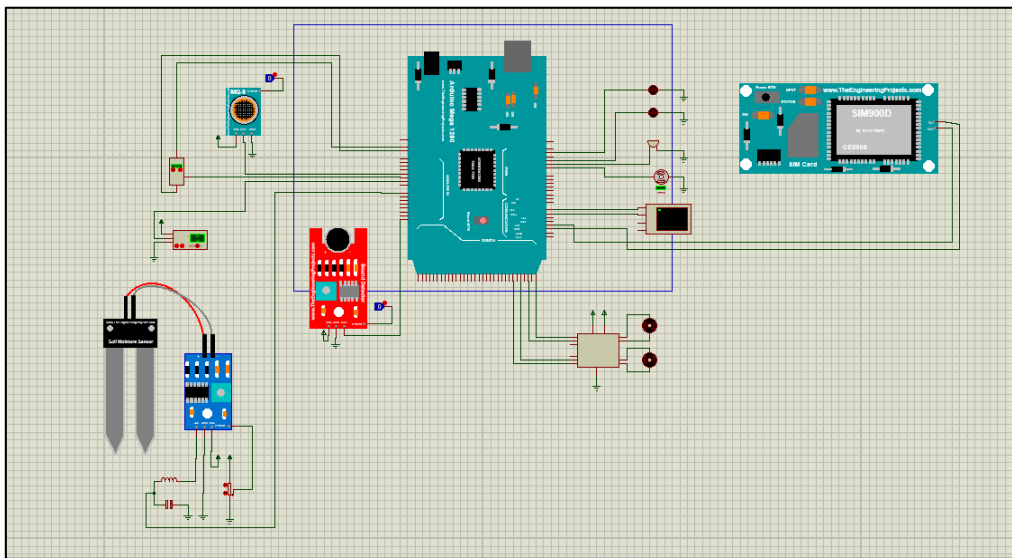
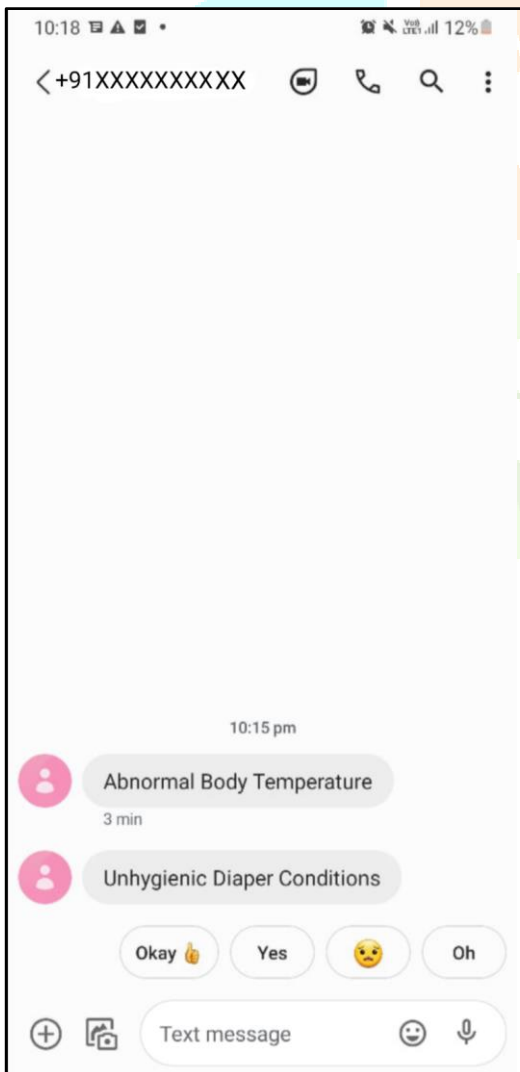

Fig. Software Simulation

### 3. Results

When the sensor value exceeds the set value, SMS is sent to the parent's mobile phone with the help of the GSM module. Snapshot of the message is shown below. Also values of all the sensors are displayed on the Serial monitor. Snapshot of Serial monitor is shown below.



```

COM6
Sound Frequency = 50.52

gas=271
Moisture on bed in percentage = 3.00%
Room Temperature = 31.81°C
Body Temperature = 31.53°C
Sound Frequency = 49.82

gas=271
Moisture on bed in percentage = 3.00%
Room Temperature = 31.81°C
Body Temperature = 31.47°C
Sound Frequency = 49.53

gas=271
Moisture on b
  
```

Autoscroll    Show timestamp   Newline   9600 baud   Clear output

Fig. Result

## Conclusion

- Growth of technology has been rapidly increased. Since technology has been developed greatly it can contribute to society in various ways. One of its applications is Smart Cradle System.
- Looking after babies is a hard problem worldwide. This system emphasizes the importance of child care. It is economical, user friendly and very useful for working mothers and nurses.
- They can manage their work efficiently.
- The present work reduces the human effort and particularly mother's stress in working times. [1] [3]

## Future Scope

- To enhance the security of the baby, apart from the basic requirement more modules can be added like Camera.
- One of the most important features that can be added to this device is that a trigger can be added in such a way that if the parents are very far away in a different city or they could not reach their baby then through the app they should be able to trigger an emergency call with the nearest police station.
- For this GPS services can be included. This ensures expert level safety for the child. [4]

## References

1. Harshad Suresh Gare, Bhushan Kiran Shahane, Kavita Suresh Jori, Sweety G. Jachak "IoT Based Smart Cradle System for Baby Monitoring" IJCRT Volume 8, Issue 3 March 2020
2. Amol Srivastava, B. E. Yashaswini, Akshit Jagnani, Sindhu K "Smart Cradle System for Child Monitoring using IOT" (IJITEE) Volume-8 Issue-9, July 2019
3. Development of IoT Based Smart Baby Cradle Prof. A.B. Tupkar, Prajwal. Chahare, Shubham. Rade, Rushikesh. Wakade, Snehal. Bahirseth
4. A Smart Baby Cradle by Savathri Ramesh Associate Professor, Syed Abrar Associate Professor, Hanidia Misbah SS, D Padma Bhavani, Mamtha H.L & Madhushree, Volume 19 Issue 1 Version 1.0 Year 2019
5. IoT-BBMS: Internet of Things-Based Baby Monitoring System for Smart Cradle by Waheb A. Jabbar, Hiew Kuet Shang Saidatul N. I. S. Hamid, Akram A. Almohammed, Roshahliza M. Ramli, and Mohammed A. H. Ali , IEEE, July 2019