



# A Study on Wind Analysis of Elevated INTZE Tank Using Different Arrangements of Bracing System

<sup>1</sup>ketan Ashok Akolkar, <sup>2</sup>K.S.Patil, <sup>3</sup>Dr. N.V.Khadke

<sup>1</sup>PG Student, Department of Civil Engineering, JSPM's Imperial College of Engineering and Research Wagholi, Pune, Maharashtra, India, <sup>2</sup> Assistant Professor, Department of Civil Engineering, JSPM's Imperial College of Engineering and Research Wagholi, Pune, Maharashtra, India. <sup>3</sup> Professor and Head of Department, Department of Civil Engineering, JSPM's Imperial College of Engineering and Research Wagholi, Pune, Maharashtra, India.

**Abstract:** Due to enormous need by the public, water has to be stored and supplied according to their needs. Water demand is not constant throughout the day. It fluctuates per hour. We need to store water in order to deliver a consistent volume of water. As a result, a water tank must be built to accommodate the public water demand. Water, petroleum products, and similar liquids are stored in storage reservoirs and overhead tanks. Regardless of the chemical nature of the product, the force analysis of reservoirs or tanks is similar. To prevent any leakage in the construction, all tanks are constructed as crack-free structures. Elevated Water storage tanks, or water retention structures, are an integral part of any distribution system. During periods of low demand, water is pumped into the storage tank, and during periods of high demand, water is pumped out of the storage tank and into the distribution system. The major aspect of design in conventional constructions is structural stability and load resistance. However, in addition to structural stability, resistance, and appropriate strength against deformation and cracking, structures meant to store liquids should be resistant to perforation and dripping. This project gives in brief, the analysis behind the design of elevated INTZE structure using the software STAAD pro V8i. To determine the roof displacement and base shear values for the elevated water tank. In this study different winds speeds are considered for analysis.

**Index Terms –** Elevated Water tank, INTZE tank, Design, Stability, STAAD pro, Roof displacement, Base shear.

## 1. INTRODUCTION

Elevated water tanks are crucial structures that must be able to perform as expected, i.e. continue to function during and after heavy winds. It's very challenging to analyze a hydrodynamic structure like an elevated concrete water tank. This could be due to a lack of understanding of the tank's supporting system's proper behaviour due to the dynamic effect, as well as incorrect geometrical staging selection. Water is stored in a water tank to meet the daily requirement. The imperviousness of concrete is critical in the construction of concrete structures for the storage of water and other liquids. The water cement ratio determines the permeability of any homogenous and properly compacted concrete of given mix proportions. The increase in the water cement ratio has a number of consequences.

## 1.2 WATER TANK IN GENERAL AND TYPES OF WATER TANK

Water supply projects have received a lot of attention in recent years all over the world, and they are critical for the country's social and industrial growth. Water tanks come in a variety of capacities, depending on the amount of water consumed. Water tanks are divided into three categories based on their location:

1. Water tanks buried underneath
2. The tank is sitting on the ground.
3. Water tanks that are elevated.

The water tanks are also divided into categories based on their shape:

1. Circular tanks
2. Rectangular tanks
3. INTZE tanks
4. Circular tank with conical bottom
5. Spherical tanks.

### 1.3 ELEMENTS INTZE WATER TANK

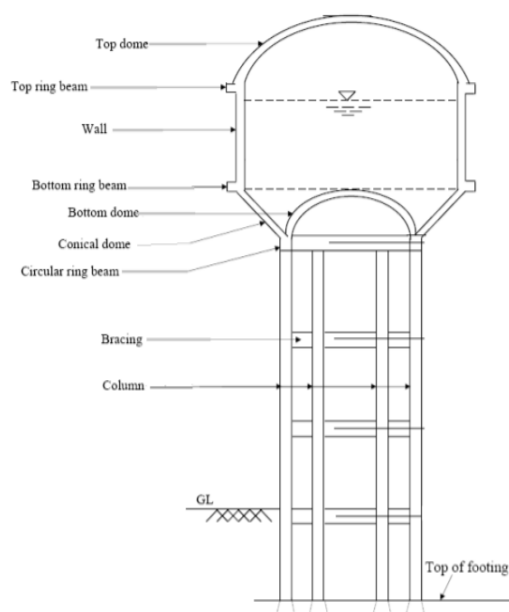

Figure1.3: Components of INTZE Water Tank

## 2. LITERATURE REVIEW

Niraj Kumar Soni et. Al (2020) Studied hydrostatic analysis of INTZE type elevated water tank. To make the design economical they have done the parametric study in which they vary the staging container diameter ratio, horizontal angel of dome, number of columns for design of staging etc. to analyze this model they have used the software STAAD PRO and manual calculations has been done. They conclude that as H/D ratio decreases with node displacement in vertical downward direction and the maximum support reaction decreases by 34% at H/D ratio 1.5 as compared with 0.5.

Mohammed Quais Khan et. Al (2019) Studied the design of INTZE water tank as per the norms in IS:3370, IS 800:2002, IS:875. In this study they have design all the members of INTZE water tank including dome, ring beam supporting the dome, cylindrical wall, ring beam at junction, conical slab, ring girder, column, tower with bracing etc. They have made a 2D model in the STAAD PRO software. They conclude that horizontal forces like wind and earthquake can affect the design of the structure.

Chetan Agari et. Al (2019) Studied the seismic analysis of INTZE water tank. They study for stability of elevated water structure during seismic activity. They have considered the four seismic zones for the study. They used the STAAD PRO software to analyze the model and to determine the values of displacement, maximum bending moment, base shear and maximum shear force under different zones. They conclude that the bending moment values are changing in staging due to different bracings.

Ajmal Tokhi et. Al (2019) Design of elevated tank is complex and requires a lot of calculation and time. Capacity of all tanks is 45000litres holds up on RCC frame of stage height of 27m. Time period is more in tank others in full filled condition and is dependent of zones. In all condition, base shear in circular tank is less than that of INTZE tank in seismic zone 3.

R Uma Maheshwari Rao et. Al (2018) Studied the effects of lateral forces produced by wind and seismic waves on tank. In this they study some parameters like axial forces, bending moment, shear force etc. and these parameters are then compared for different structures. They use the finite element method for analysis. They have used the STAAD PRO V8i software for analysis. They found bending moment at the top of the tank is 29.086kNm with shear force of 28.59kN.

ISSAR Kapadia et. Al (2017) Studied the structural analysis of all elements of tanks using IS codes. It includes the elements like dome, ring beam supporting the domes, cylindrical walls, conical wall, conical slab, floor of the tank, ring girder, column and foundation. To study the hydrostatic forces acting on tank, a 3D model is prepared in STAAD PRO software. They conclude that when the height of structure increases, it causes the increase in moment.

Shriram Nagarao Bengal et. Al (2017) Studied the rectangular and circular water tank of constant staging height of 12m, under the influence of seismic forces. As per IS 1893:1984/2002 for design of seismic structure. The design of the was carried out in the software STAAD PRO V8i. they have taken the capacity of tank as 100 cubic meter for both shapes. Tank was tested under full

filled and empty condition. They conclude that the base shear in full filled tank is slightly higher than that of empty tank and shear force generated is slightly higher in full filled tank than the empty tank.

Sonali M Pole et. Al (2017) In this paper, they have studied different pattern of staging with different type of storage capacity of tanks. They used two types of staging system cross bracings and radial bracings at various fluid level for the comparison. They perform their study on the STADD PRO V8i software. They find out the parameter like overturning moment, base shear and roof displacement. They conclude that base shear as well as base moment is less for empty tank as compared to fully filled water tank.

Ankush N Asati et. Al (2016) They have studied the dynamic analysis for the circular tank considering the seismic forces. They have used various staging system like normal, cross and radial. They used the SAP2000 software to analyze the structure for above parameters. They conclude that the radial arrangement with six staging level is best.

Neeraj Tiwari et. Al (2015) In this, they have studied the conventional analysis for overhead water tank assuming the column rests on yielding support. They have taken the deformable soil strata for the study. They used the ANSYS software to carry out their 3D model. They study the parameter like resultant deflection, Von-mises stress, natural frequency of tanks. They evaluate the natural frequency of tank for different filling conditions and comparison is made between the non-interaction and interaction analyses.

### 3. METHODOLOGY

In this project elevated INTZE tank is considered and normal, Rectangular and radial bracing system is applied by considering the full half and empty tank conditions. Analysis is made for roof displacement and base shear values for the above tank conditions for wind velocity of 47m/s and 55 m/s and they are compared to know which bracing system gives the best result in terms of roof displacement and buckling.

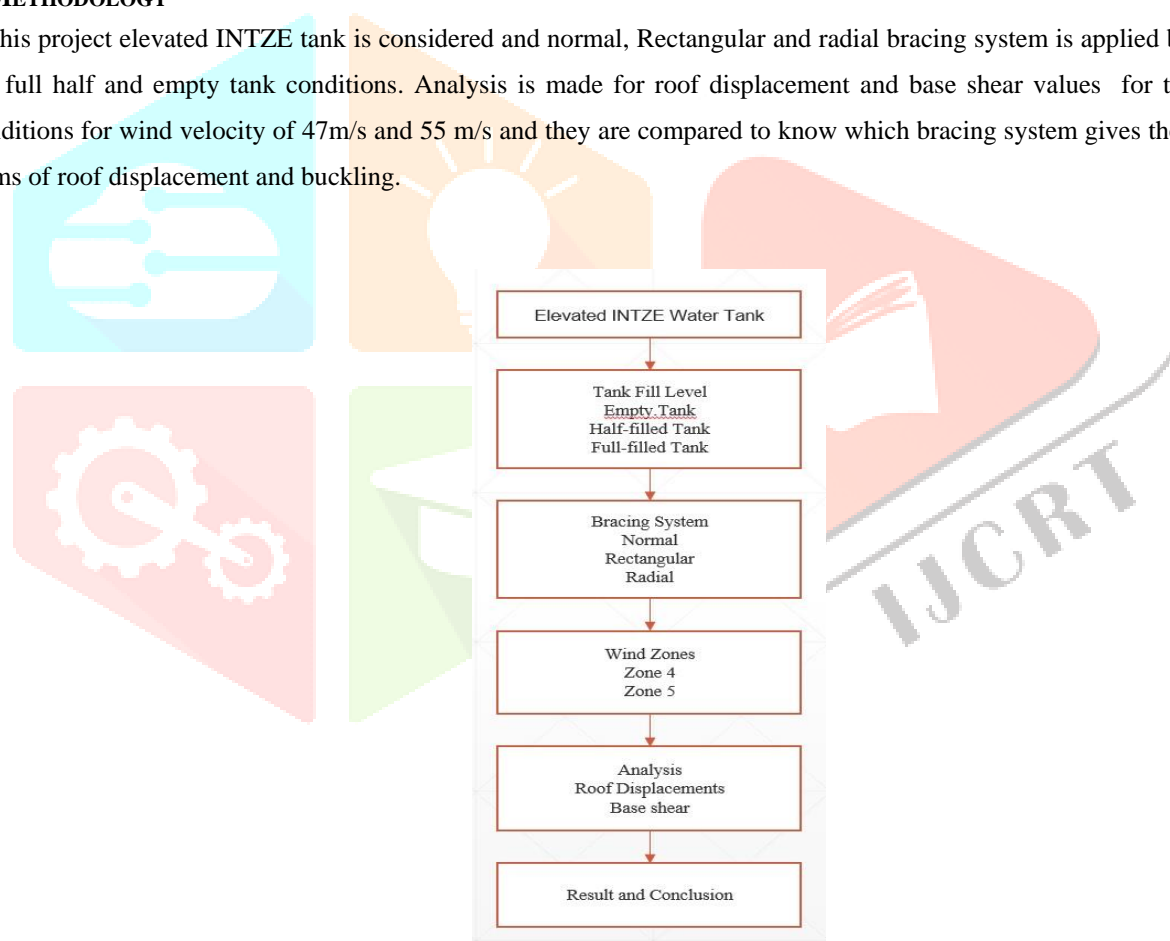

Figure3.1: Flow Chart of Methodology

#### 3.1 Structural Details

Storage Capacity: 300000 litres.

Height of Staging: 15m.

S.B.C. of soil: 200 KN/sqm.

Grade of Concrete: M30.

Diameter of Tank: 8m.

Table No.5.2: Description of Elevated INTZE Water Tank

Sr. No	Parameter	Values
1	Thickness of Top Dome	100mm
2	Rise of Top Dome	1.5m
3	Size of Top Ring Beam	230X200mm
4	Diameter of Cylindrical Wall	8m
5	Height of Cylindrical Wall	4m
6	Thickness of Cylindrical Wall	230mm
7	Size of Middle Ring Beam	250X500mm
8	Height of Conical Dome	1.5m
9	Average Diameter of Conical Dome	7.2m
10	Thickness of Conical Dome	200mm
11	Rise of Bottom Dome	1.2m
12	Radius of Bottom Dome	3.2m
13	Thickness of Bottom Dome	200mm
14	Size of Bottom Ring Girder	400X600mm
15	Number of Columns	8
16	Diameter of Columns	450mm

### 3.2 Design in STAAD pro

#### 1. Geometry of structure

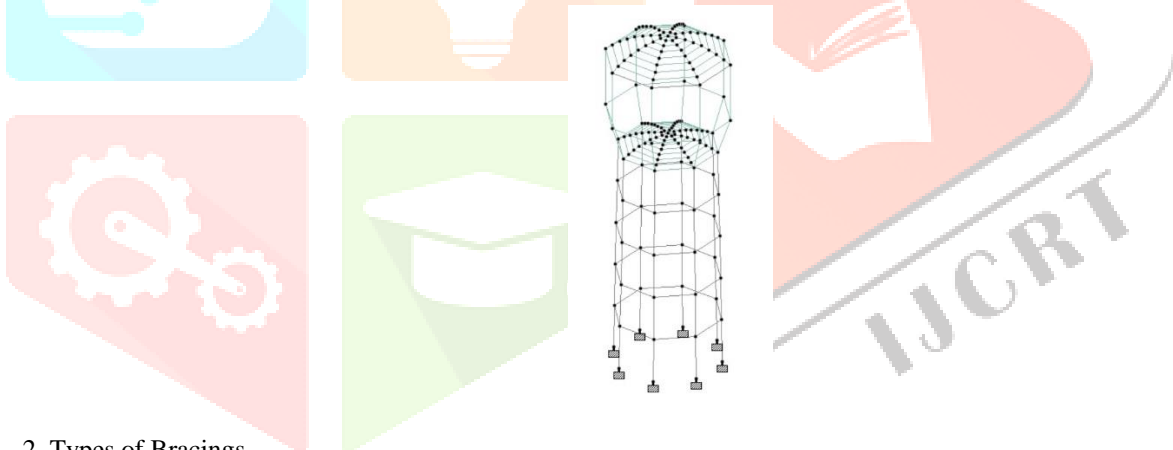

#### 2. Types of Bracings



Fig: Normal Bracing

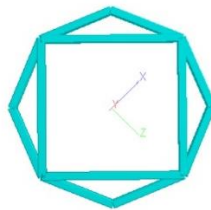
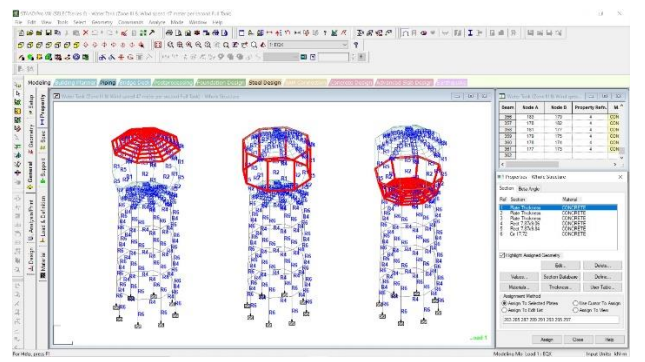
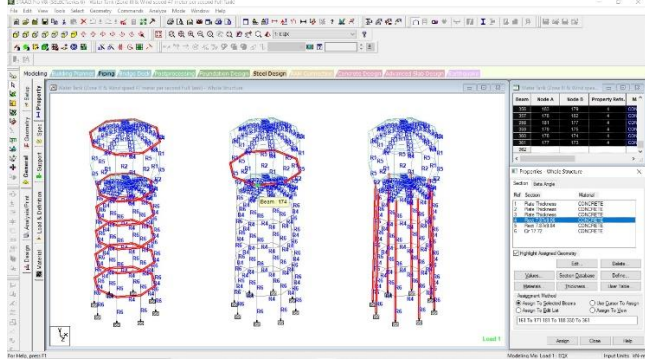

Fig: Rectangular Bracing

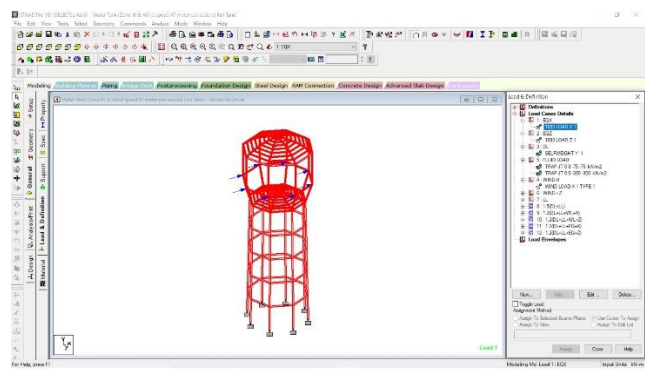
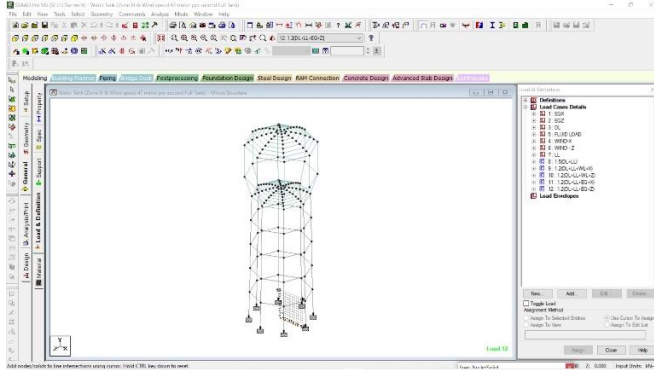

Fig. Radial Bracing

### 3. Assign Material Properties



### 4. Define Loads



### 5. Assign Supports

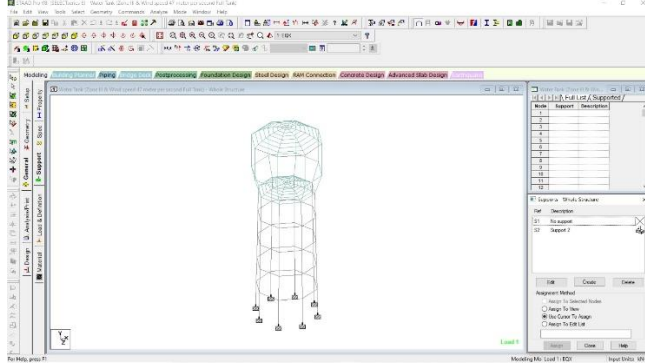

### 6. Analysis and check for Zero Errors

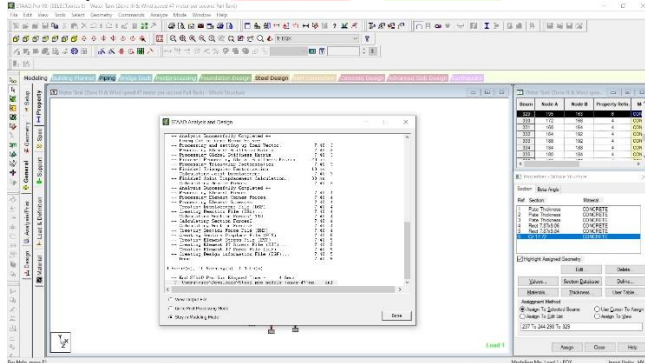

7.Go to Post Processing

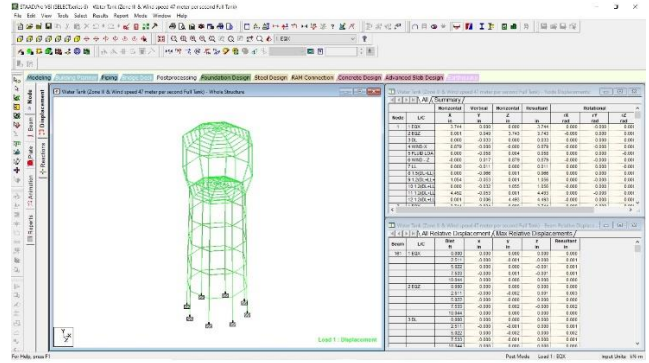
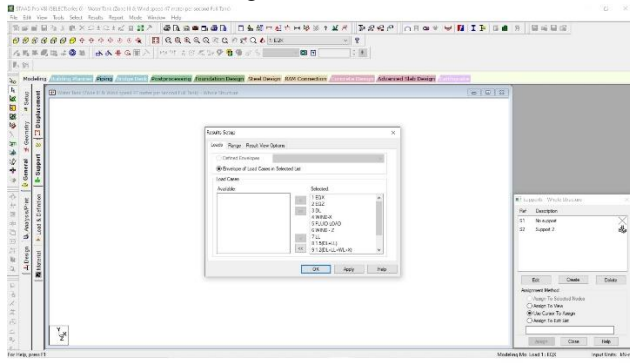

8.Analysis of Results

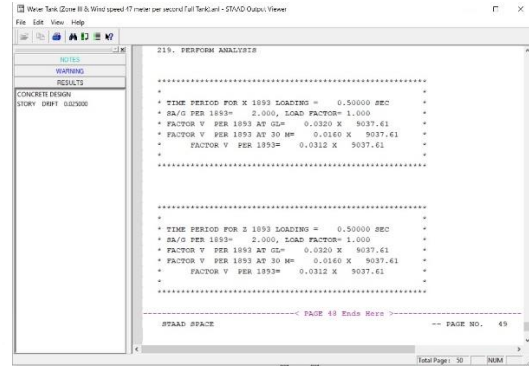
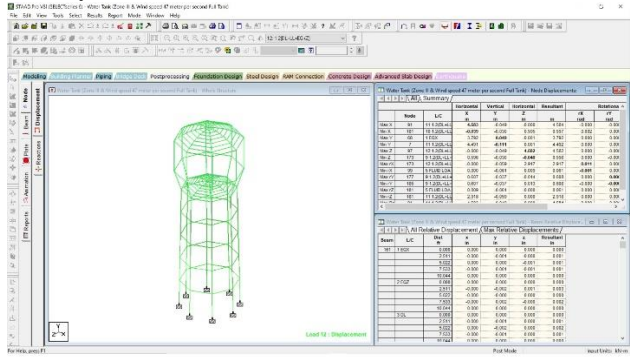

4. RESULT AND DISCUSSION

4.1Roof Displacement Values (mm)

By implementing the wind force to the STAAD pro model, we observed the Roof displacement for Empty Tank, Half-filled Tank and Full-filled tank. The below table shows the Roof Displacements for Normal, Rectangular and Radial Bracing system at different wind speeds in Zone 4 and Zone 5.

Table: Roof Displacement Values

TANK CONDITION	BRACING SYSTEM	ROOF DISPLACEMENT(MM)	
		47m/s	55m/s
Empty	Normal	24.469	27.625
	Rectangular	22.417	24.243
	Radial	18.635	19.069
Half-filled	Normal	68.859	68.902
	Rectangular	61.46	61.463
	Radial	49.739	49.737
Full filled	Normal	116.421	116.421
	Rectangular	103.252	103.252
	Radial	82.896	83.014

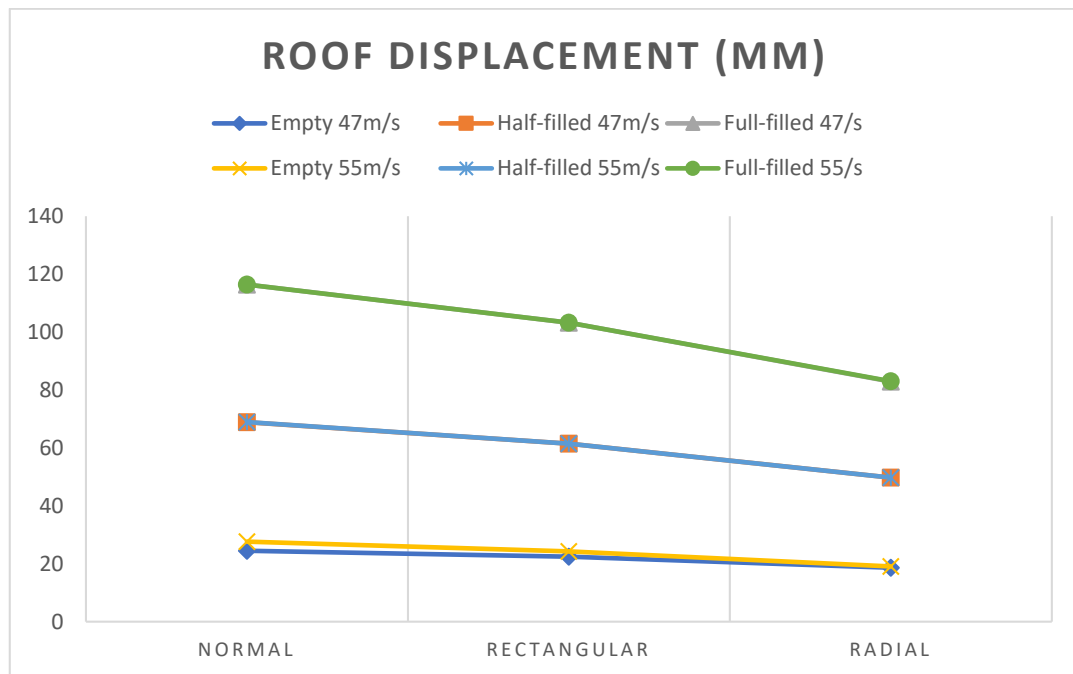

#### 4.2 BASE SHEAR (KN)

By applying the loads on STAAD pro model for different Tank conditions Empty, Half-filled and Full-filled. The below results are obtained for Normal, Rectangular and Radial Bracings.

Table: Base Shear Values

TANK CONDITION	BRACING SYSTEM	BASE SHEAR (KN)
Empty	Normal	60.39
	Rectangular	62.935
	Radial	65.85
Half-filled	Normal	167.35
	Rectangular	169.916
	Radial	172.83
Full filled	Normal	281.97
	Rectangular	284.53
	Radial	287.458

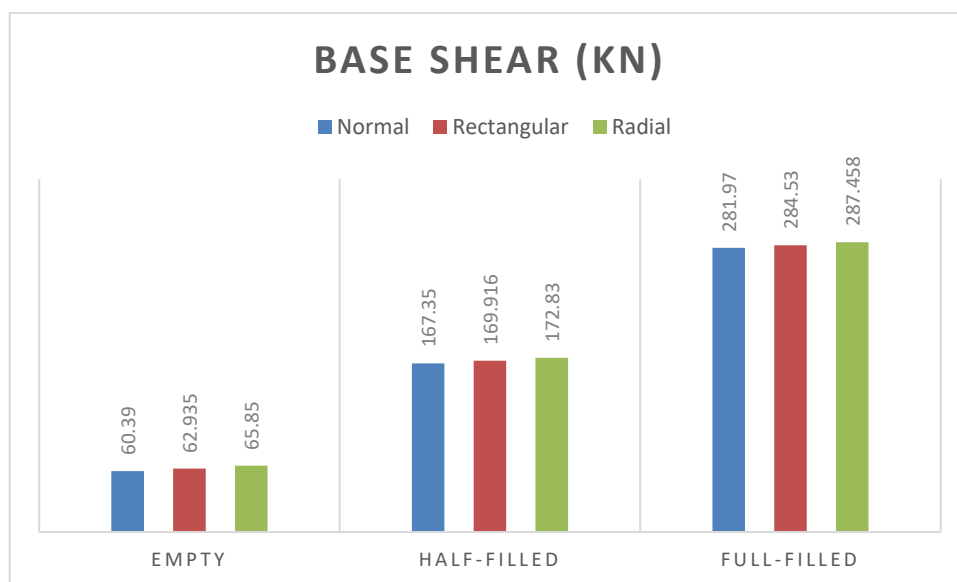

## 5. CONCLUSION

1. It is observed that the Roof displacement is higher for Full-filled condition than that of Half-filled and Empty condition for all the types of bracings i.e. for Normal bracing, Rectangular Bracing and Radial bracing. For both wind zone.
2. It is observed that Radial bracing shows the least Roof Displacement as compare to Normal and Rectangular Bracing for Wind zone 4 and Wind zone 5. For all tank condition i.e Empty, Half-filled and Full-filled.
3. From the results it is observed that Base Shear is more for Full-filled condition for all types of Bracings than Half-filled and Empty condition.
4. It is observed that the Base shear values for Normal Bracing is less as compared to Rectangular Bracing and Radial Bracing.
5. From above Results it is concluded that Radial Bracing is more Suitable type of Bracing. As it provides minimum Roof Displacement and more Structural Stability.

## 6. ACKNOWLEDGEMENT

I would like to acknowledge with thanks to my guide Prof. K. S. Patil, Head of Department Dr. N. V. Khadake and PG Coordinator Prof. V.P. Bhusare for their valuable suggestions and continuous encouragement. I also thanks to my family member for their continuous support during the work.

## REFERENCES

- [1] I.S:456-2021. Indian Standard Code of Practice for Reinforced Concrete.
- [2] I.S:875-2015 Part-III code design of wind loads.
- [3] Text book: Design of Reinforced Concrete Structures by S.Ramamrutham.
- [4] I.S-3370 (Part IV-2021). Code of Practice for Concrete Structures for the storage of liquids.
- [5] I.S-3370 (Part II-2021). Code of practice for concrete structures for the storage of liquids
- [6] Ketan Ashok Akolkar, k.S.Patil. "A Reiew Paper on Wind Analysis of Elevated INTZE Tank Using Different Bracing System" Vol.04, Issue.04,2022.
- [7] Niraj Kumar and Dr. Pankaj Singh, "Parametric study of INTZE water tank with varying height to diameter ratio using STAAD PRO", International journal of civil and structural Engineering Research, Vol-7, Issue-2, pp.39-43, march 2020
- [8] Issar Kapadia, Purav Patel, NileshDholiya, "Parametric study of RCC staging (support structure) for overhead water tankas per IS: 3370", IJAERD, Vol-4, Issue-1, 2017.
- [9] Mohammad Quais Khan and Mr. Baber Hussain, "Analysis and design of INTZE water tankas per IS: 3370 and IS: 456-2000 using STAAD PRO software", IJAERD, vol- 5, Issue-6, 2019
- [10] ChetanAgari, V.K Verma& Aman Gupta "Seismic analysis of INTZE water tank with different bracing configuration", International Journal of Research in Engineering, Science and management, Vol-2, Issue-8, August 2019.
- [11] Tokhi Ajmal & Sahil Arora, "Seismic analysis of elevated water tank, circular water tank and rectangular and response spectrum analysis", International Journal of Civil engineering and Technology, Vol-10, Issue-3, March 2019, pp. 2519-2527.
- [12] R.Umamaheswara Rao, P.Goverdhan, Divyavani .B,Vidya "Analysis and design of RCC overhead water tank for seismic and wind loads", Indian journal science research, 17(2): 425-428,2018.
- [13] Issar Kapadia, Purav Patel, NileshDholiya, Nikunj Patel "Analysis and Design of INTZE type overhead water tank under the



- hydrostatic Pressure as per IS: 3370 & IS 456-2000 by using STAAD PRO software “International Research Journal of Engineering and Technology (IRJET)”, Vol-04, Issue-07, July 2017.
- [14] Shriram Nagarao Bengal, Sandip A. Tupat “Seismic analysis of elevated water tank with variation of H/D ratio and container shape”, International Journal of computer science and mobile computing, Vol-6, Issue-5, pg. 209-217, May 2017.
- [15] Sonali M. Pole Professor, Amey R. Khedikar “Seismic Investigation of RC elevated tank for different types of staging system”, International Journal of Innovative Research in Seismic Engineering and Technology, vol-6, Issue-7, July 2017.
- [16] Ankush N. Asati, Mahendra S. Kadu, S. R. Asati “Seismic analysis and optimization of RCC elevated water tank using various staging patterns”, International Journal of engineering research and application, ISSN:2248-9622, Vol-6, Issue-7(part 1), July 2016.
- [17] Neeraj Tiwari and M. S. Hora “Transient analysis of elevated INTZE water tank-fluid-soil system”, ARPN Journal of Engineering and Applied Sciences, Vol-10, February 2015.
- [18] Rupachandra J. Aware, Dr. Vageesha S. Mathada “Seismic Performance of Circular Elevated water tank”, International Journal of Science and Research (IJSR) ISSN, Vol-4, Issue-12, December 2015.
- [19] Prasad S. Barve & Ruchi P. Barve “Parametric study to understand the seismic behaviour of INTZE tank supported on shaft”, International Journal of Engineering sciences and Research Technology, Vol-4 (version 7), pp.161-168, July 2015.
- [20] Ankita R Patil and Dr. S. A. Balchandra “Effect of different staging configuration on seismic performance of circular elevated water tank”, International Journal of Engineering Research and Applications, Vol-4, (Version 6), pp. 39-43, August 2014.
- [21] Cherukupally Rajesh and Sudip Jha, Professor P. Shrilaskhmi “Seismic Behaviour of an elevated water tank for different staging height”, International Journal and magazine of Engineering Technology, Management and Research, 2014.
- [22] Gaikwad Madhura V, Prof. Mangulkar Madhuri N, “Comparison between Static and Dynamic Analysis of Elevated Water Tank”, International Journal of Scientific and Engineering Research, Vol-04, Issue-06, 2013.
- [23] Manish N. Gandhi, Prof. A. Rajan, “Necessity of Dynamic Analysis of Elevated Water Storage Structure Using Different Bracing in Staging”, International Journal of Research in Advent Technology, Vol-02, 2014.
- [24] Suchita Hirde, Ms. Asmita Bajare, Dr. Manoj Hedao, “Seismic performance of elevated water tank”, International Journal of Advanced Engineering Research and Studies, 2011.

