



INTERNATIONAL JOURNAL OF CREATIVE RESEARCH THOUGHTS (IJCRT)

An International Open Access, Peer-reviewed, Refereed Journal

Lined Men's Suit

Project Based Learning Materials



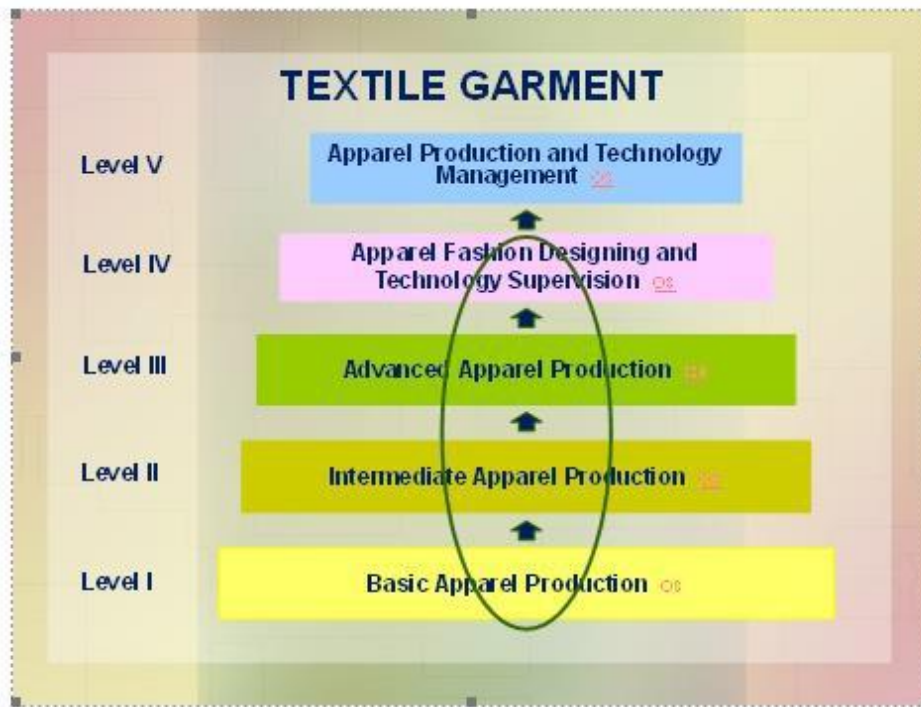

The project covers the occupation of garment primarily in Basic Apparel Production Level 1 leading to Advance Fashion Designing and Technology Enhancement Level IV as encircled above on the occupational map with focus to Produce Simple and Fashion Designing



Project Matrix

Project Title :	APPAREL FASHION AND DESIGNING TECHNOLOGY SUPERVISION ENHANCEMENT
Product (s) :	Lined Men's Suit Lined Men's Trouser
Covered Occupation:	Basic Apparel Production Level 1 Intermediate Apparel Production Level 2 Advanced Apparel Production Level 3
Focus Competency:	Apparel Fashion Designing and Technology Supervision L4 Produce Simple and Apparel Fashion Designing Technology Enhancement
Competency Based Training Matrix	
Core Elements	Integrated Competency
Prepare garment	Draw and interpret Design L1
	Take Body Measurements / international sizing L1
	Prepare Basic Pattern L1
	Develop Pattern L2
	Interpret Pattern and apply pattern information L2
	Prepare Sewing Machine L1

component	Sew garment PartsL1
	Perform Job costing and estimate
	Mark, Lay-up and Cut Complicated Fabrics and Lays L2
	Measure and cut commercially tailored garment L3
	Bundle and Label cut fabric
Sew Garment Parts and assemble commercial tailored garment	Prepare Sewing Machine L1
	Perform industrial sewing machine minor servicing L1
	Sewing garment parts L1
	Perform hand stitching L1
	Contribute to garment production process improvement L2
	Assemble commercially fit garment L3
	Prepare Prototype L4
Finishing	Operate specialize Industrial machine L1
	Apply Quality Control L1, L2, L3

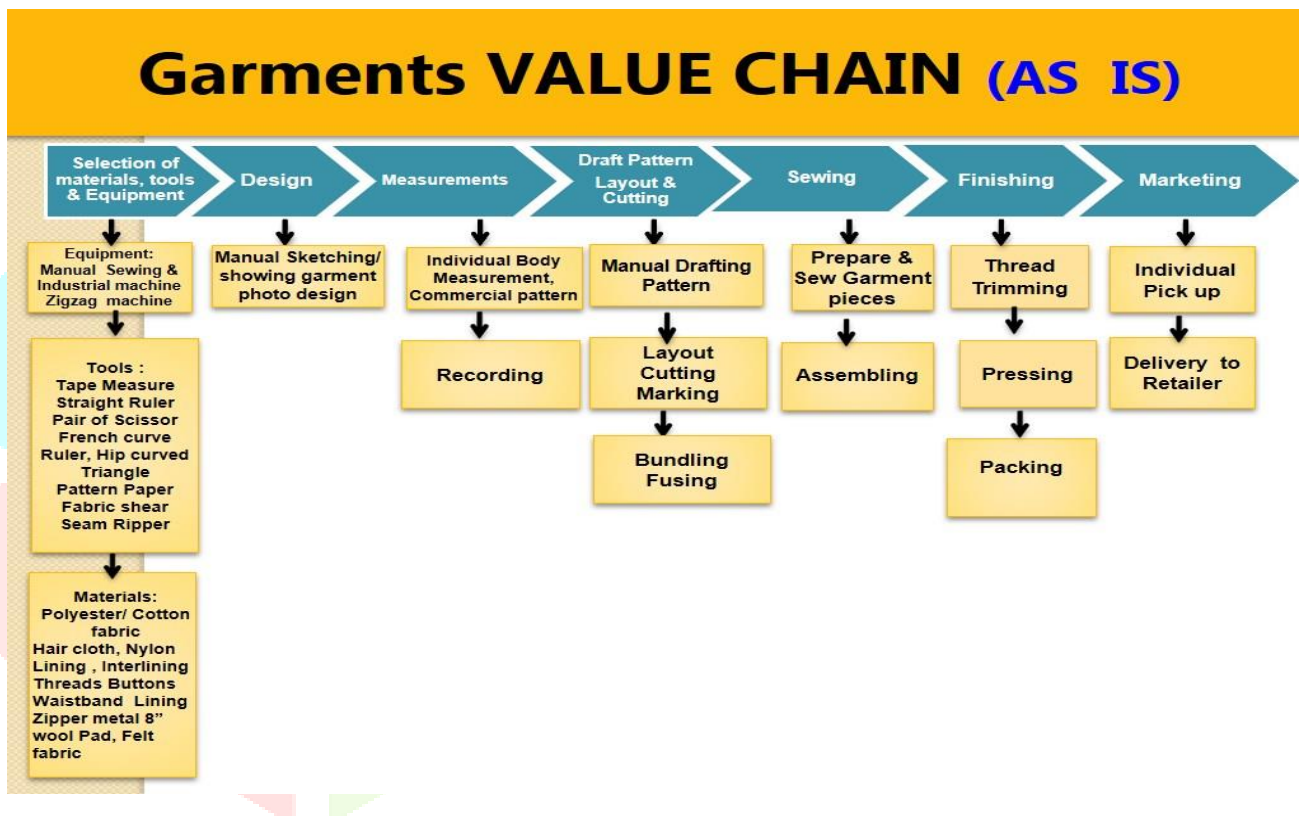

Garments VALUE CHAIN (Gap)

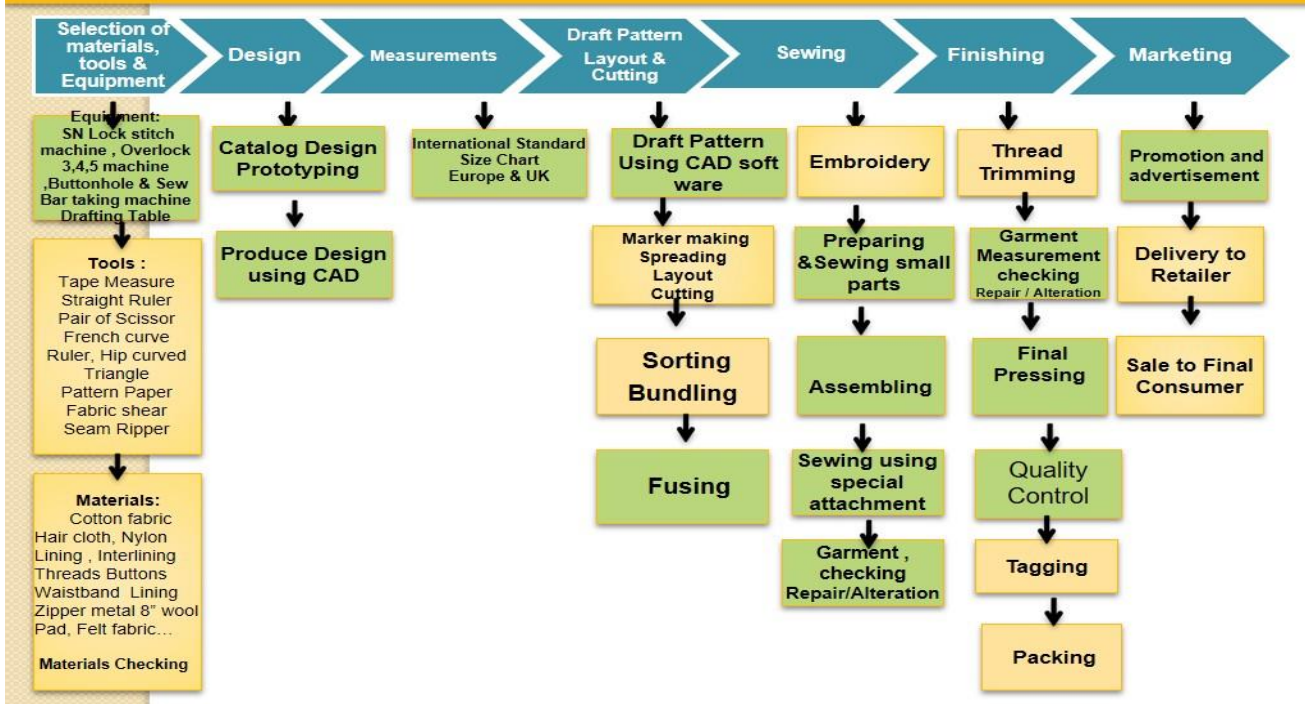

100% COPY TECHNOLOGY by Model Approach

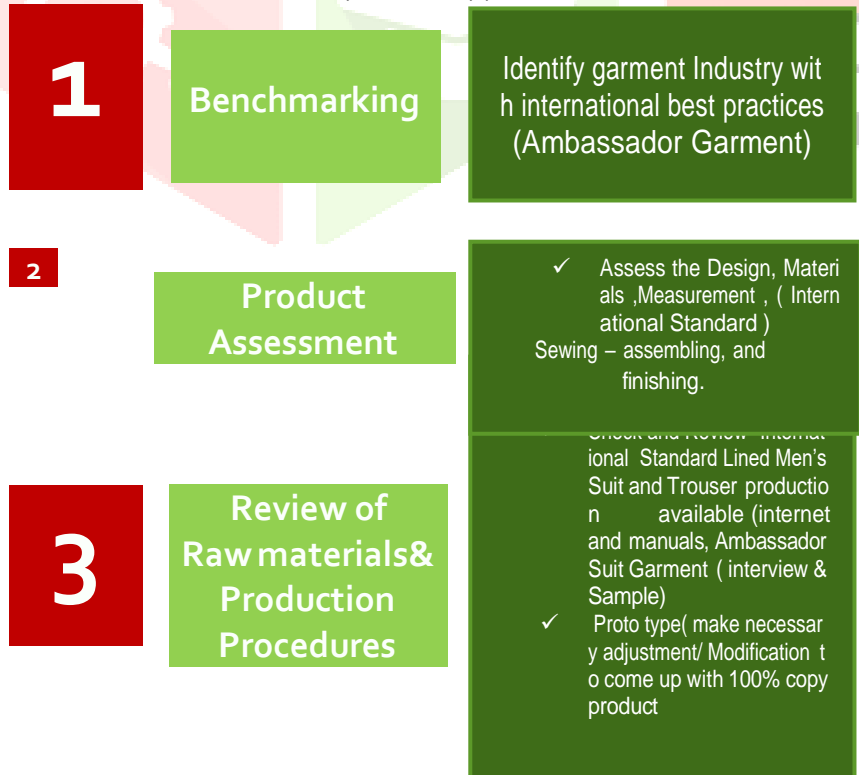

100% copying in Apparel Fashion Design and Technology & supervision Enhancement means is the replica of the original Lined Men's suit and Trouser Thru by Model approach



4

Finalized product operation procedure

✓ Produced 100% copy product

Abstract

The emerging growth and development in clothing lifestyles are apparently observed in the country, which was resulted to the improvements of local fashion and creativeness to design apparel, manifested the industries a business to venture.

The project developed to highlights narrowed gaps in apparel production value chain, bench marking international best practices from the selection of quality raw materials, trendy vogue design, standard international sizing to fit customer preferences, Pattern drafting design, Lay outing, marking, and cutting materials, assembling and finishing suit design and trouser.

Although the project is already exists in the local market produce by the local industries, still most of the local citizen are patronizing imported apparel due to design, quality, competitive price of the product, through this project, it will provide assistance to improve apparel production and to respond the economic catastrophe in terms of job employment and to compete product to global competitiveness

Whereas one of the core value and significance of producing this project is the affordability of the MSE's to start a business and to improve Cultural Lined Men's Suit and Trouser as primary base benchmarking international practices in apparel production. In this manner, the standard costing of materials will be computed as well as the labor cost so as to get the exact amount of each items and must implement uniform pricing in the local traders, sewers, and operators for Micro and small enterprise to which consumers are provided quality men's suit and trouser at a cheaper price.

Key words:-Apparel, Micro and small enterprise, local fashion, value chain, bench marking international sizing

Objective of the project

General objective:

This project aims to address skill gaps and enhance 100% copying technology in Apparel Fashion Designing and Technology enhancement, bench marking industries with good international practice in produce Sew Design Prototype of producing and preparing lined men's coat and trouser which could be transferred/ used /to SMEs.

Specific objectives:

Specifically, it attempts to:

1. To produce quality, marketable and saleable products
2. To fill gaps of the trainers
3. To support MSEs in producing quality garments which are locally and globally competitive
4. To make MSEs workers be competent in the local and international market
5. To maximize raw material utilization and application of Kaizen

Product Description:

The Cultural Lined Men's Suit designed with two front flap, chest and three secret lining pockets, overlap slits at the back and sleeves for flexibility and comfort., Straight cut Men's Trouser with two single welt back and two slide pockets to match the lined men's suit which is categorized as a formal wear in all special occasions executive businesses attire like Wedding, graduation and other social gatherings

Product Photo: Men’s Suit with Cultural Fabric Design (Sabah Fabric)

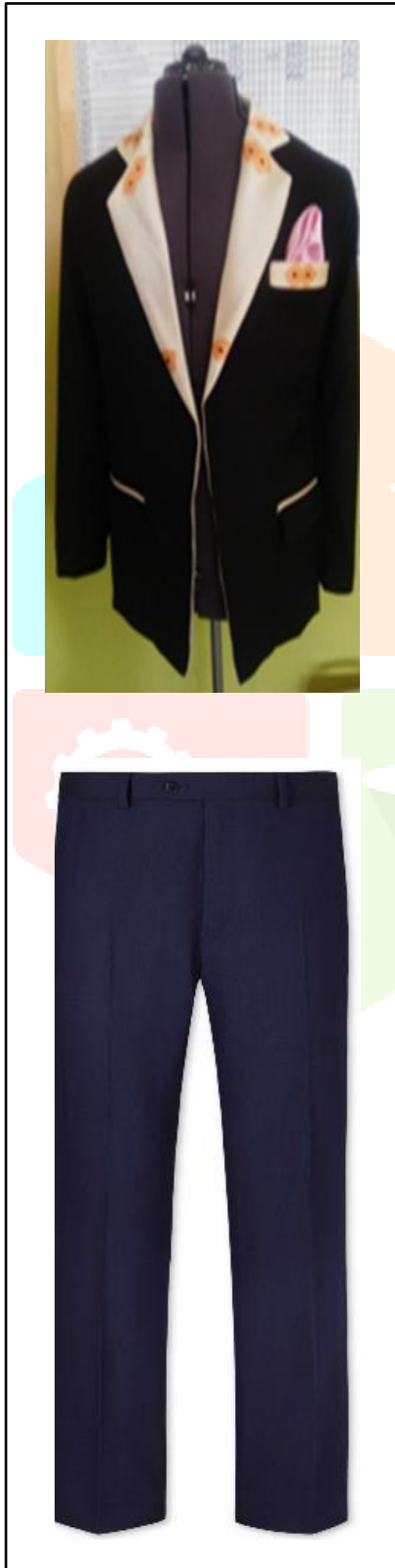

Technology:

Techno ware: Modern Industrial machine, Pattern Paper, Professional Working Bench, Vacuum Ironing Board, Adjustable Iron, Steam Press Machine, Hanger, Cutting Machine, Padding
Human-ware: Design and Reading Skill, Pattern Making Skill, Sewing Skill (Speed), Finishing (Skill)Operating Specialized Industrial Machine
Info ware: Layout Manual, Production Procedure Manual, Advertising Manual, International Garment Sizing
Orga ware: Shop Layout- Mass production operation

Technical competence:

Apparel Fashion Designing Technology and Supervision Production L4

- Use template to draw sketches
- Mensuration/ Standard International measurement
- Job estimate
- Draft basic/ block and final pattern
- Lay out, Mark and cut
- Practice OHS
- Prepare work station tools and equipment
- Prepare garment pieces
- Assemble garment component
- Complete work

Integrated competencies: Draw and interpret basic sketch, Prepare design concept for simple garment, Take body measurements, Perform hand stitching, Carryout and analyze body measurements, Prepare Trade Drawings for Fashion Design, Interpret Pattern and Apply Pattern Information, Develop pattern from a block using basic pattern making principles Analyze fit model, Measure and Cut Commercially Tailored Garment, Cut Simple Fabric and Lays, Prepare sewing machine, Perform industrial sewing machine minor servicing, Operate specialized industrial machine, Perform Garment Finishing, Bundle and label cut fabrics, Mark lay-up and cut complicated fabrics and lays, Cut and Sew

Kaizen:

Workshop lay out prepared

Entrepreneurship:

Reshaping of the business study

Men's Suit Front



Men's Suit Back



Men's Suit Sleeve



Men's trouser front



Men's trouser side



Men's trouser back



Operation:

Procedure the Product (See TTLM/Manuals for Details)

1. Prepare materials
2. Draw or sketch the design required
3. Take Body Measurement
4. Draft the block pattern, design & draft final pattern
5. Lay mark & cut the fabric
6. Prepare the Machine
7. Sew garment parts with special attachment/folders
8. Assemble Garment parts
9. Apply finishing touches.
10. Fitting
11. Alteration
12. Final Inspection and packaging.

LIST OF TOOLS, EQUIPMENT AND MATERIALS TO PRODUCE THE PRODUCT (S)

No.	Description	Unit	Quantity
A.	Materials and Tools <i>Note: (Good for one person)</i>		
1	Pencil	pc	1
2	Pencil sharpener	pc	1
3	Tape measure	pc	1
4	Calculator	pc	1
5	French Curve	pc	1
6	Straight Rule /50cm/ Transparent	pc	1
7	Triangle, 45 x 45	pc	1
8	Hip curve	pc	1
9	Pattern paper (soft)	sheet s	10
10	Pattern paper (hard)	sheet s	10
11	Pattern notcher	pc	1
12	Tracing wheel	pc	1
13	Scissor (for paper use)	pair	1
14	Fabric Shears (plastic handle)	pair	1
15	Seam ripper	pc	1
16	Trimmer/cutter	pc	1
17	Dressmaking tracing paper	pack	1
B. Equipment:			
1	Lock stitch machine (straight sewing)	unit	1
2	Over lock machine 3,4,5	unit	1

3	Drafting table	unit	1
4	Button hole stitch machine	unit	1
5	Button-sew machine	unit	1
6	Bar tack machine	unit	1

Bill of Materials for Suit with Cultural Design

No.	Materials (Description)	Quantity/ Unit	Unit Cost (in Birr)	Total Cost (in Birr)
1	Wool Fabric	3 meters	180.00	540.00
2.	Cultural Fabric with Design	½ meter	150.00	75.00
2	Hair Cloth	1 meter	75.00	75.00
3	Nylon Lining	2 meters	35.00	70.00
4	Interlining (fusible) bonded	1.5 meters	40.00	60.00
5	Interlining (fusible) woven	1.5 meters	40.00	60.00
6	Thread	1 spool	5.00	5.00
7	Buttons, sew-through, 4-holes (coat front)	2 cm. diameter/3 pcs.	2.00	6.00
8	Buttons, sew-through, 4-holes (coat sleeve)	1.5 cm. diameter/9 pcs	1.00	9.00
9	Buttons, sew-through, flat 2-holes (pants)	2 cm. diameter/ 2 pcs	2.00	4.00
10	Buttons, sew-through, flat 2-holes (pants)	1.5 diameter/ 1 pcs	1.00	1.00
11	Waistband lining	1 meter	30.00	30.00
12	Zipper (metal), 8 inches	1 pc	5.00	5.00
13	Wool pads, 2 cm thickness	1 pair	25.00	25.00
			Total	965.00

Note: - This bill is for a single (one) project

Project Cost Analysis:

1. Materials Cost ----- 965.00 RMB/yuan
2. Labor ----- 289.00 RMB/yuan
Cost ----- 96.00 RMB/yuan
3. Utility -----
Cost -----
4. Machine Depreciation ----- 48.00 RMB/yuan
5. Production Cost ----- 1,399.00 RMB/yuan
6. Mark-up ----- 419.70 RMB/yuan
price ----- 1,818.70 RMB/yuan
7. Selling -----
Price -----

Domestic Price-----2,300.00 RMB/yuan

Selling Price-----1,818.70 RMB/yuan

In comparison with the existing market price of the suit 2300.00 yuan , initially the project price is lower 21% Production cost will be less for high volume order of materials resulting to lower selling price.

Learners Guides

**LINED MEN'S SUIT WITH CULTURAL
DESIGN**

GARMENT SPECIFICATION SHEETS

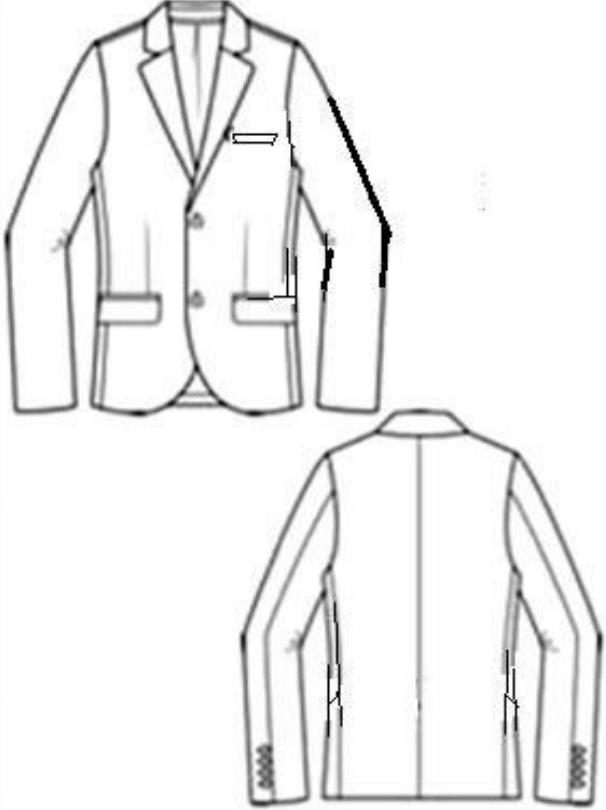
LINED MEN'S COAT				
Specification Sheet				
Measurements	Actual	Ease	Final	SKETCH
Shoulder width				
Chest circumference***				
Back waist length				
Front chest				
Shoulder blades width				
Jacket length				
Coat length				
Sleeve length				
Wrist circumference***				
				Trims
				3 pcs ,2 cm, 4-hole sew through buttons (CF)
				9 pcs, 1.5 cm, 4-hole sew through buttons (Sleeves)
				Colour/s
				<div style="border: 1px solid black; width: 150px; height: 40px; margin: 0 auto;"></div>
				Interlining
				Haircloth
				Fusible for suit (Black)
				Wool pads
				2 pcs, 2 cm thick

Comments	***TOTAL CIRCUMFERENCE MEASUREMENT
----------	---------------------------------------

LINED MEN'S

COAT DETAILED

SKETCH

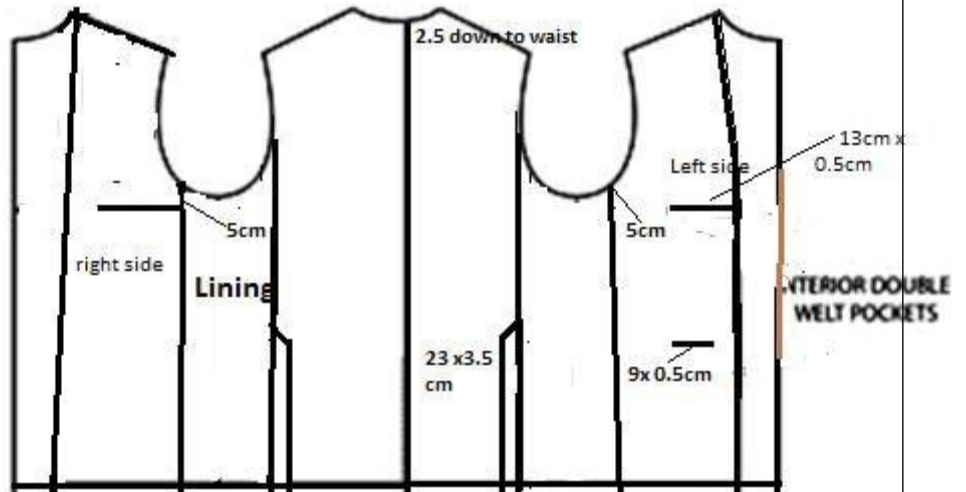
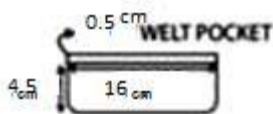
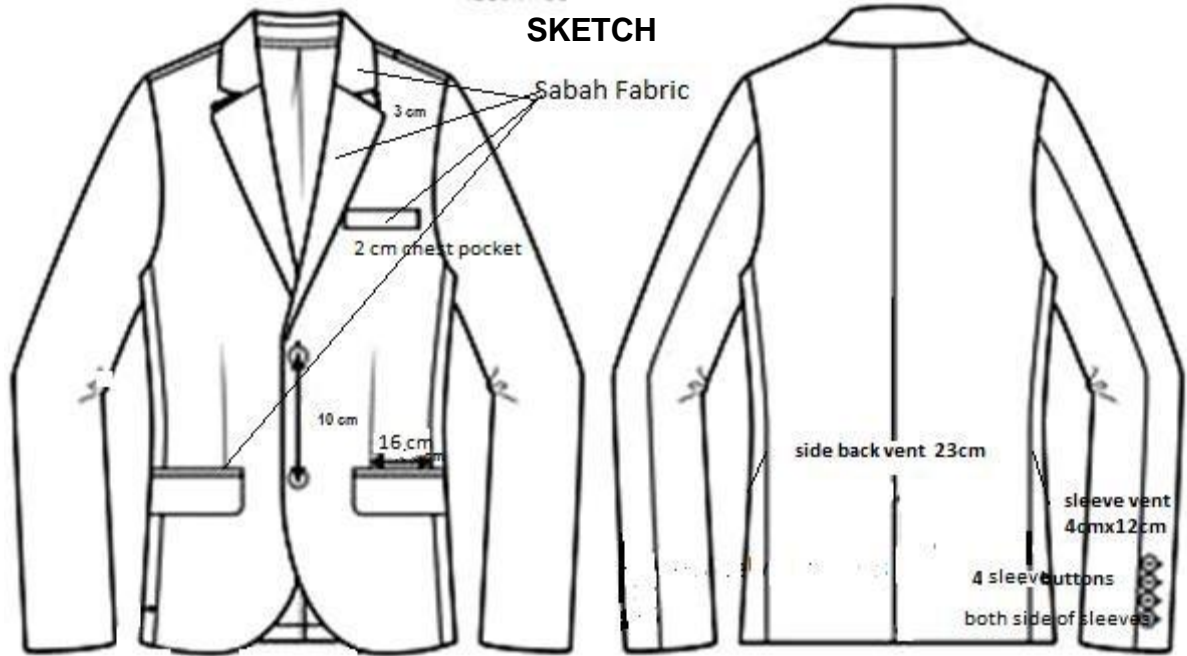

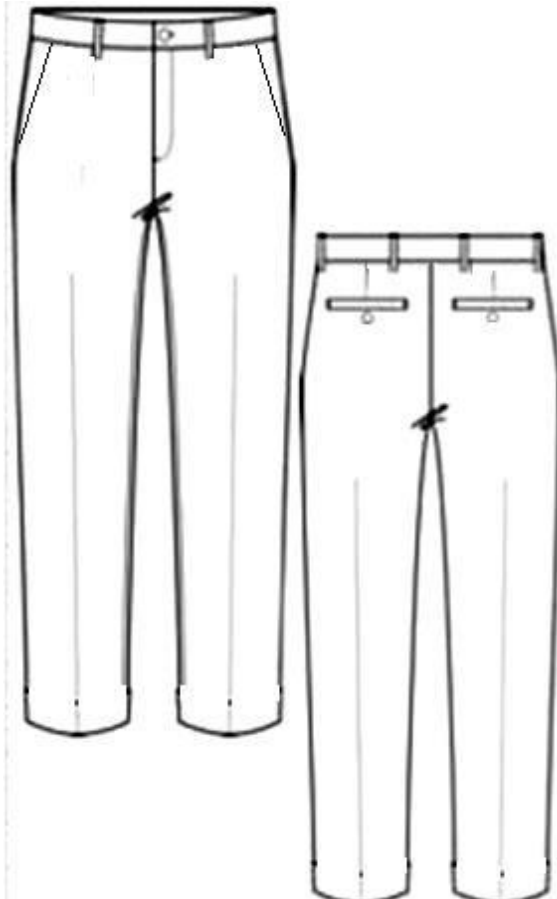
LINED MEN'S TROUSERS				
Specification Sheet				
Measurements	Actual	Ease	Final	SKETCH
Waist circumference***				
Hip circumference***				
Pants length				
Crotch length				
Thigh circumference***				
Bottom circumference***				
				Color <div style="border: 1px solid black; width: 100px; height: 40px; margin-left: auto; margin-right: auto;"></div>
Comments	***TOTAL CIRCUMFERENCE MEASUREMENT			

**LINED MEN'S
TROUSERS
DETAILED SKETCH**

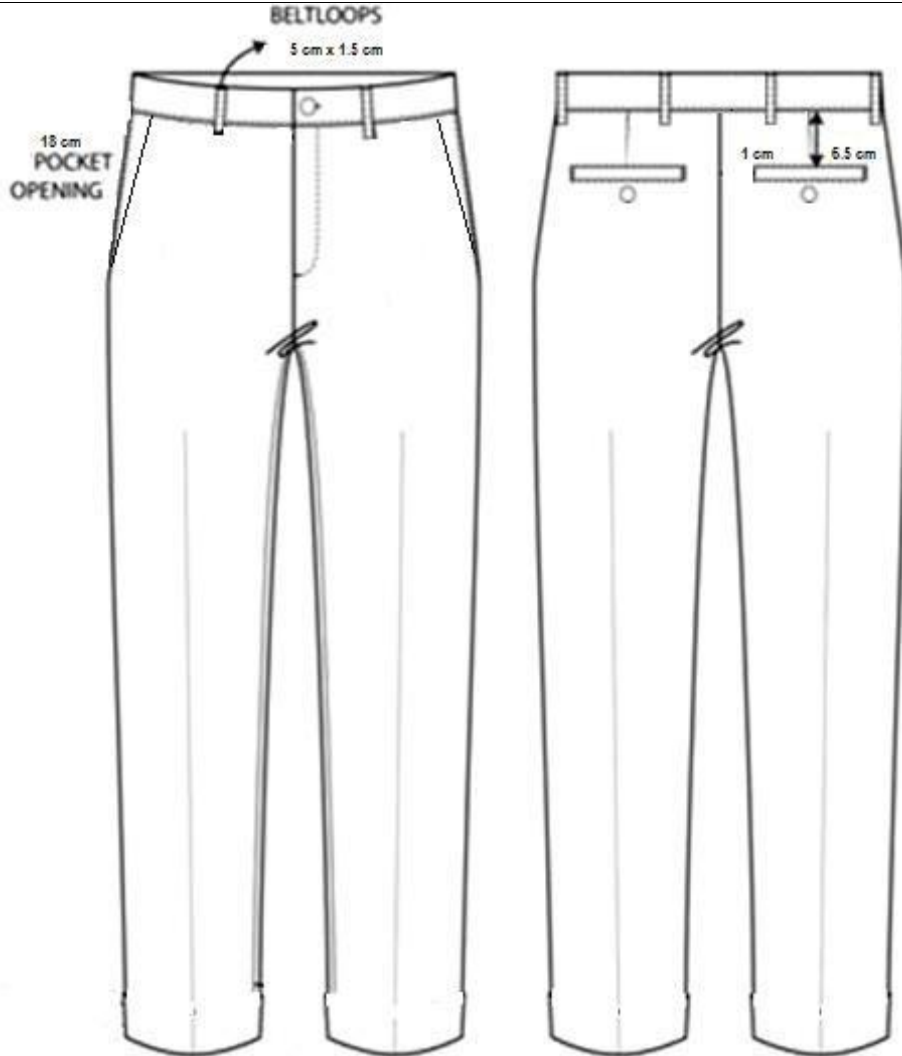

Operation Sheet-1

TAKING BODY MEASUREMENTS

PURPOSE:

Accurate body measurements help produce correct patterns and well-fitted garments. Time in constructing a garment is saved if body measurements are taken accurately.

CONDITIONS/SITUATIONS:

Use tape measure that does not stretch.

Let the subject stand in a relaxed and upright position.

Bulky garments, sweaters, jackets and belts should be removed before taking your measurements, as they tend to distort the accuracy of the measurement process

MATERIALS, TOOLS AND EQUIPMENT:

- Tape measure
- Pencil
- Record book

PROCEDURE:

There are several parts of the body to be measured. These are taken in

- Horizontal measurement
- Vertical measurement
- Circumferential (Girth) measurement

1. Full Chest / Chest Circumference

- Measure around the chest and body at its fullest part (typically right under the armpits and shoulder blades, right across the nipples).
- Hold the tape against the body tight enough so that it does not slip down, but not so tight that it restricts breathing. It should be "snug".
- Make sure the tape is horizontal and the person's arms are by their side; then take a normal breath and measure.
- Do not puff out your chest
- Double check this measurement.
- My Full Chest is ____ . ____ inches



2. Full Shoulder Width

- Measure from the end of the right shoulder to the end of the left shoulder.
- We define the “End of the Shoulder” as where the horizontal plane of the shoulder intersects the vertical plane of the arm (see illustration).
- Double check measurement.
- My Full Shoulder Width is _____ inches.



3. Sleeve Length

- Measure from the end of the shoulder to the “Pinch” of the right hand.
- The “Pinch” of the hand is found where the base of the thumb and the base of the index finger intersect (approximately 1 inch above the index finger knuckle).
- Double check this measurement.
- Right Sleeve is _____ inches.



4. Bicep

- Measure around the fullest part of the bicep with the arms by your side.
- You need only measure one side.
- My Bicep is _____ inches



5. Waist / Stomach

- Measure around the fullest part of the waist/stomach or right below your bottom ribs, whichever is greater.
- Waist is _____ inches.



6. Hips

- Measure around the fullest part of your hips and buttocks.
- My Hips/Seat is _____ inches.

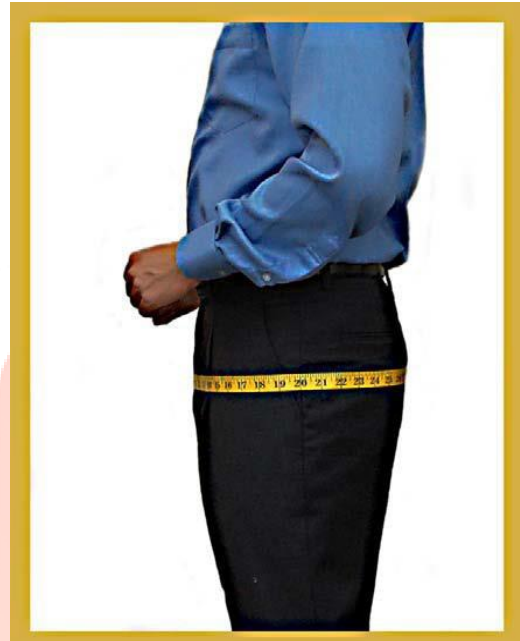
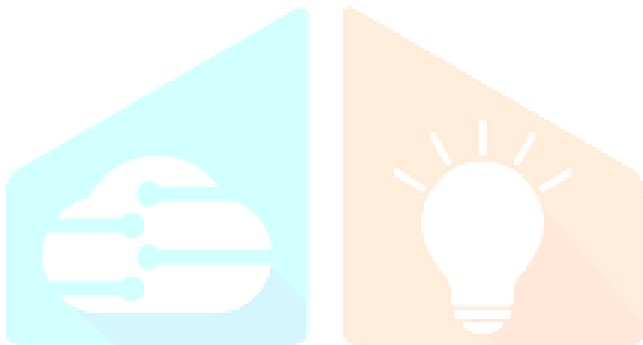

7. Front Jacket Length

- Measure straight down the front from the base of the neck (right or left side) to the point level with your thumb knuckle.
- My Front Jacket Length is _____ inches.



8.. Front Chest Width

- With the person's arms by their side, measure across the front of the chest.
- Start at the front of the right armpit, continue measuring across the nipples, and then stop at the front of the left armpit. Do not measure under the arms.
- My Front Chest Width is _____ inches.



9. Back Width

- With the person's arms by their side, measure across the back.
- Start at the back of the right armpit, continue measuring across the shoulder blades, and then stop at the back of the left armpit. Do not measure under the arms.
- This is the back part of the full chest measurement we took in step 2.
- My Back Width is _____ inches.



10. Shoulder Width Measure from the end of the right shoulder to the base of the right side of the neck.

➤ We define the “Side of the Neck” as the point at which the vertical plane of the neck intersects the horizontal plane of the shoulder.

➤ My Shoulder Width is _____ inches.

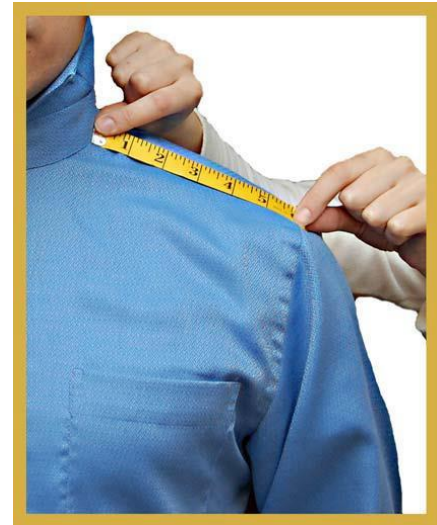

11. Back Waist Length

➤ Measure from the base of the back of the neck to the top of the pants waistband area.

➤ Back WaistLength is _____ inches.



12. Trouser Waist

- Measure around your waist at the level where you would normally wear your pants belt.
- With the tape measure snug around your waist, relax, and take the measurement.
- Don't be alarmed if this measurement seems larger than expected; off-the-rack pants are normally labeled as being smaller than what they really are.
- Trouser Waist is _____ Inches.



13. Trouser's Out seam

- Measure from the top of your pant's waistband to the floor along the outside of your leg.
- Make sure the tape is tight, that you are standing straight, and then measure. No shoes please!
- Double check this measurement.
- Trouser's Outseam is _____ inches.



14. Trousers Inseam

- Measure from the lowest part of your crotch area to the floor.
- Make sure the tape is tight along the inside of your leg, that you are standing straight, and then measure. No shoes please!
- Trousers Inseam is _____ Inches.



15. Crotch

- Measure from the front top of the pants waistband to the back top of the pants waistband.
- Make sure not to take this measurement too tight.
- Crotch Measurement is _____ Inches.



16. Thigh

- Measure around your thigh at its widest point.
- You need measure only one side.
- My Thigh is _____ Inches.



17. Knee

- Measure around your knee at its widest point.
- You need only measure one side.
- My Knee is _____ inches



18. Bottom Circumference

- Measure around your heel and in-step providing ease for wearing.
- My bottom circumference is _____ inches



Operation Sheet- 2**Drafting the Basic Jacket Sloper**

PURPOSE: Draft patterns accurately

EQUIPMENT TOOLS AND MATERIALS:

- Cutting/drafting table
- Eraser
- Pencil
- Drafting tools
- Tape measure
- Pattern papers
- Tools for pattern drafting

CONDITIONS OR SITUATIONS FOR THE OPERATIONS:

Given are the necessary tools, materials and equipment, you are required to draft the **basic jacket sloper patterns** according to specification within the specified time.

PROCEDURE:

1. Prepare working area
2. Check measurement specifications.
3. Draft patterns using the obtained measurement according to the standard procedure.
4. Mark/ label patterns.
5. Check label locations.
6. Cut patterns.

PRECAUTIONS:

1. Draft patterns according to specifications
2. Practice OHS.
3. Use proper tools in drafting patterns.

QUALITY CRITERIA:

1. Patterns are prepared accurately.
2. Markings are in accordance to given specification.
3. Labels are visible and in accordance to specifications.
4. Final patterns are in accordance to specification

Drafting the Basic Jacket Sloper

In order to draft the basic jacket sloper, the following measurements are needed:

1/2 chest circumference + 3" (for ease center front to center back) 1/2 front chest. 1/2 shoulder blade SEE SIZE CHART

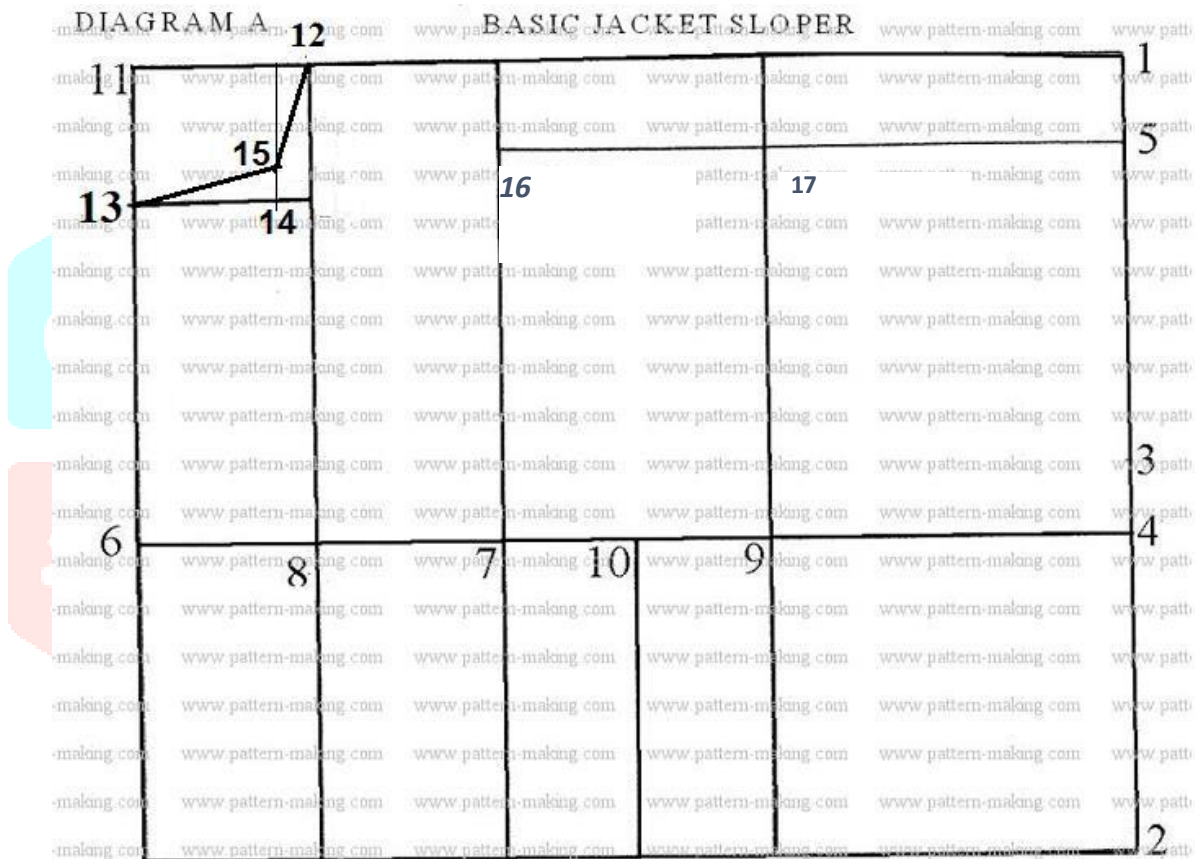

Procedure :

- 1 = Starting point
- 1 to 2 = back waist length (center back)
- 2 = waist
- 3 = midpoint of 1 to 2
- 3 To 4 = 1 3/4" (4.45 cm) down ward
- 4 = chest line
- 1 to 5 = measure 1 to 4 and divide into 5 minus 1/2"(1.25 cm)
- 5 = shoulder guideline

Square out from 1, 5, 4, and 2 toward left

4 to 6 = 1/2 chest circumference + 2" (5 cm.) for ease

6 to 7 = 1/2 front chest + 3/8" (1.0 cm) inward

8 = midpoint of 6 to 7

4 to 9 = 1/2 shoulder blade less 1/4" (0.6 cm)

10 = midpoint of 9 to 7 to establish side seam



Square up and down from 6 to establish center

front Square up and down from 8, 7, and 9

Square down from 10 to waist

11 = intersection of line 6 and line 1

12 = corner point of line 8 and line 11

11 to 13 = measure 11 to 12 less $\frac{3}{4}$ " (2.0 cm)

Square off 12 to 14

13 to 14 = 3 inches (7.5 cm)

12 to 15 = 2 1/8 inches (5.5 cm), measured from 12

diagonally. Connect 12 to 15 with straight line

Connect 15 to 13 with straight line

16 corner point of line 7 and line 5

17 corner point of line 9 and line 5

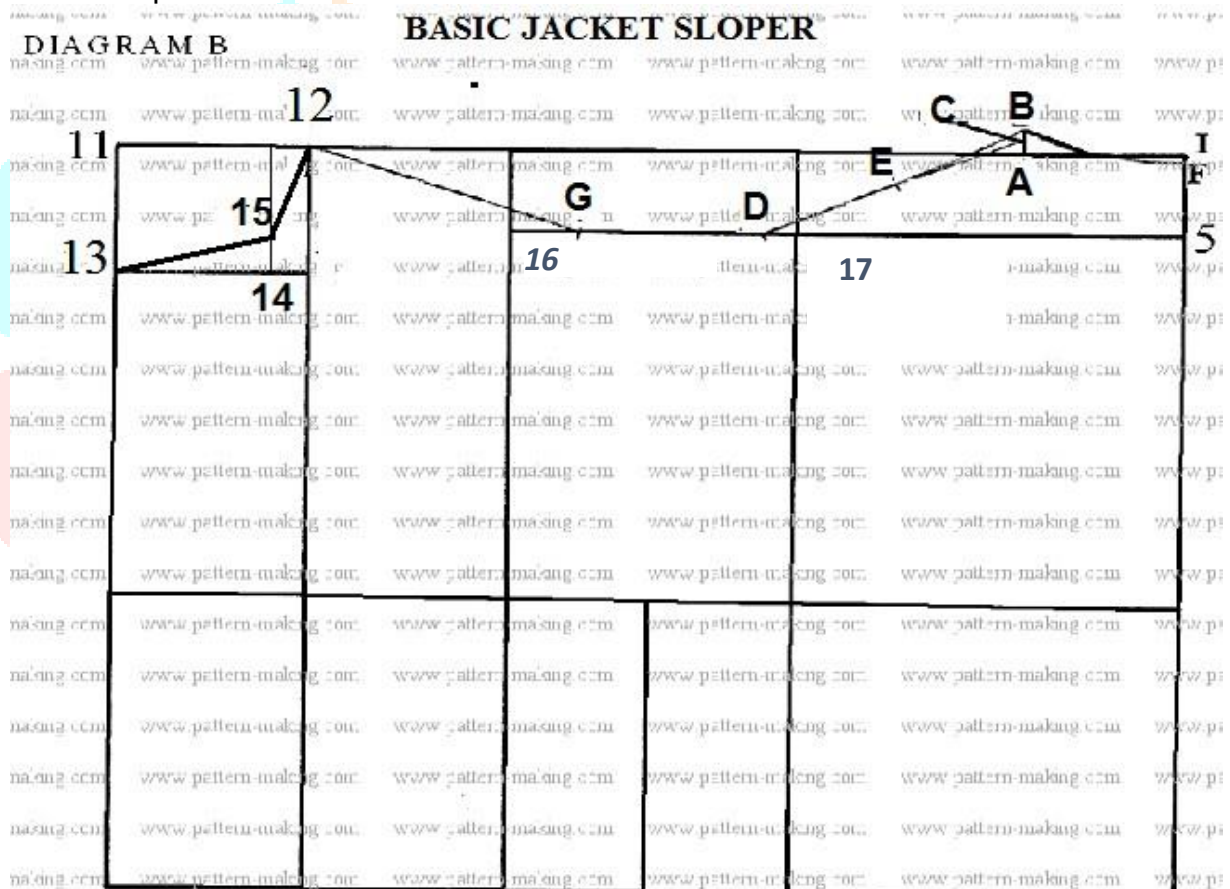

BACK PART

1 to A = measure 11 to 12 less $\frac{5}{8}$ " (1.5 cm)

A to B = Measure 1 to A Divide by 4 less upward for back neck

Shape back neck measurement

C = $\frac{1}{2}$ A to B

C to D = shoulder length less $\frac{1}{8}$ " (0.3 cm)

Connect C to D with straight line as a guide

E = 1/2 C to D

Measure .5cm, connect D to B, and with light curve on back shoulder

1 to F = 1/8" (0.3) downward Connect B to F with curve ruler to finish back neckline



FRONT PART

12 to G = measure B to D less $\frac{3}{8}$ " (1.0 cm) to establish front shoulder width
Connect 12 to G with straight line

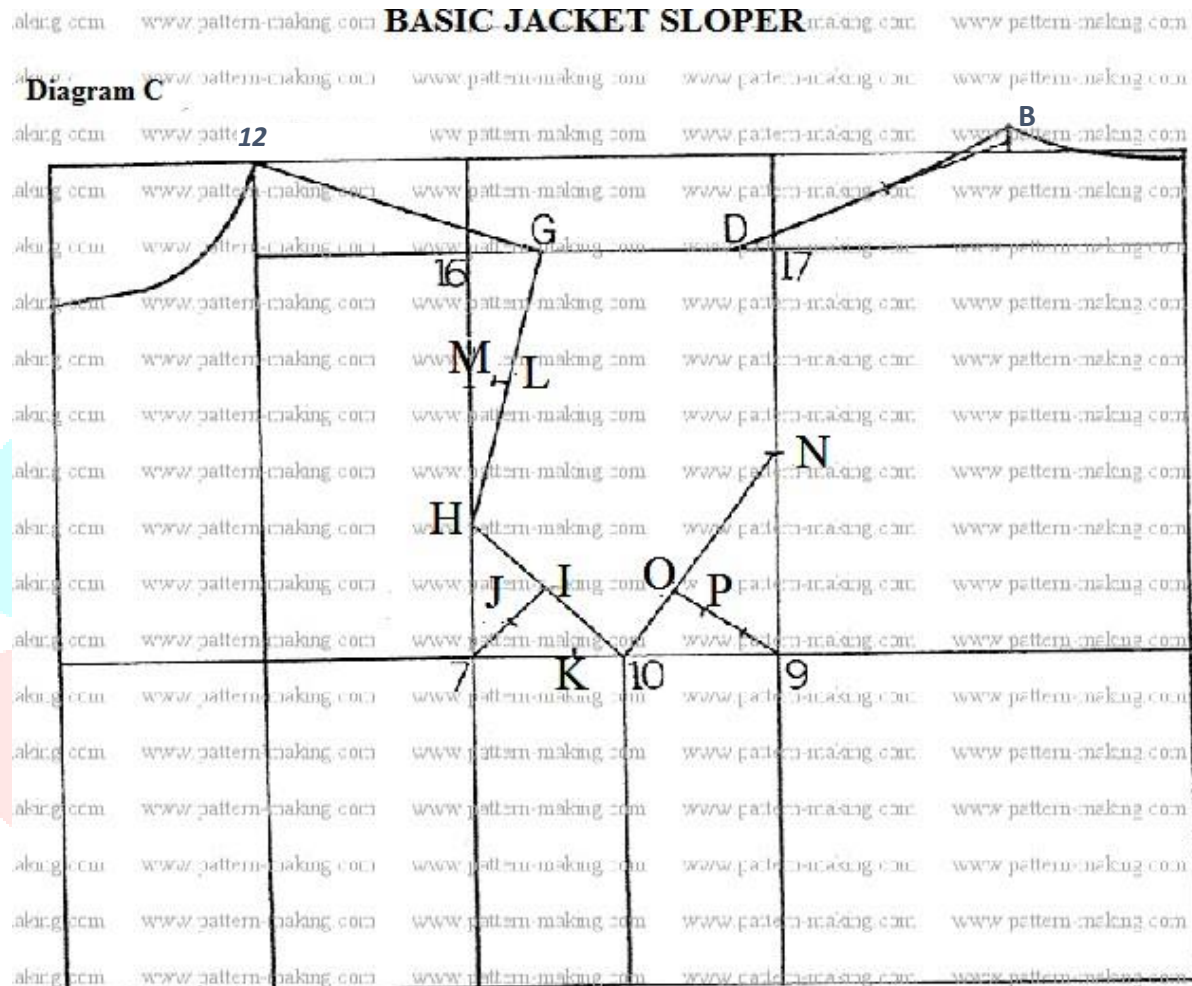
**Front armhole Preparation:**

H to G = measure 16 to 7 , divide the line by 3
Connect H to 10 , then connect H to G
To locate I square off along the line between H and 10 to 7
J = midpoint of I to 7
K = 1" (2.5cm) from 10
L = midpoint of G to H
L to M = $\frac{1}{4}$ " (0.6 cm) inward

Back armhole Preparation:

N = $\frac{1}{2}$ of 17 to 9

Connect N to 10



To locate P, square off along line between N and 10 to 9
 O to P = measure line O to 9, and divide by 3

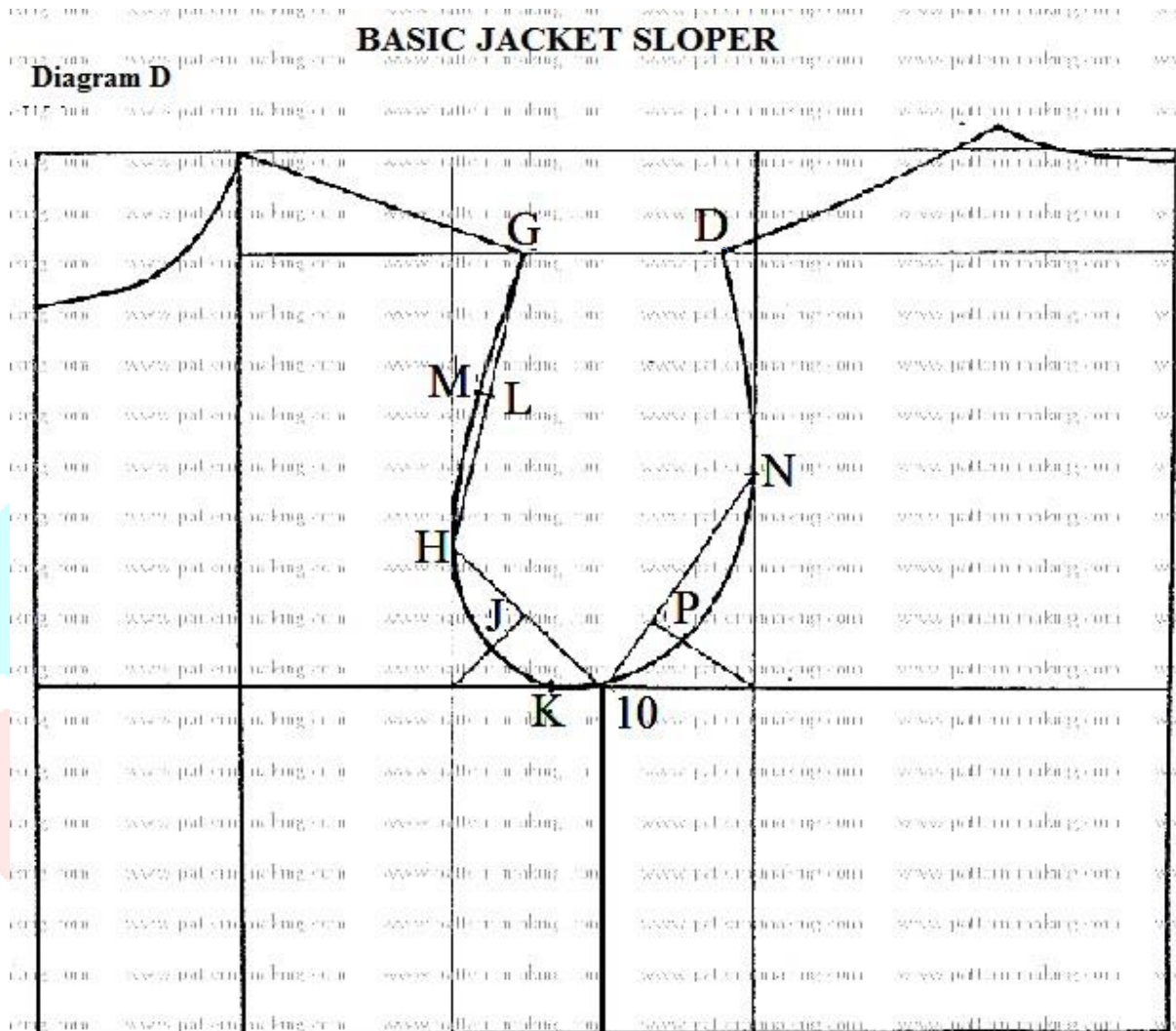

Completion of armhole

- Connect G to M to H with slight curve ruler
- Connect H , J , K , 10 to finish front armhole
- Connect D , N , P ,10 with light curve to finish back armhole

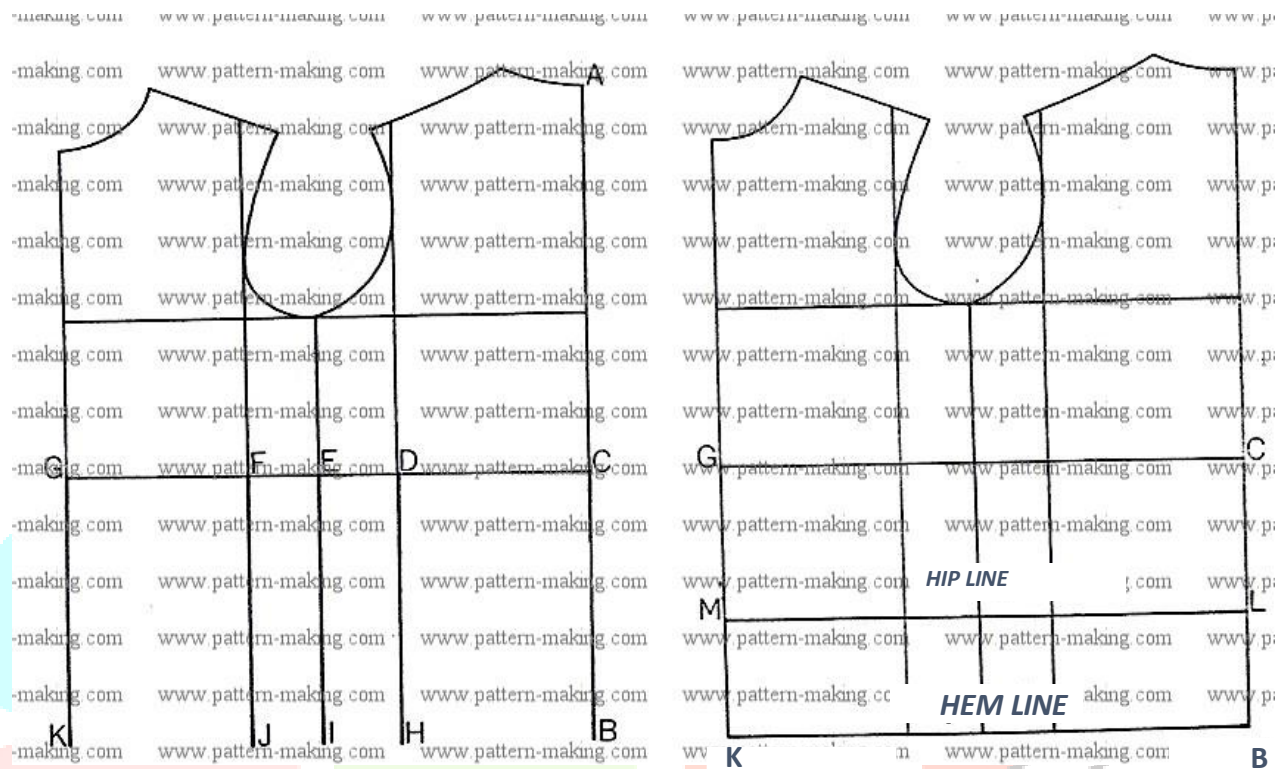

A to B = jacket length

C is at waistline

Square off from D to H, E to I, F to J, and G to K.

C to L = 8"

G to M = 8"

Connect L to M to finish hip line

Connect B to K to finish hemline

Operation Sheet-3	Drafting the Men's Coat
--------------------------	--------------------------------

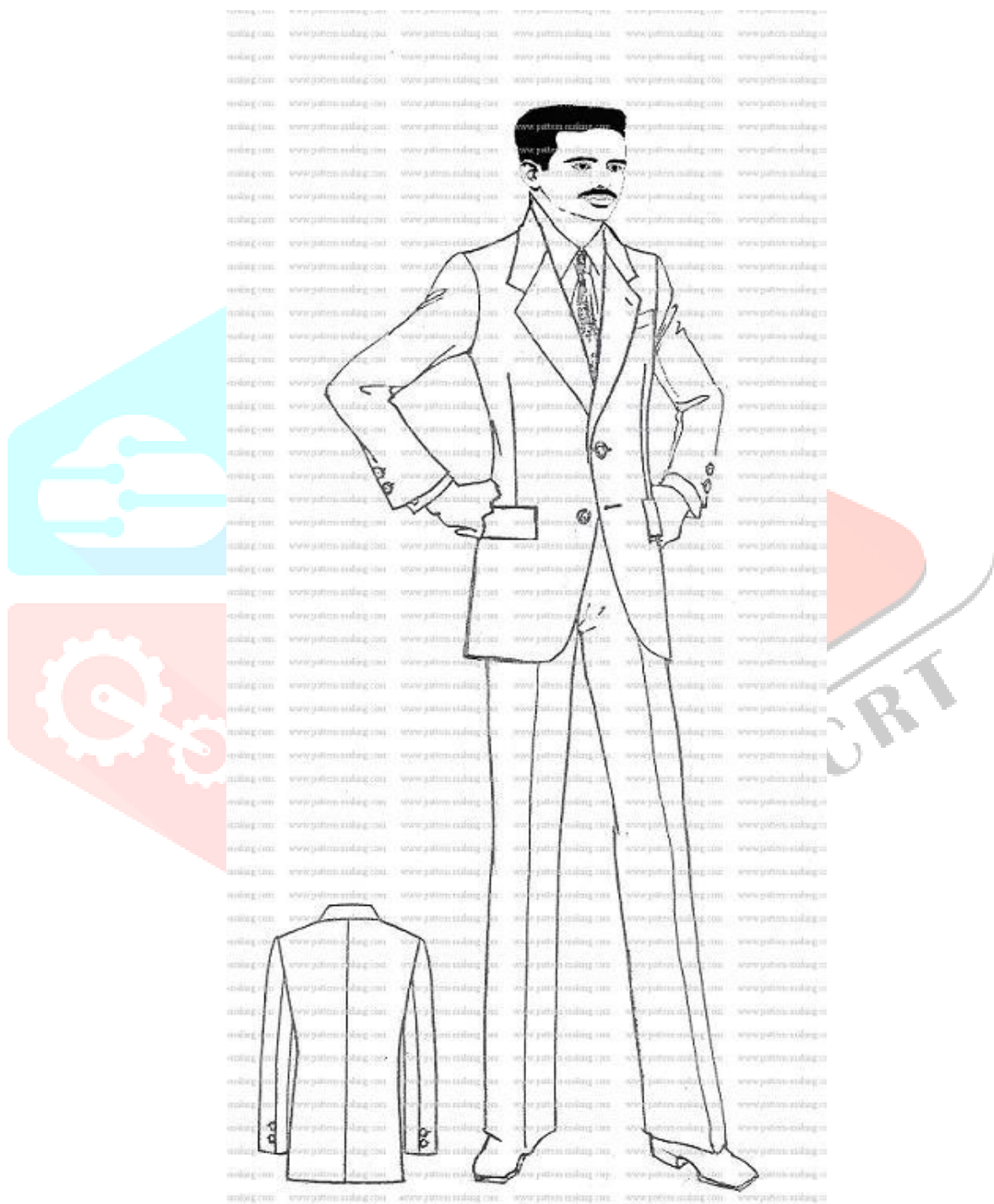

Outline your jacket sloper with full jacket length

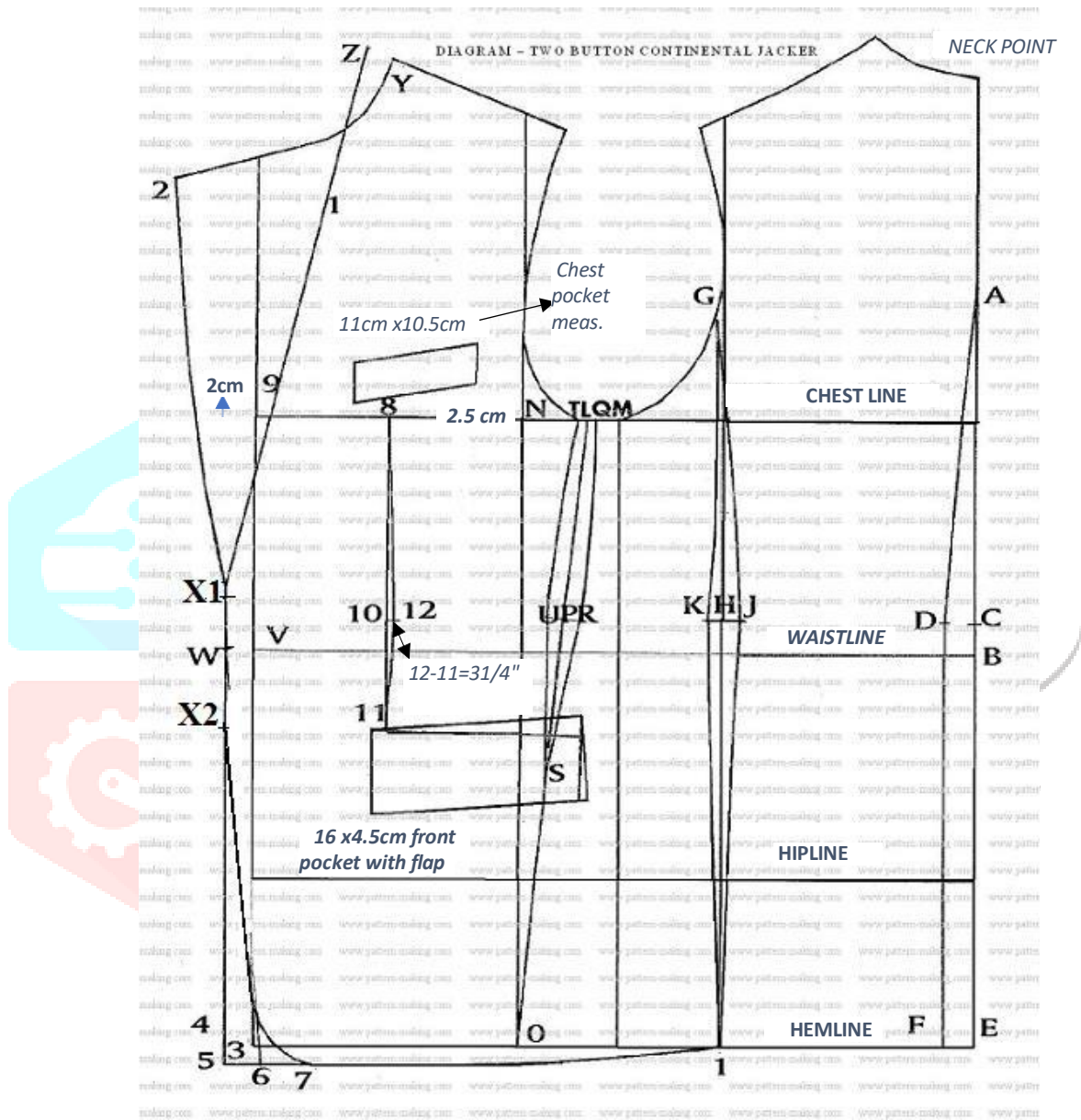

BACK PANEL

A = midpoint neck to chest line

B to C = 1" (2.5 cm) upward

C to D = 1" (2.5 cm) inward

E to F = 1" (2.5 cm) inward

Connect A to D and D to F with a straight line to finish center back

G = 3" (7.5 cm) above chest line upward in line with armhole curve

H = 1" (2.5 cm) above waistline

H to J = 1/2" (1.25 cm.)

Connect G to J with hip curve ruler

Connect J to I with straight line to finish side back panel

SIDE PANEL

H to K = 1/2" (1.25 cm.)

Connect G to K with hip curve ruler

Connect K to I with straight line

L = measure M to N and divide by 3 Connect L to O as guideline

P = 1" (2.5 cm) above waistline

L to Q = 1/4" (0.6

cm) **P to R** = 1/2"

(1.25 cm) **P to S** =

3 3/4" (9.5 cm)

Connect Q to R with hip curve ruler

Connect R to S with hip curve ruler to finish side panel

FRONT PANEL

L to T = 1/4" (0.6 cm)

P to U = 1/2" (1.25 cm)

Connect T to U with hip curve ruler

Connect U to S with straight line to finish front dart

BUTTON EXTENSION

V to W = 3/4" (2.0 cm) for extension

W to X1 = 2" (5.0 cm)

upward **W to X2** = 2" (5.0

cm) downward **Y** = shoulder

point at neck **Y to Z** = collar

stand 1/18

Extend neckline and square off lapel width 1 to 2 according to design (7cm

lapel width) Connect 2 to X with hip curve ruler using a curve toward 2

(according to design) Corner point k is is 3

3 to 4 = 3/4" (2.0 cm) extension of buttons

4 to 5 = 1/2" (1.25 cm) downward

5 to 6 = 1 1/4" (3.25 cm) inward

Connect X2 to 6 with straight line as a guide

Connect x1 to x2 with straight line

Connect 6 to 7 with French curve according to design , shape is point 7

8 = $\frac{1}{2}$ of 9 to N

10 = 1 above waistline

10 to 11 = $3 \frac{1}{4}$ " (8.25 cm)



Connect 8 to 11 with straight line

10 to 12 = 1cm

Connect 8 to 12 with straight line

Connect 12 to 11 with straight line to finish front dart

Note: **Deeper the lines to identify the front panel side panel and back panel**

Operation Sheet- 4	Drafting the Men's Coat Notch Collar
---------------------------	---

Measurements Needed	Inches	Centimeter
Collar stand	3/4 inches	2 cm
Collar fall	2 inches	5 cm
Shift	3/8 inch	1 cm when fold the collar

Lapel design

D to E = collar stand ,1 1/8" (2.75 cm)

Connect and extend C to E to establish roll line

G to C = roll line at neck

H = Measurement of lapel position from construction line downward (9cm, 10cm)

1 = lapel width design (7cm)

cm

Square off point 1 to H for lapel width

Connect G to H as lapel width 7 cm

Connect H to C with slightly curve toward C / as design

Collar Stand

M to N = back neck measurement (Meas. Back neck)

Square from N use triangle

N to P = collar stand 3/4 (2cm)

P to O = collar fall 2 inches (5cm)

N to O = collar width (Total width of back collar)

Collar Fall

H to Q =length of Lapel notch 3.5cm inward

H to R = 3cm space of notch

Q to R = length and angle 3cm upward as collar width

S = center of R to O

Connect R to S with a straight line slightly curve

Blend in S to O curve finish collar line

Blend in at point E to finish roll line

Note: **O to P should be 90 degree**

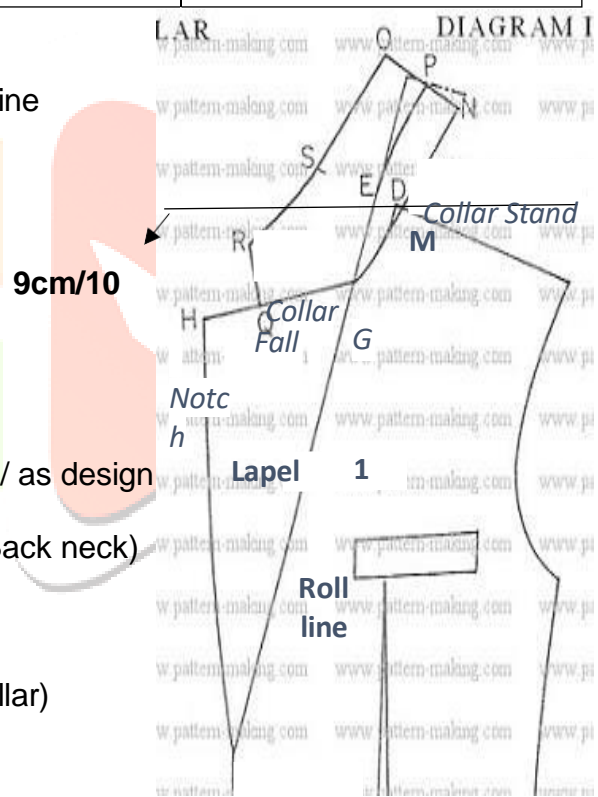

C Break point

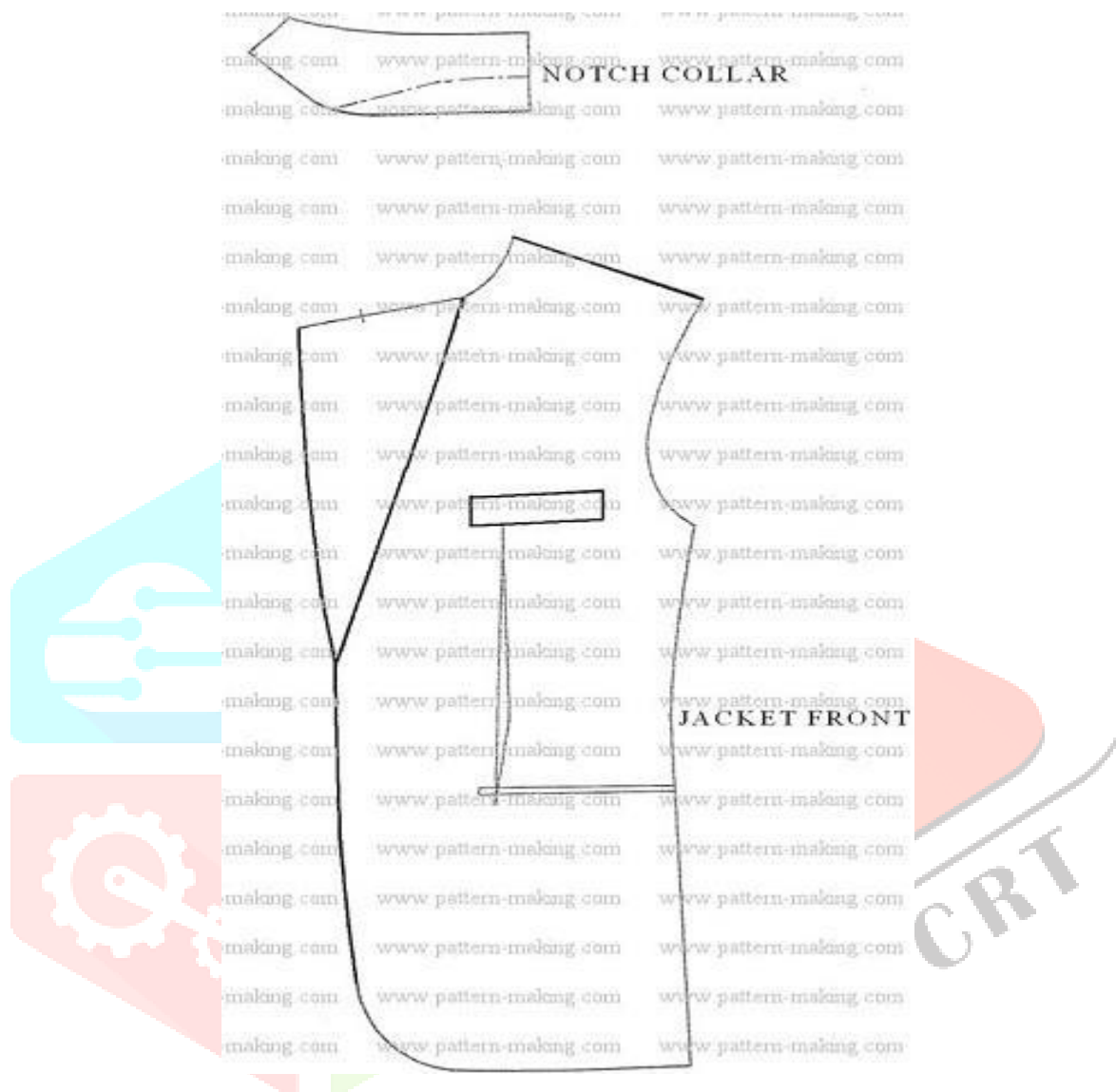

Cut the collar from the neckline of the drafted coat.

Operation Sheet 5

Drafting Men's Two-piece Sleeve

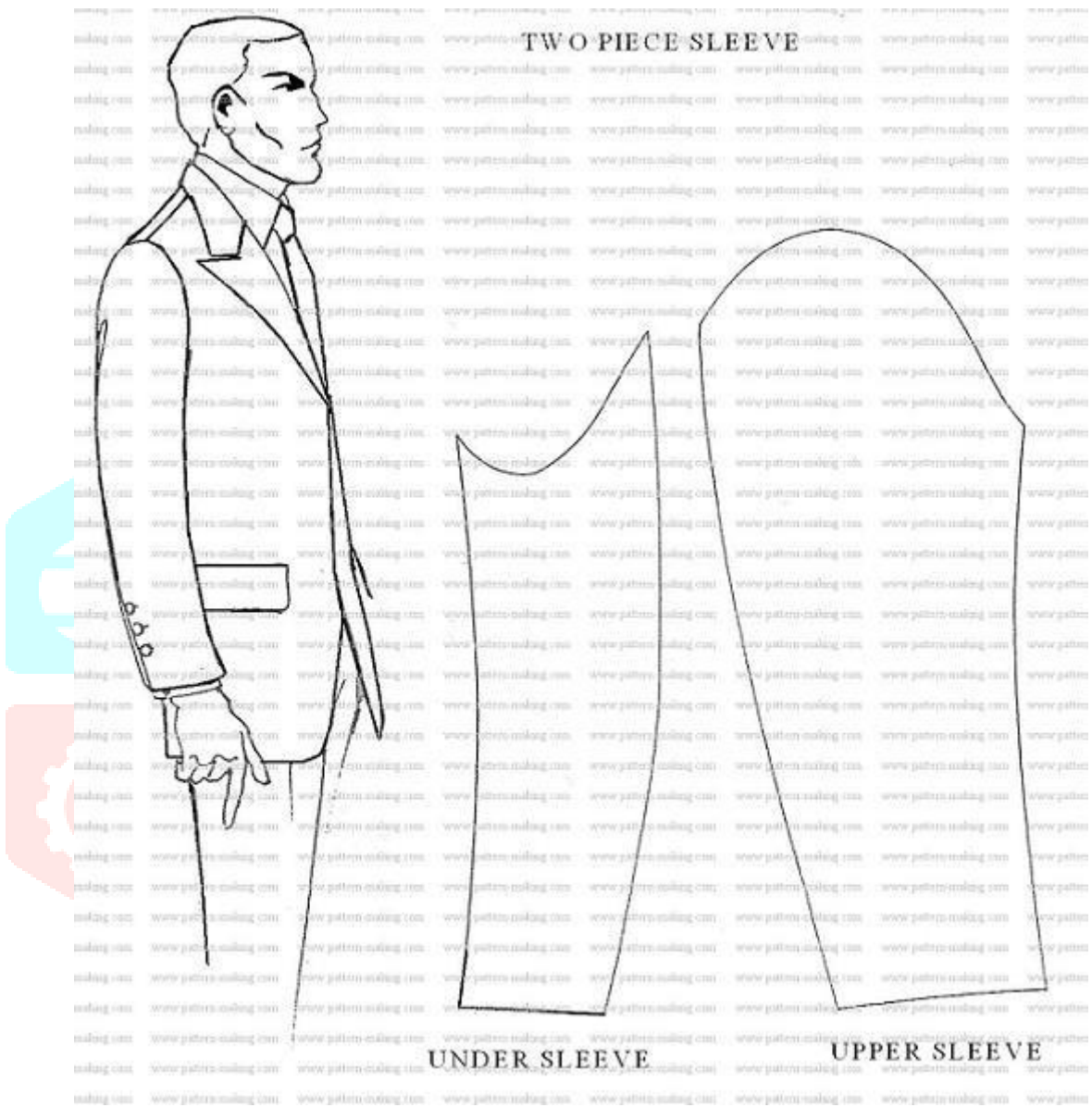

Measurements Needed:
See Standard chart measurement
 Sleeve Length
 Cap height
 Biceps

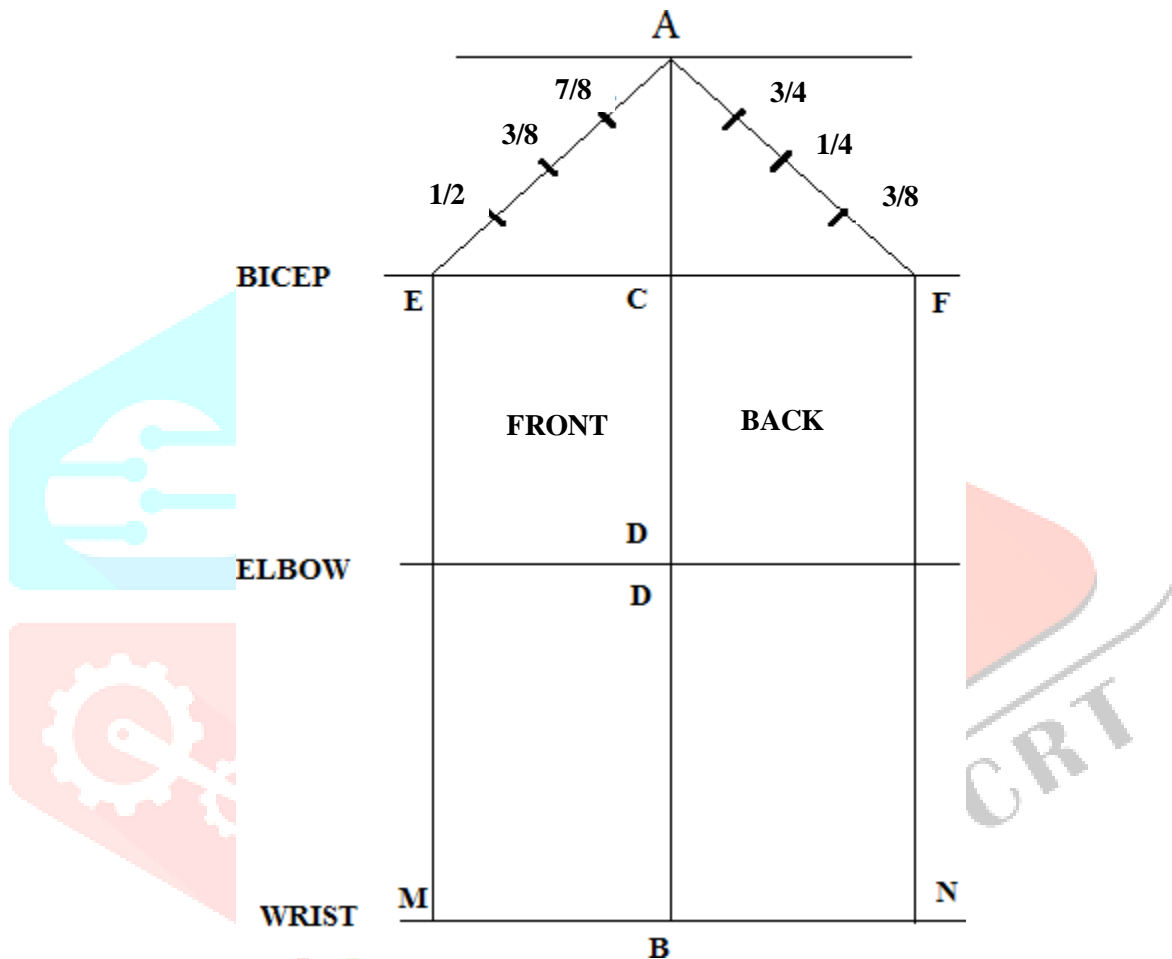

Figure 1

A – B= sleeve length. Add ½ inch (1.25 cm) and draw line to wrist

A – C= Cap height Mark on A – B line.

See sleeve size chart, apply armhole measurement.

B – D= Half B- C plus 1 inch (2.54 cm) upward Label D and square from all the marks.

C – E = ½ of biceps measurement. Personal fit use recorded biceps.

E - F= A-E

B – M= C-E

B – N= C - F

Connect M and N to E and F.

Square Lines from the following letters :

I - out 3/4"

J - 7/8"

H - out 1/4"

K - 3/8"

Between G and E in 3/8"

L - Between N-F in 1/2"

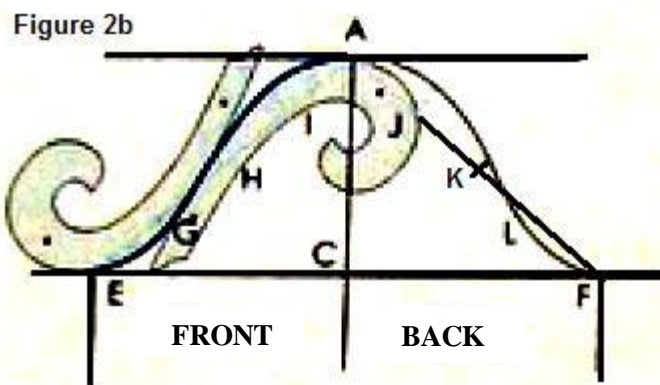
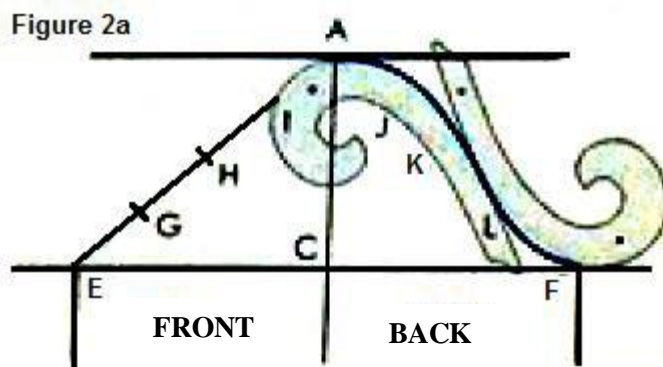

Shaping Cap

Use French curve.

Figure 2a,b

Connect A,J,K and draw line passing K

Connect F,I and blend with K line (a).

Connect A,I,H and draw line passing H.

Connect E-G and blend with H line(b)

Upper sleeve

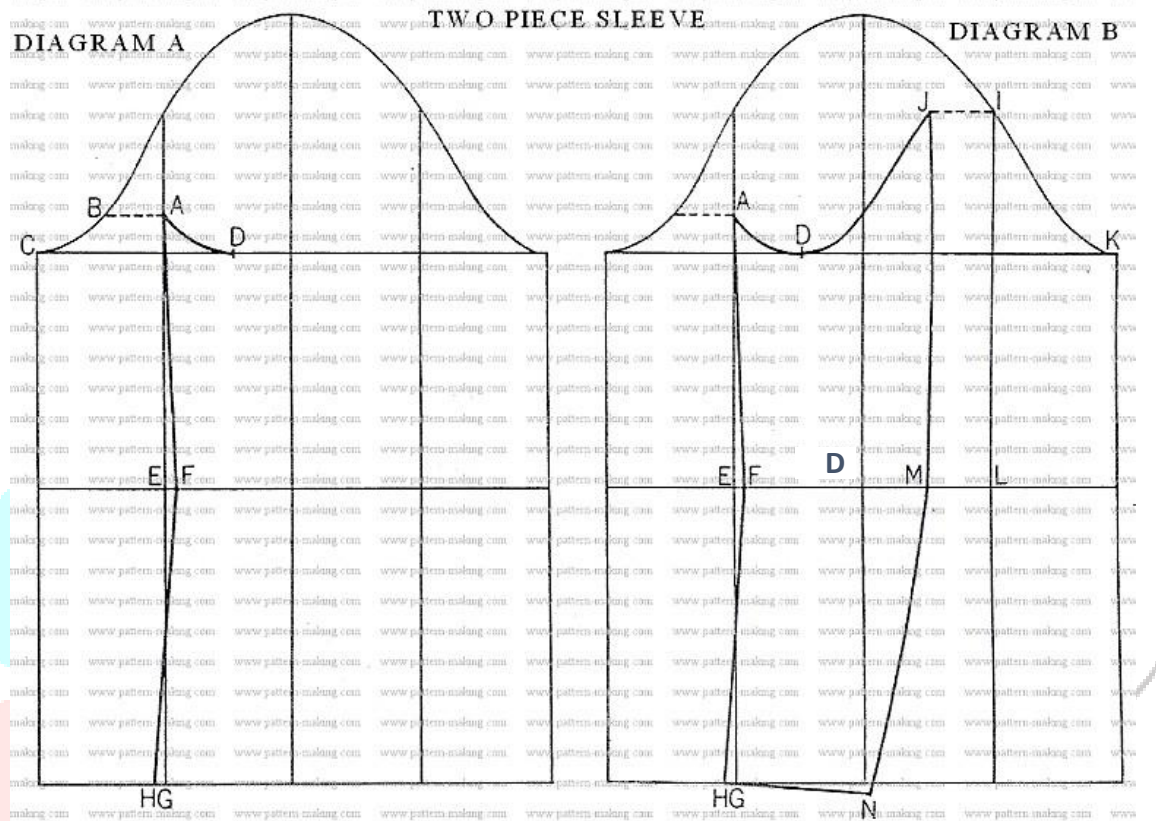

Outline sleeve sloper two piece sleeve consists of upper sleeve and under sleeve.

- On front guideline, square off from A to B for (3.5 cm)
- Transfer curve between B and C to A and D
- E to F** = $\frac{3}{8}$ (1 cm)
- H to G** = $\frac{3}{8}$ (1 cm) connect A to F and F to H to finish inseam.
- Square off top of back guideline I to J for (3.5cm)
- Transfer curve between I and K to J and D
- M** = midpoint of point D and point L
- H to N** = $\frac{1}{2}$ wrist circumference minus 1" (2.5 cm) (circumference)
- Connect J to M with shallowest part of hip curve ruler.
- Connect m to n with shallowest part of hip curve ruler to finish under sleeve

Note: the average cuff/wrist measurement is 11" – 12". this may change according to your design upper sleeve

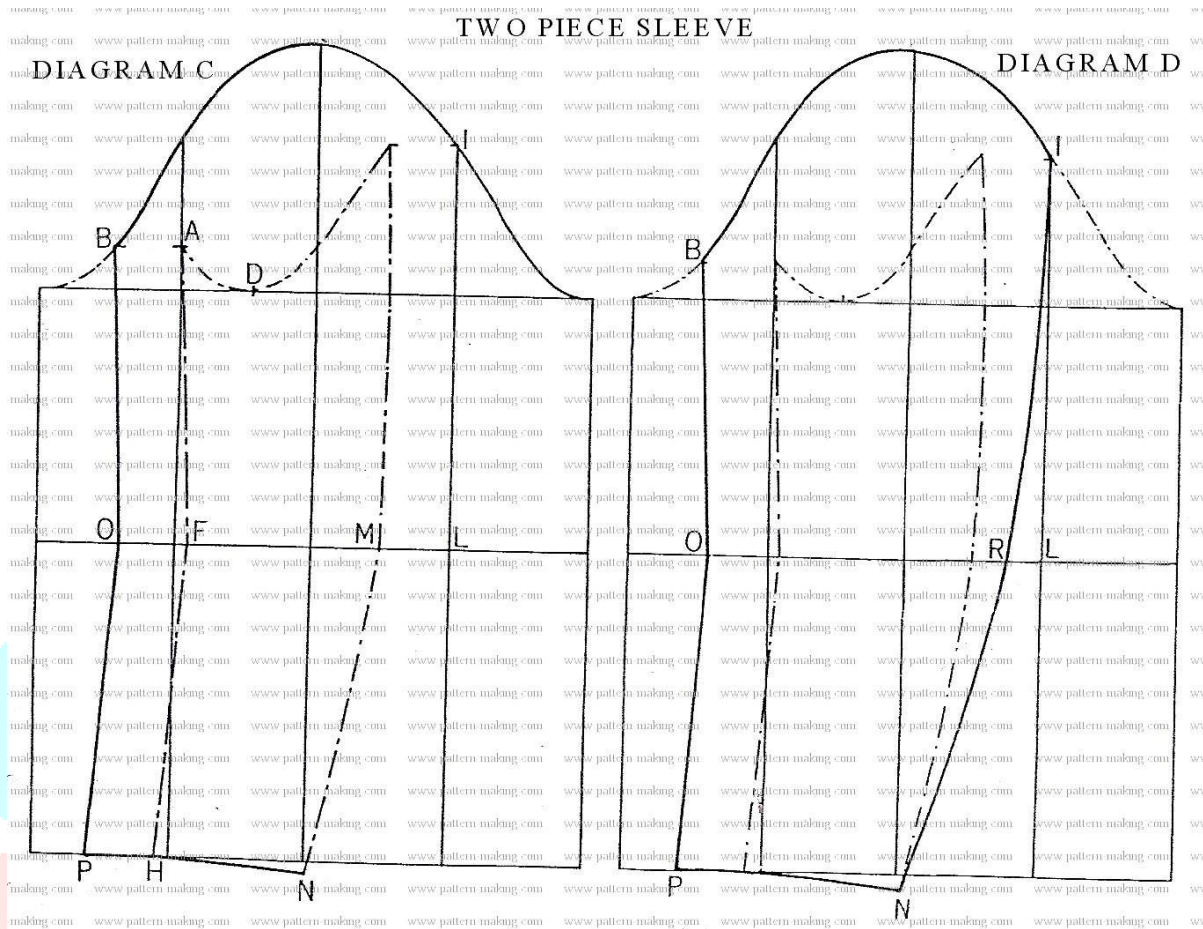

F to O = (3.5 cm)

H to P = (3.5 cm)

Connect B to O and to P with straight line to finish inseam

Connect P to N to finish cuff /wrist

Cap of upper sleeve is curve between B and O and P

I to R = center of M to L

Connect I to R with hip curve ruler

Connect R to N with hip curve ruler to finish upper sleeve

Operation Sheet 6

Drafting the Men's Trousers

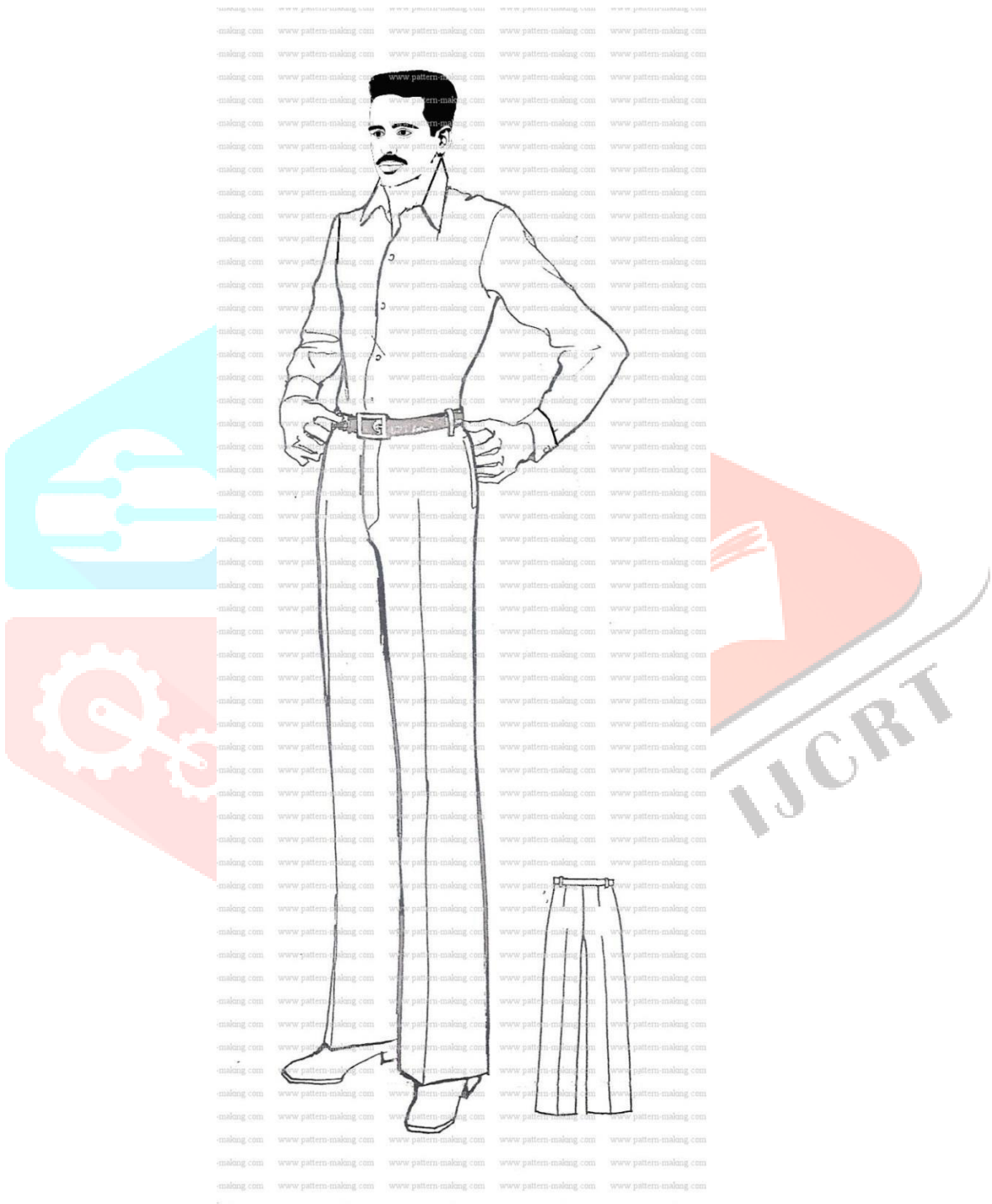

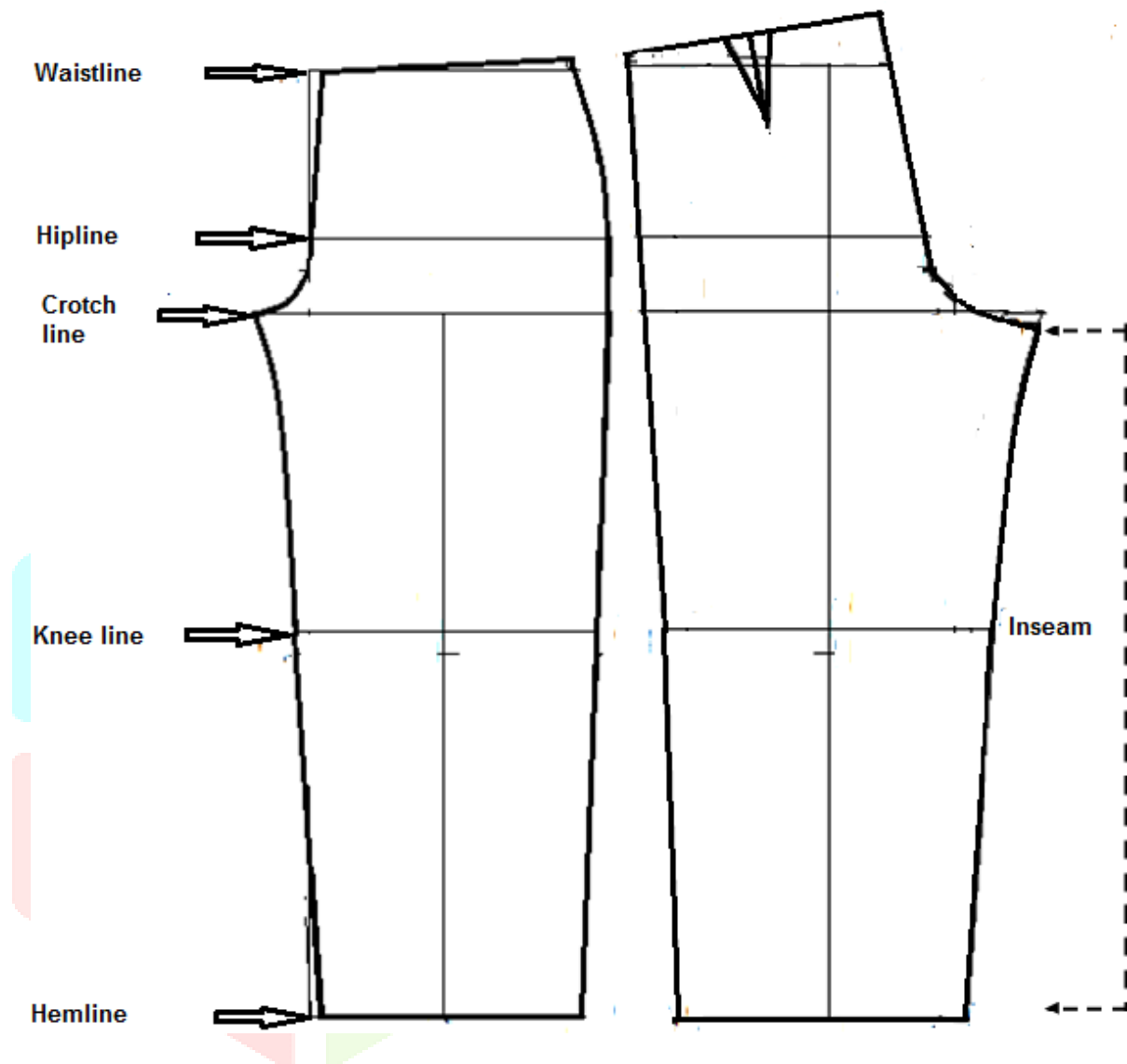

Measurements Needed :

- Waist circumference
- Hip circumference
- Crotch length
- Knee circumference
- Bottom circumference
- Pants length

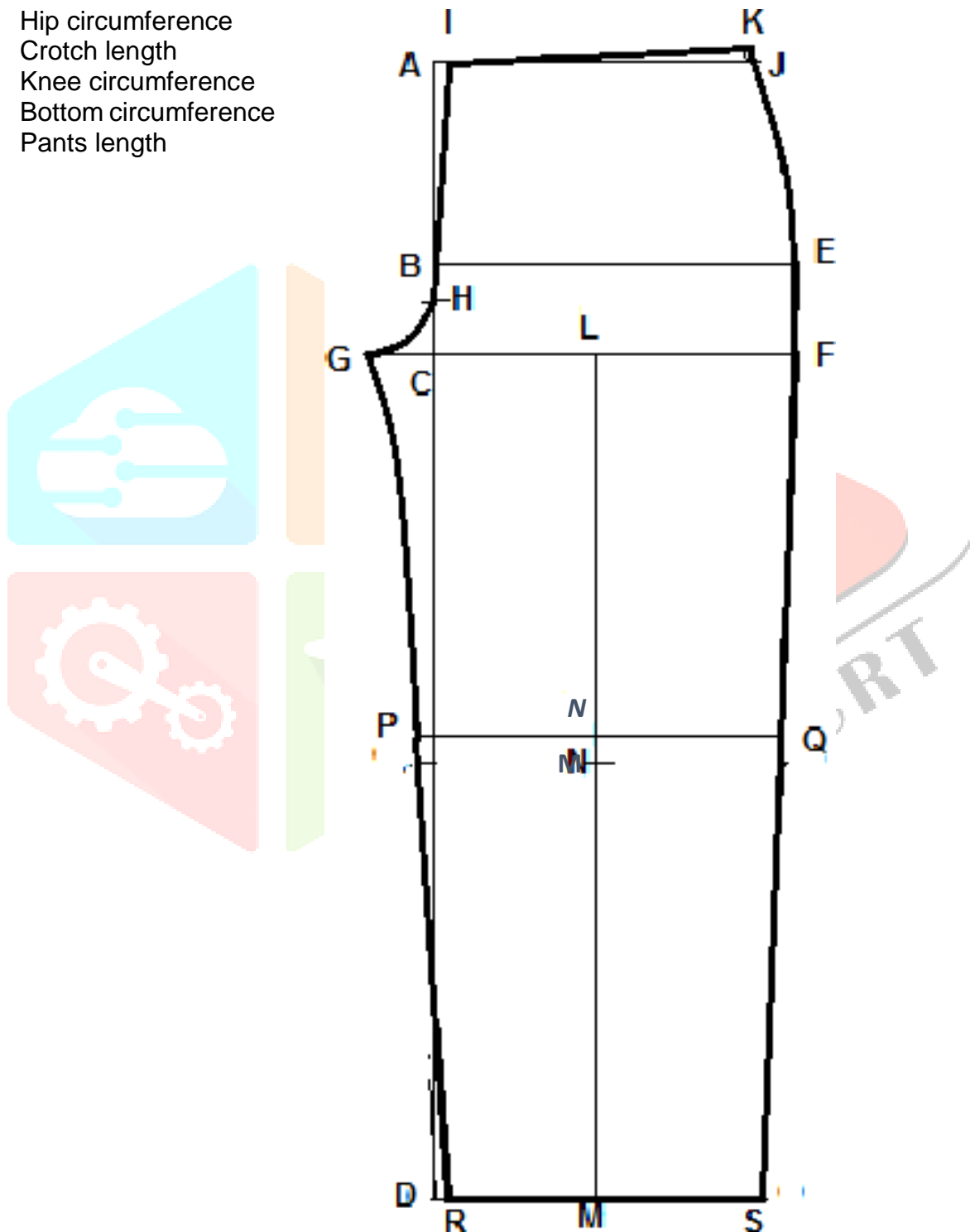

Note: Waistband width 4 cm. must be minus**A** - Starting point**A to B**= hip depth 8 inches (20.25 cm)**A to C**= crotch length**A to D**= Pants full length

Project points B, C,D perpendicularly (90 degrees)

B to E= $\frac{1}{4}$ hip circumference**C to F**= B to E**C to G**= 2 inches (5 cm)**H** = midpoint of B and C**A to I** = $\frac{3}{4}$ inch (2 cm)

Connect G to H with a French curve

Connect H to I with a straight line

I to J= $\frac{1}{4}$ waist circumference + $\frac{1}{4}$ inch (0.6 cm)**J to K**= $\frac{1}{4}$ inch (0.6 cm)

Connect I to K with a slight curve

Connect E to F with a straight line

L = midpoint of G and F

Project L perpendicularly (90 degrees)

M = midpoint of L and O**M to N**= 1 $\frac{1}{2}$ inches (4.0 cm) upward

Project M perpendicularly to the left and right

Project O perpendicularly to the left and right

O to P = $\frac{1}{4}$ knee circumference minus $\frac{1}{2}$ " (1.25 cm) (no knee measurement

Design Straight cut)

O to Q = $\frac{1}{4}$ knee circumference minus $\frac{1}{2}$ " (1.25 cm)**M to R** = $\frac{1}{4}$ bottom circumference minus $\frac{1}{2}$ inch (1.25 cm)**M to S** = $\frac{1}{4}$ bottom circumference minus $\frac{1}{2}$ inch (1.25 cm)

Connect G and P with a light curve blending R with a straight line

Connect F and Q with a slight curve blending with S with a straight line.

Note : Design is for straight cut if there is bottom measurement as requested**Apply $\frac{1}{4}$ on both side.**

BACK PANTS



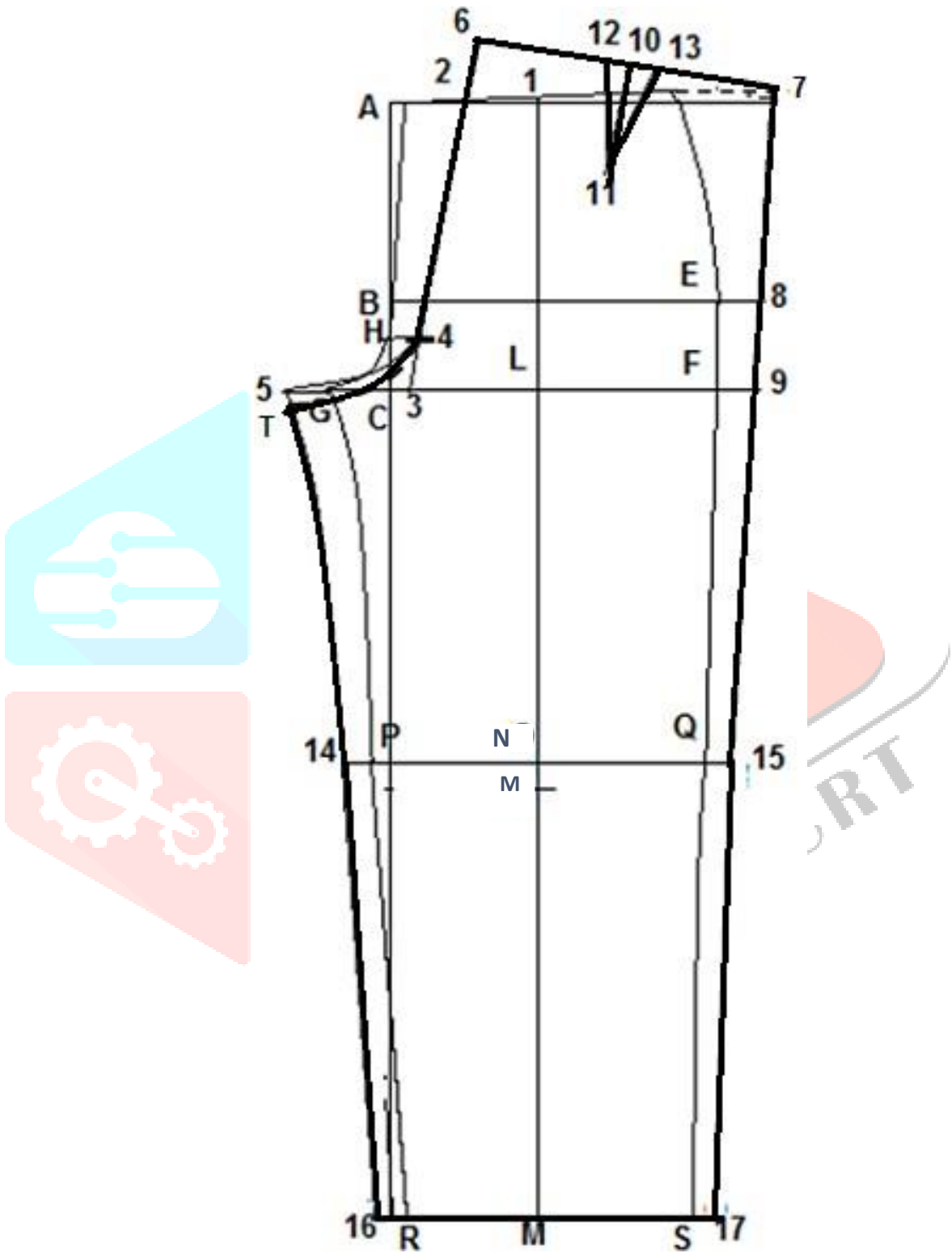

0

2 = midpoint of A and 1
C to 3 = ½ inch (1.25 cm)
4 = in line with H
G to 5 = 1 inch (2.5 cm)
2 to 6 = 1 ½ inches (4 cm)
 Project side waist point with a dotted line going the right
6 to 7 = ¼ waist measurement + ¾ inch (2 cm)
F to 9 = 1 inch or according to preferred ease
10 = midpoint of 6 and 7
 Project 10 perpendicularly (90 degrees)
10 to 11 = 3 inches (6.5 cm)
10 to 12 = ¾ inch (1 cm) **10**
to 13 = 10 to 12
 Form dart by connecting 12, 11 and 13
Q to 15 = ¾ inch (2 cm)
P to 14 = Q to 15
R to 16 = P to 14
S to 17 = Q to 15
5 to T = Crotch adjustment based on the front inseam measurement
 Shape the new crotch using a French curve
 Connect T and 4 with a slight curve then blend to 16 with straight line
 Connect 9 and 15 with a slight curve then blend to 17 with a straight line.

FRONT POCKET AND PLACKET

A to B = 6 inches (15 cm)
 Project B perpendicularly (90 degrees)
B to C = 11 inches (28 cm) **A**
to D = 1 ½ inches (4.0 cm) **A**
to E = 6 ½ (16.5 cm)
E to F = 2 inches (5.0 cm)
 Shape D and E with a slight curve line
 Shape F and C with deep curve line.

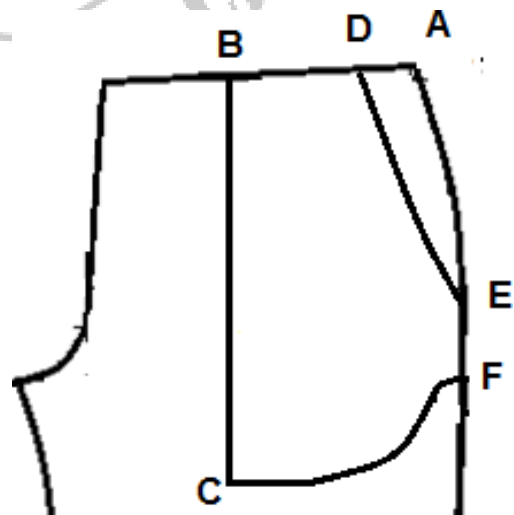

BACK WELT POCKET

A to B = 2 1/2 inches (2.25 cm) Dart

B to C = 2 1/2 inches (6.25 cm) pocket opening

B to E = B to C

Project a perpendicular line downward from C and E

C to D = 3/8 inch (1.0 cm)

E to F = C to D

Connect D and F to complete the pocket welt pattern.

Note: The pattern will be cut into centerfold with 1.0 cm seam allowance

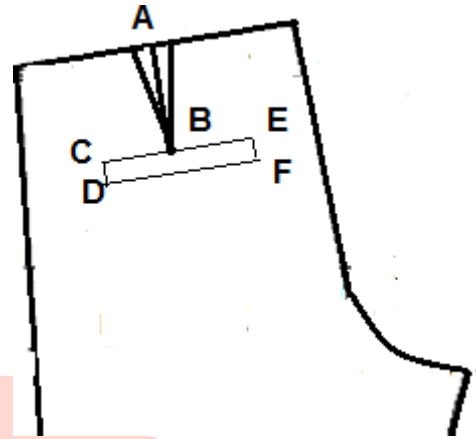

FRONT FLY FACING PATTERN

Trace the front part of the drafted trousers

A to B = 1 1/2 inches (4.0 cm)

C to D = A to B

Shape the bottom part with a deep curve

A to E = 3 1/8 inches (8.0 cm)

C to F = 3/8 inch (1.0 cm)

Shape the right fly facing following the indicated measurements in the pattern.

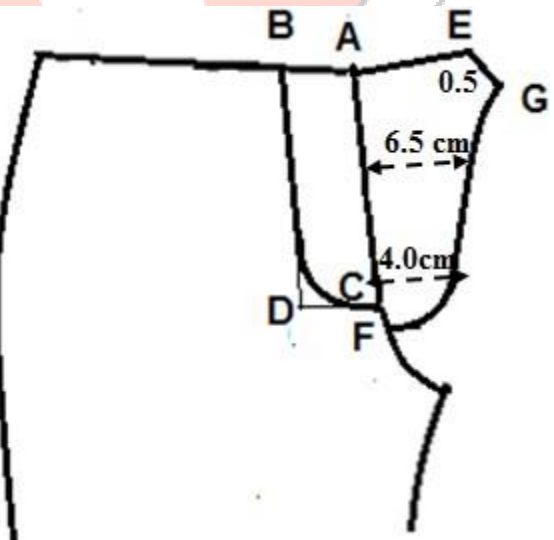

Operation Sheet 7	Drafting Final Patterns for Men's Coat
--------------------------	---

Separating Pieces

Note:

Square style lines from the pattern. The style panels, sleeve, and collar will be the base for tracing all interfacings and lining. The shaded areas indicate the traced copies of the interfacings can be traced to stitch line extended 1/8 inch beyond or to the cut line

A notch is marked on the front jacket and a notch 1/2 inch up from the bottom of the facing. Draw and trace facing tip for extra support. The jacket front and facings are completely interfaced.

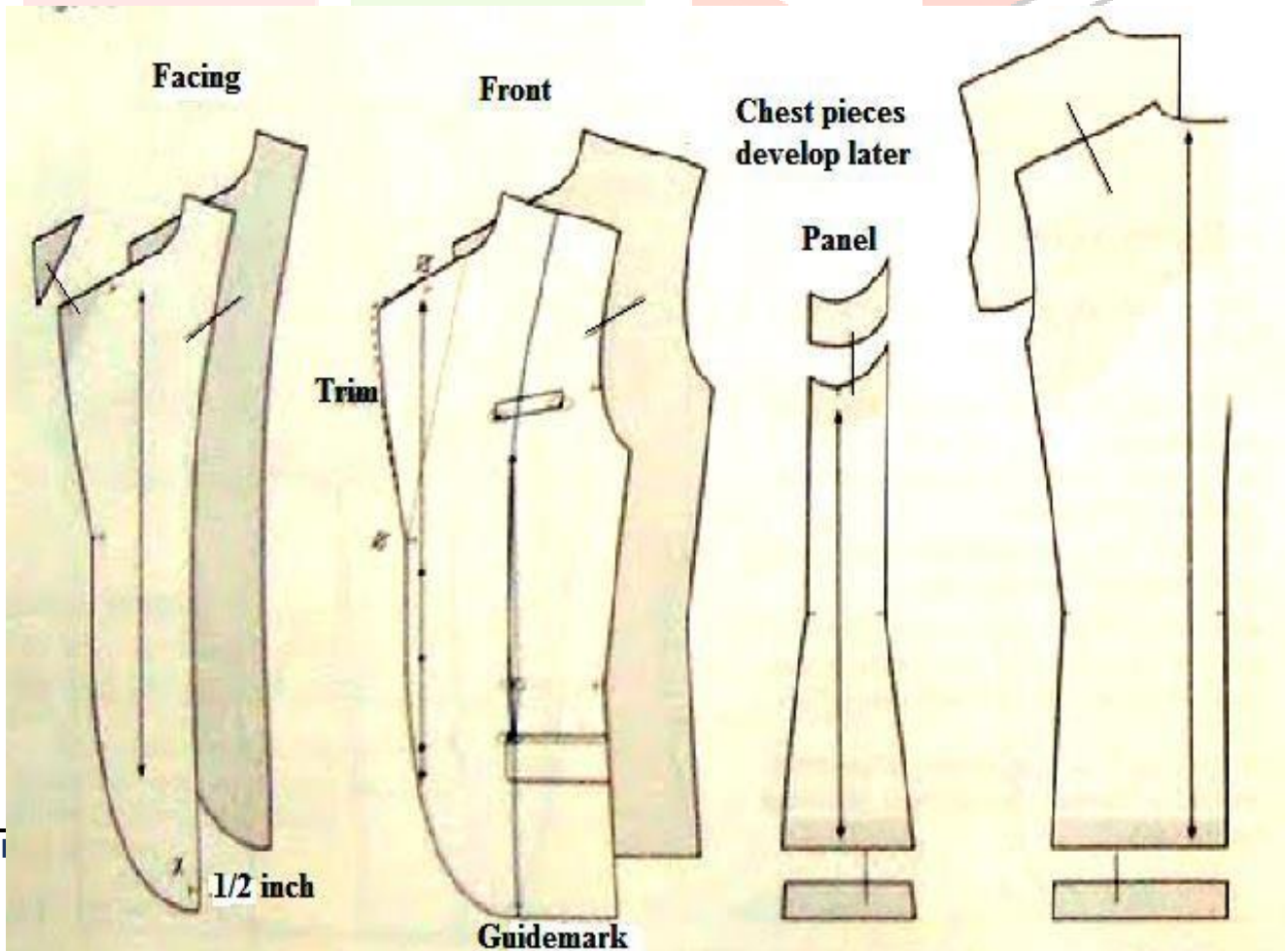

Fabric of # pieces- 6 pieces (Front panel, side panel, Back Panel Front facing
Upper sleeve and lower sleeve)

Two-piece Sleeve

Note: Cut interfacing around the armhole 5cm
Wrist hemline 5cm and Sleeve Vent 13x4cm

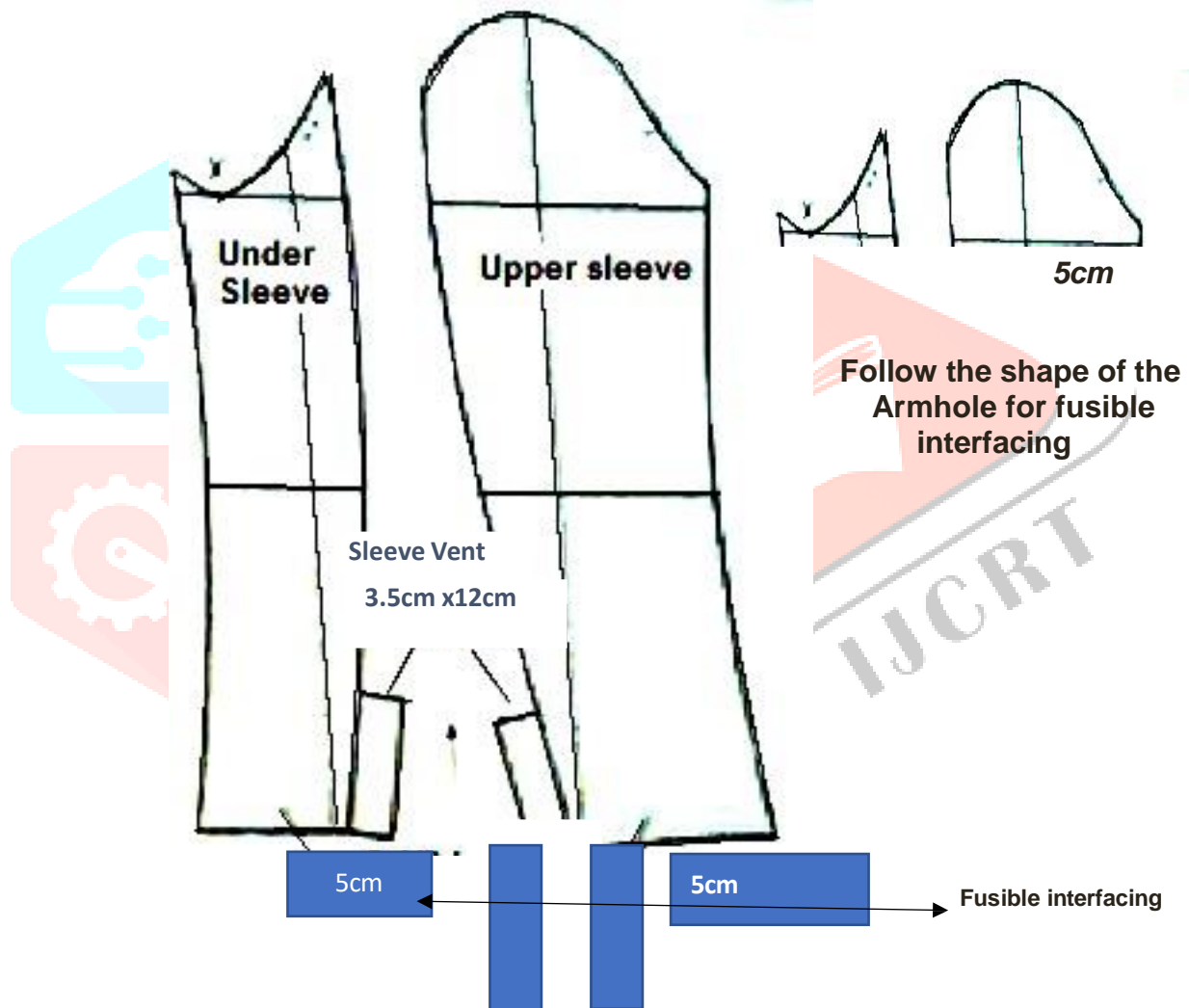

Sewing allowances:

Shoulder- 2.0cm

Side seam- 1.3cm

Armhole- 1.5 cm

Hemline- 4cm

Vent side seam -1cm

Interfacing for Collar

Figure 5

- **Upper collar:** Trace collar on fold. Mark 1 inch (2.5 cm) for roll line (see broken lines).
- **Roll line:** Trace a copy of the roll line pattern. Cut in fusible interfacing or top-stitch Belgium linen to the collar.
- **Under collar :** Trace the upper collar to center back. Figure A

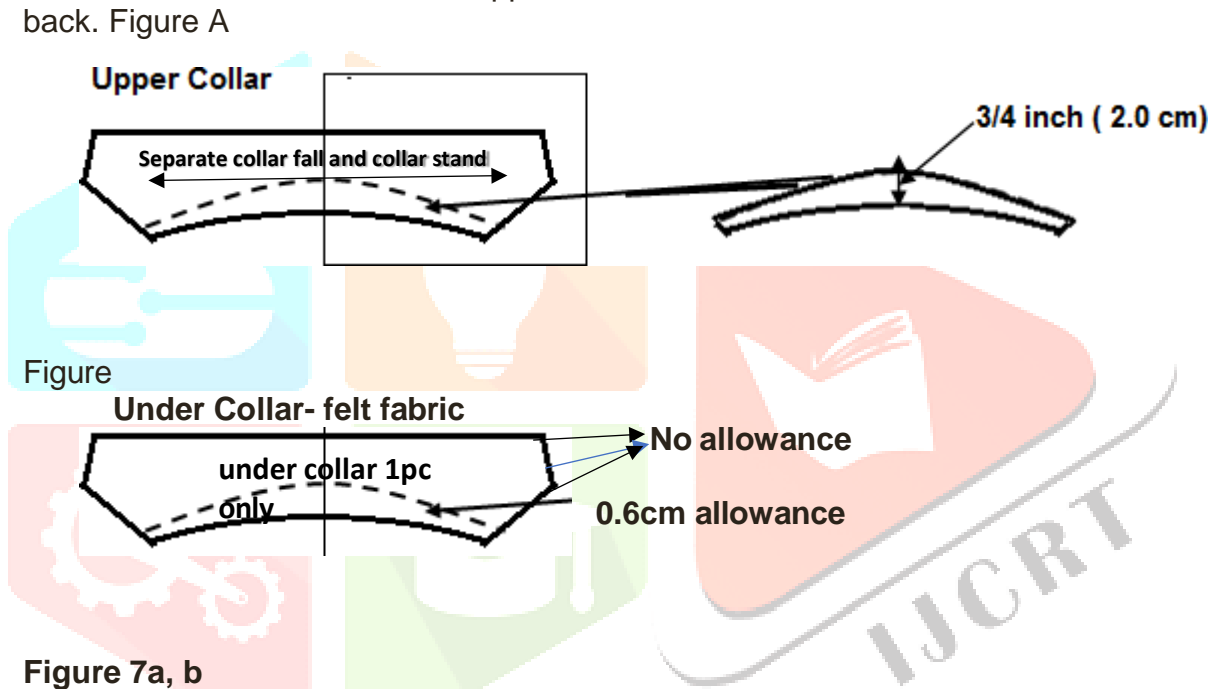
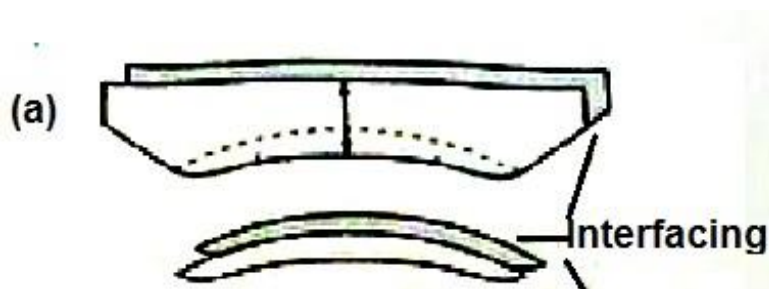

Figure 7a, b

Collar pattern;-Support is added by cutting a fusible interfacing, which is places on the upper collar, under collar, Felt Fabric (shaded area(a). The crescent shape may be cut in felt fabric



Lining Patterns

Figures 8a,b

- Trace the jacket patterns.
- Draw front lining following the dart leg (absorbs dart in the princess seams.
- Extend hemlines $\frac{1}{2}$ " (1.25cm) ; notch 1" (2.5 cm) for fold of hem.
- Trim shoulder tips to mid-shoulders to eliminate allowance for shoulder pads (slash lines)
- Add $\frac{1}{8}$ inch (0.3 cm) to seams, extend $\frac{1}{2}$ inch (1.25 cm) under sleeve, trim sleeve cap .(on the total measurements of the body
- Add 1 inch (2.5 cm) at the center back for stress-release pleat.

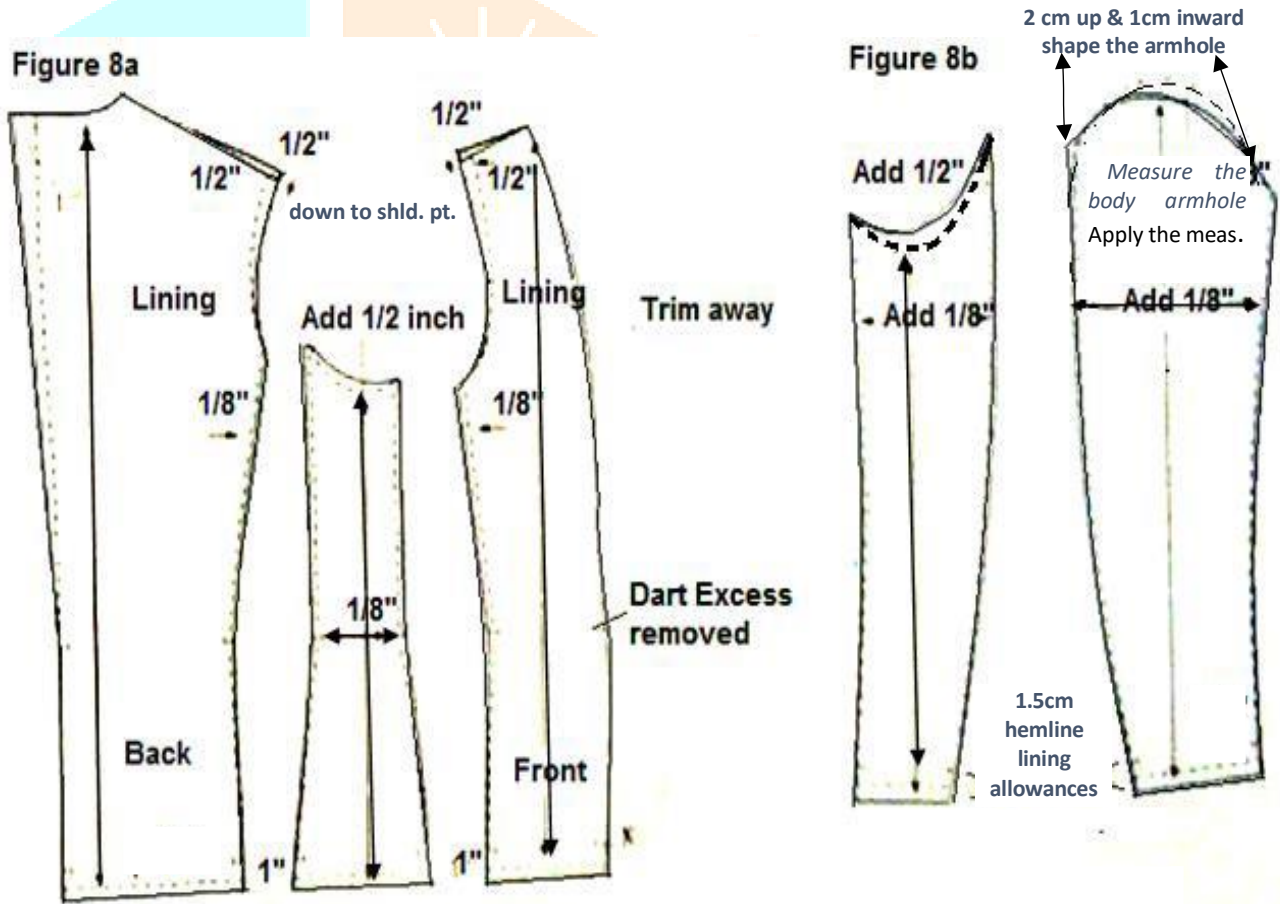

Lining is bigger for movement

Jacket and Lining seam allowances

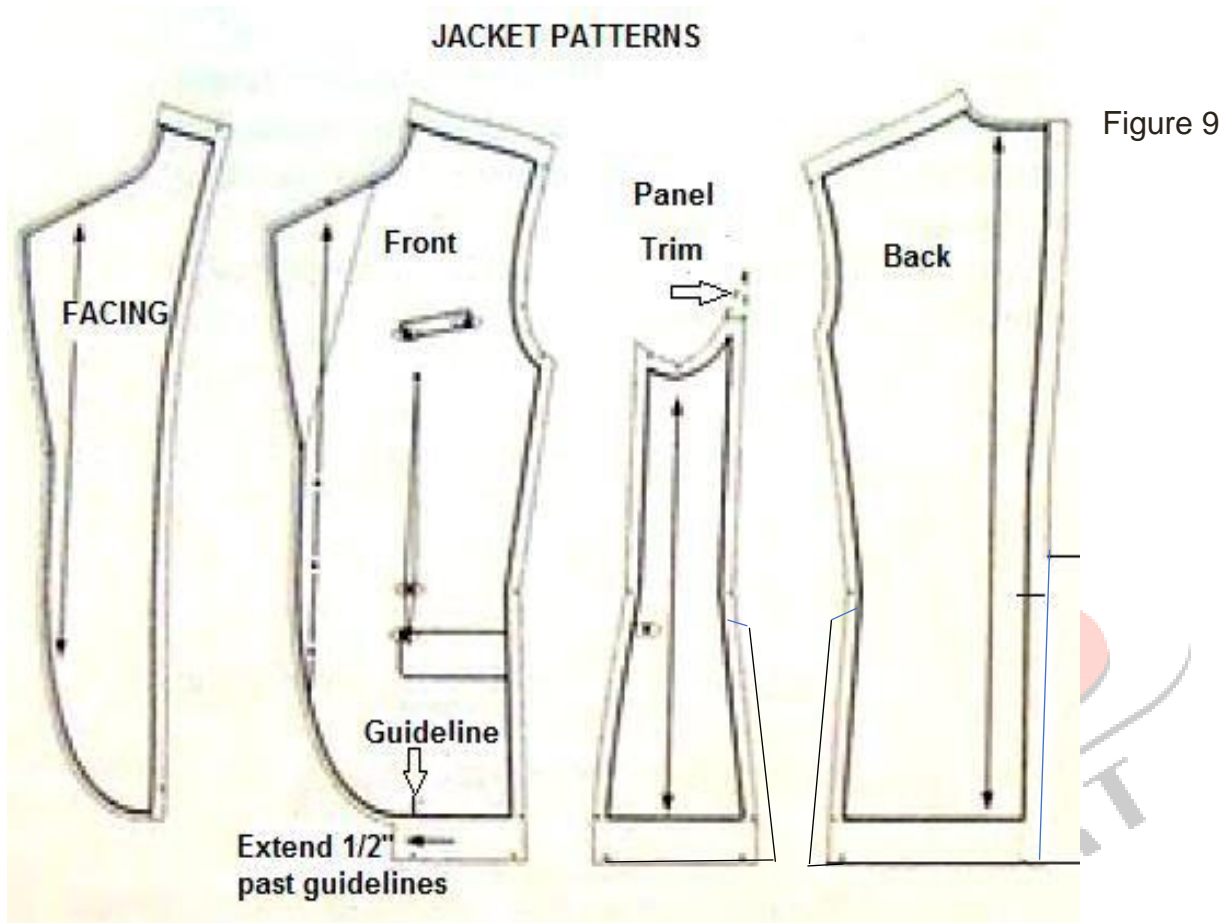

- Shoulder lines (jacket and facing) = $\frac{3}{4}$ inches (2.0cm)
Allowance for fitting adjustment
- Other seams $\frac{1}{2}$ inch (1.25cm) Option: Tailor seams $\frac{3}{8}$ inch
- Hemlines = $1 \frac{1}{2}$ inches (4cm) (hem ends $\frac{1}{2}$ inch past guideline) on the jacket patterns

Color codes

Color-coded patterns group fabrics of the garment. Industry choices may differ from the list given.

- Jacket - black
- Lining - blue
- Interfacing - red - if more than 1 type. Code each with different color
- Interlining - green

Lining Patterns

Figure 10

- Add ½ inch (1.25 cm) to all seams, except at hemlines

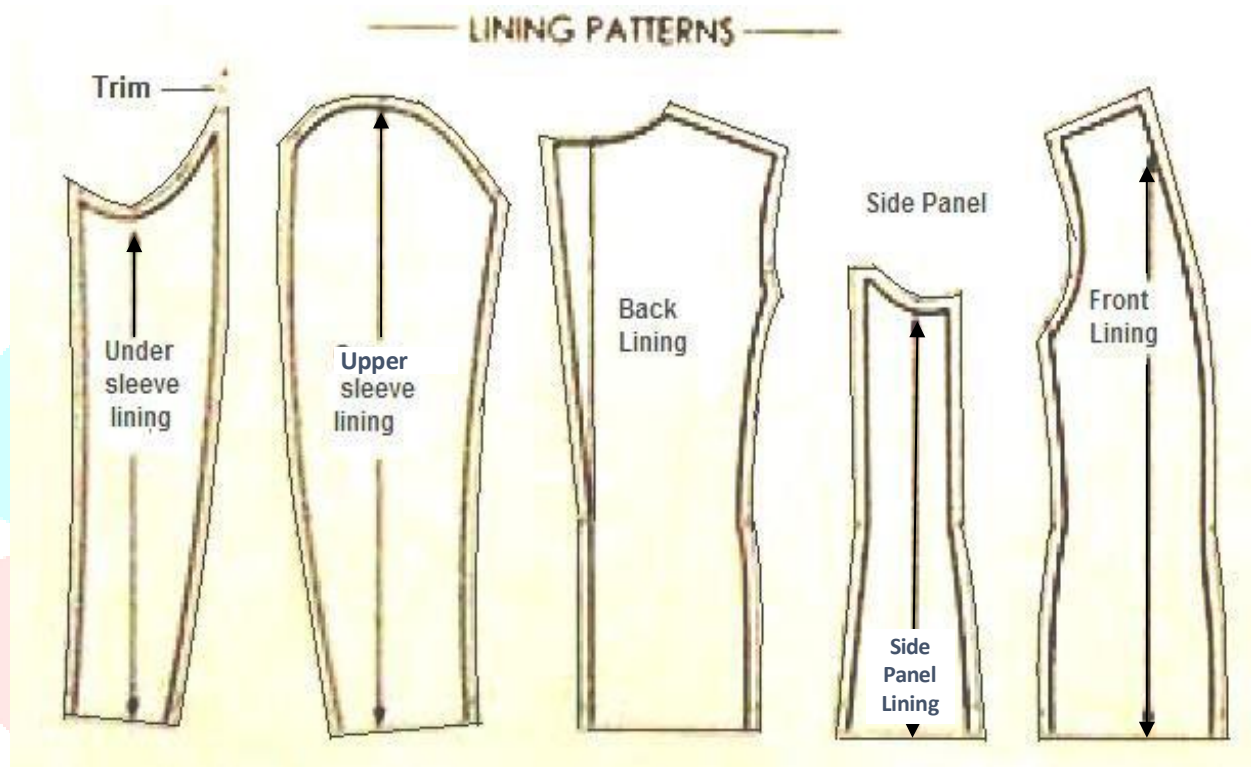

- Apply the grainlines, mark the position of the pocket lining (see specification)

Collar and sleeve seam allowances

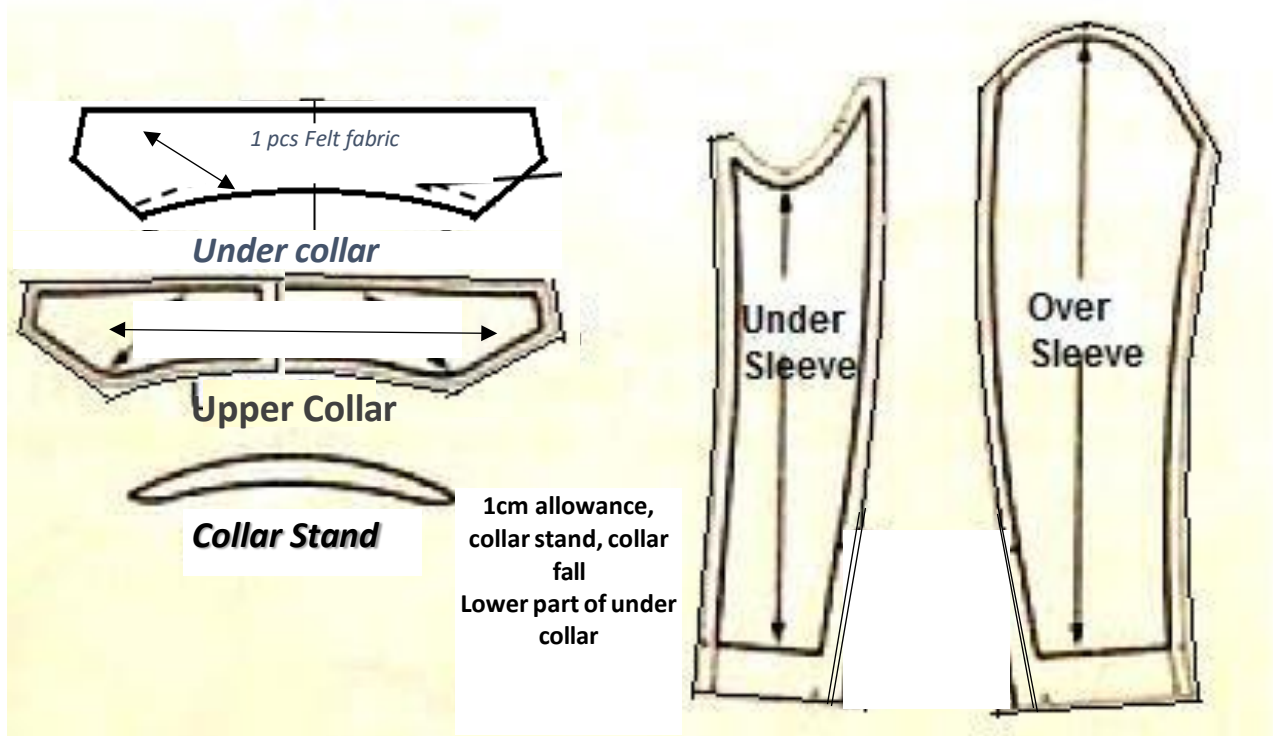
**Pattern Information**

Label: Each pattern requires a

- style number
- size
- number of pieces cut
- identification
- Draw grain lines, dart, position of pocket

Note: Check both sides, notch and no. of pieces

Operation Sheet 8	Drafting Final Patterns for Men's Trousers
--------------------------	---

Apply the following measurements for the seam allowances :

Trousers Parts	Inches	Centimeters
Waist	3/8 , back side waistline 1 1/2	1.0, 4cm
Crotch	3/8 (back 3/4)	1.0 (back 2.0)
Side	1/2 F& B	1.25
Hemline	1 1/2	4.0

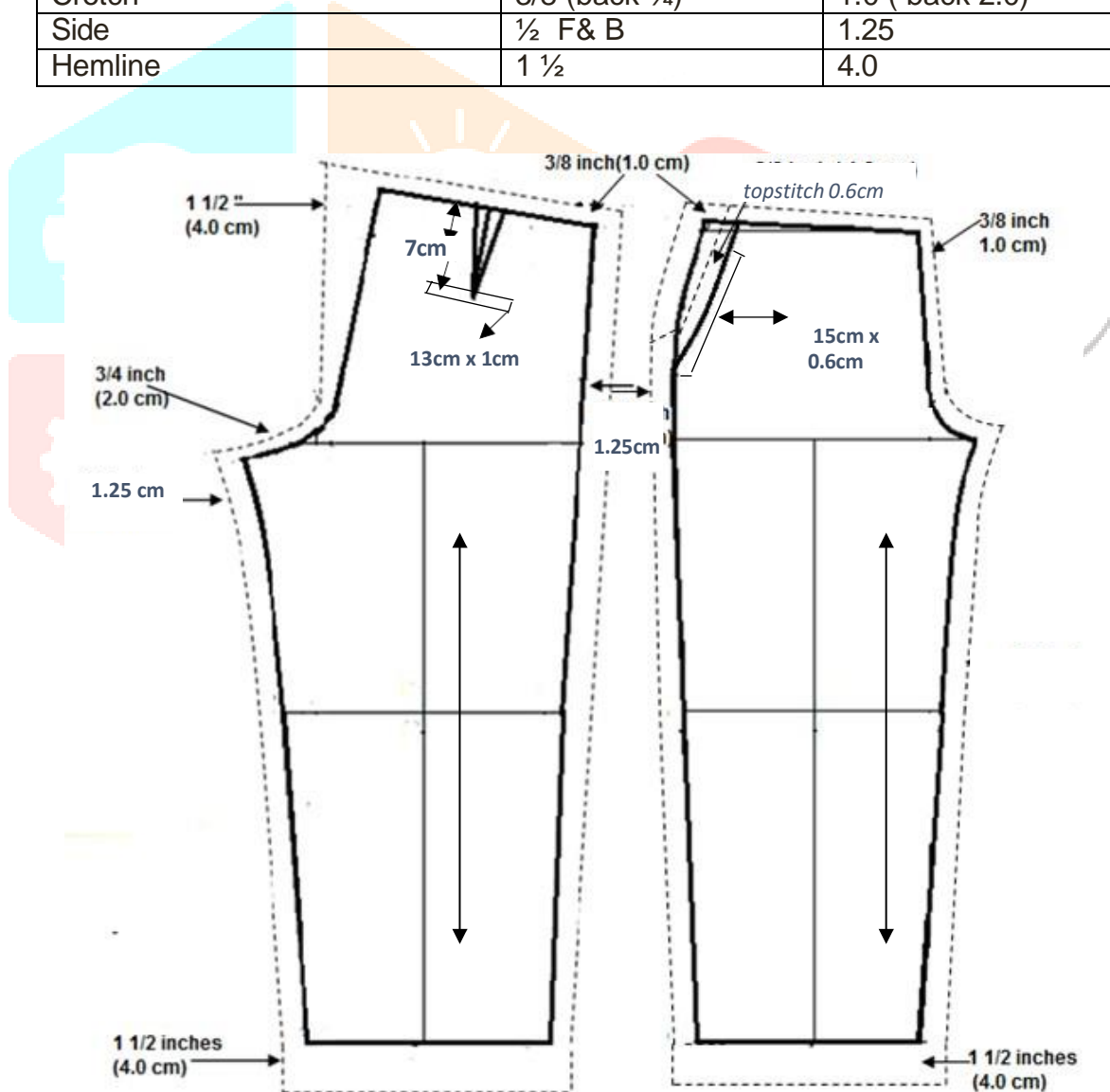

Legend:

----- Cutting line

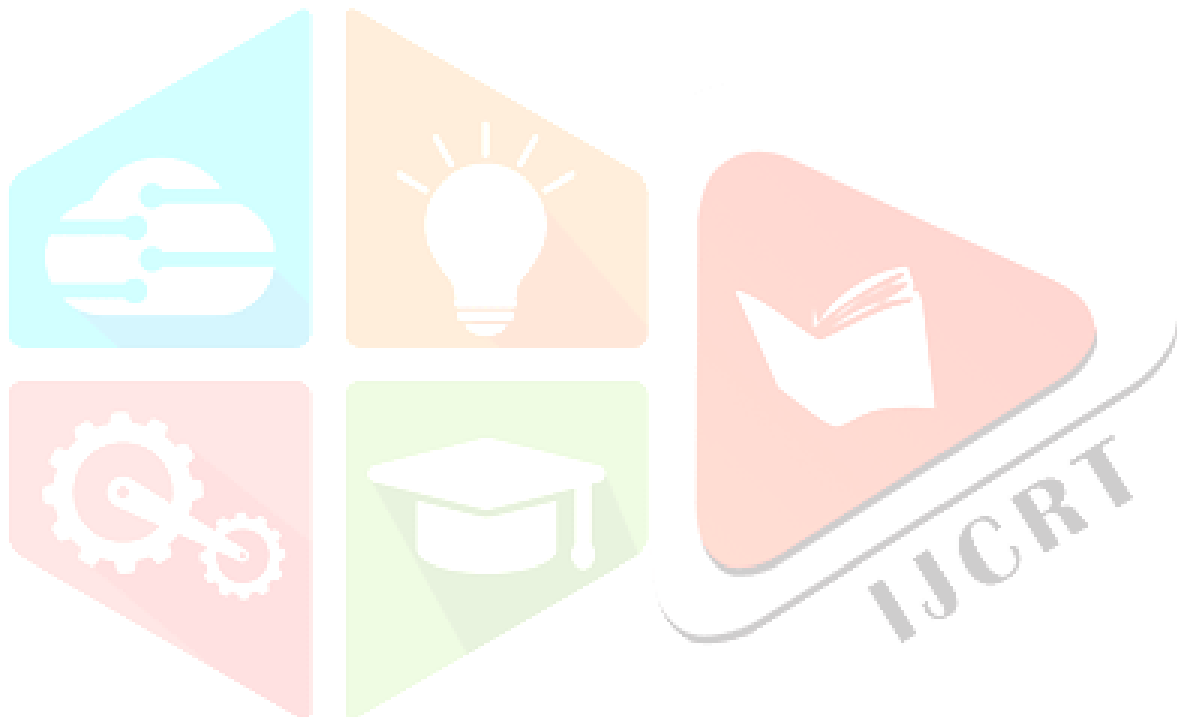

——— Stitching line

Note: Trace frontpart for the lining pattern down to the knee level with 0.3cm both sides..

Pockets

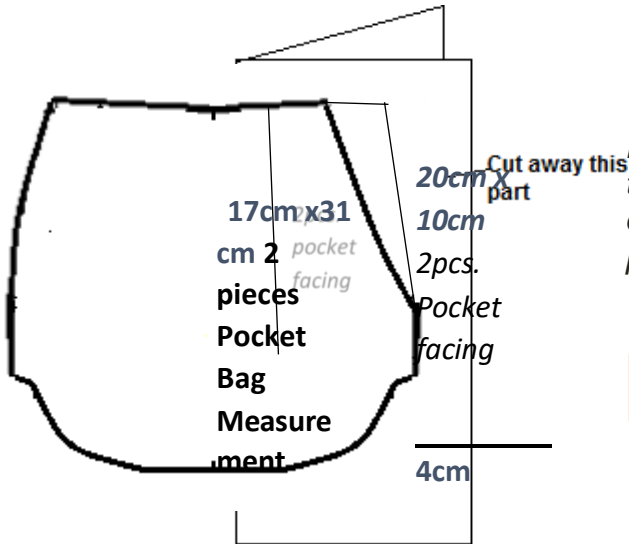

- Cut pockets in center fold
- Provide 1 cm allowance for the pocket lips
- Trace the dotted line for the pocket facing
- Cut the pocket and facing in two pieces

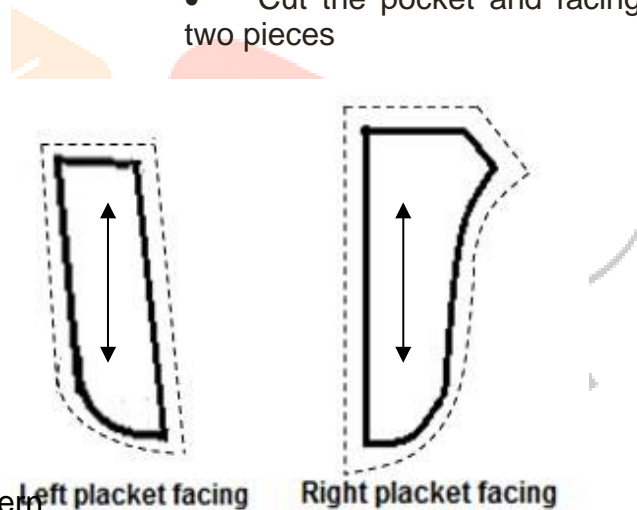

Placket Facings:

- Trace left and right placket developed from the front pattern
- Provide 1 cm allowance around.
- Cut one piece each for the wool fabric and 1 piece each for the lining (Left fly ,wool fabric , right Fly lining fabric)

Waistband

- Cut waistband in 2 pieces 1cm allowances both sides

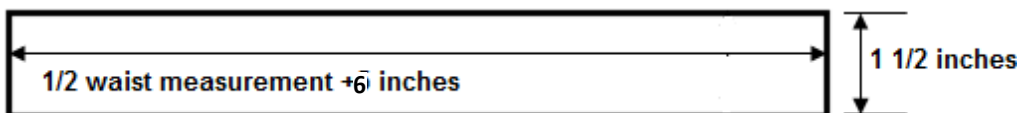

Belt loops

6pcs. –8cm x 1cm

Operation Sheet 9**LAYING-OUT AND CUTTING THE COAT****PURPOSE:**

To utilize the fabric efficiently

CONDITIONS FOR OPERATIONS:

Preshrink all fabric associated with the pant before cutting and stitching the coat. The amount of yardage needed depends on the width of the fabric, size of the pattern parts, and amount of garments to be cut.

MATERIALS, TOOLS AND EQUIPMENT NEEDED:

Qty	Unit	Description
1	set	Coat Pattern
1	pack	Pins
1	pair	Fabric Shears

PROCEDURES:

- To cut one garment, the patterns can be traced directly on the fabric, as illustrated.
- The grain line of the patterns are placed parallel to the selvage.
- Large pattern parts are laid first, and the remaining patterns are fit into the available spaces.
- The rule is to closely interlock the patterns to avoid wasting fabric. In the workroom or classroom, sample layouts also help to determine the amount of fabric needed for the project.
- A pattern's layout guide for lining and interfacing is given here.

Jacket Patterns

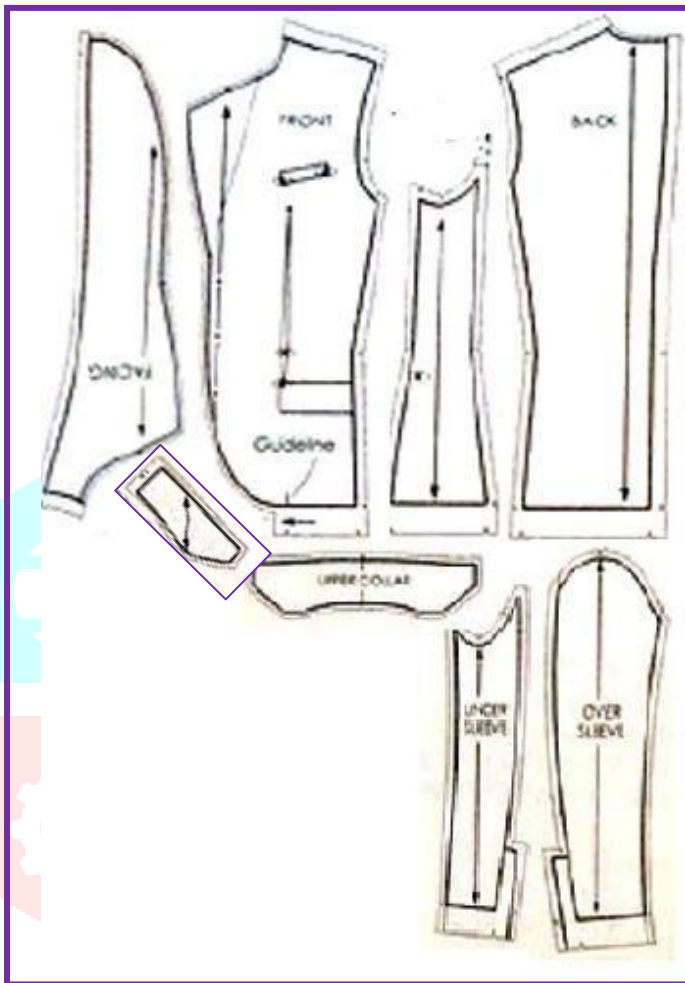

Note:

Other small components like pocket flaps, welt and facing will be laid-out last to fill spaces

LINING Patterns

Note:

Small lining components for pocket bags and flap will be laid out on free spaces.

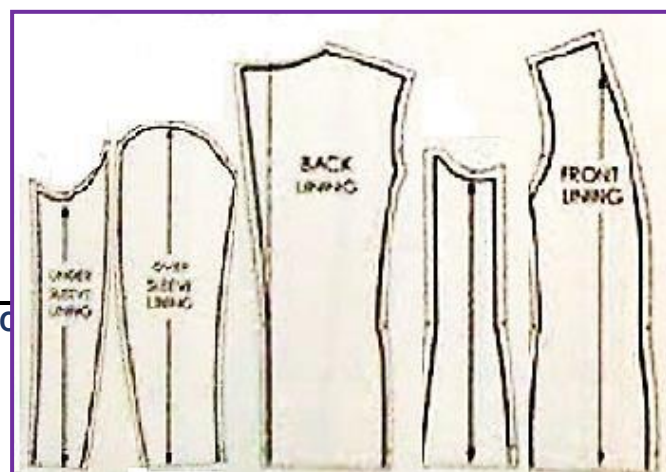

Operation Sheet 10

LAYING-OUT AND CUTTING THE TROUSER

PURPOSE:

To utilize the fabric efficiently

CONDITIONS FOR OPERATIONS:

Preshrink all fabric associated with the pant before cutting and stitching the trouser. The amount of yardage needed depends on the width of the fabric, size of the pattern parts, and amount of garments to be cut.

MATERIALS, TOOLS AND EQUIPMENT NEEDED:

Qty	Unit	Description
1	set	Trouser pattern
1	pack	Pins
1	pair	Scissors

PROCEDURES:

- To cut one garment, the patterns can be traced directly on the fabric, as illustrated.
- The grainline of the patterns are placed parallel to the selvage.
- Large pattern parts are laid first, and the remaining patterns are fit into the available spaces.
- The rule is to closely interlock the patterns to avoid wasting fabric. In the workroom or classroom, sample layouts also help to determine the amount of fabric needed for the project.
- A pattern's layout guide for lining and interfacing is given here.

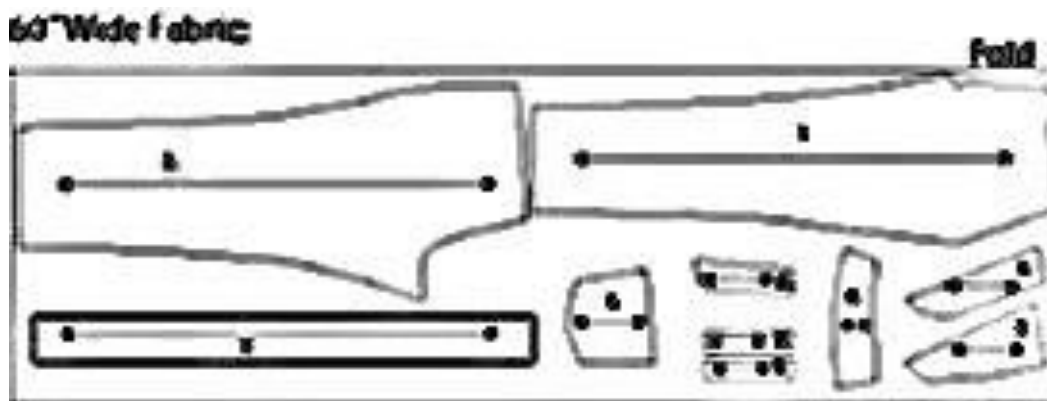
Fabric Width of 60" inches (Center-folded)

Fabric Width of 58 or More Inches (Open)



The fabric can accommodate all pant parts across the width of the goods. *Yardage needed* is one pant length, plus 1/8 yard. The pocket backing, facing, waist band, and belt loops are cut in "self"-fabric and are a part of the marker. The pocket pouch and full lining is cut in the lining fabric of choice. Cut interfacing for the pocket facing, waist band, and fly

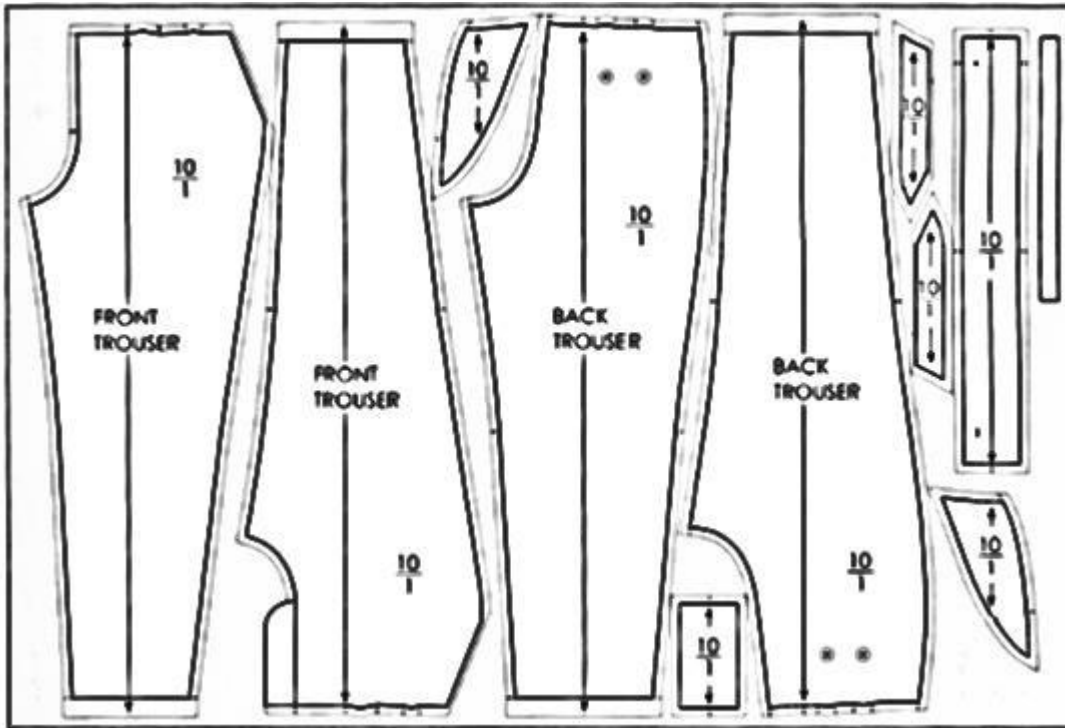

Lining Patterns

The pocket pouch and full lining are cut in lining (cotton, rayon blend or self).

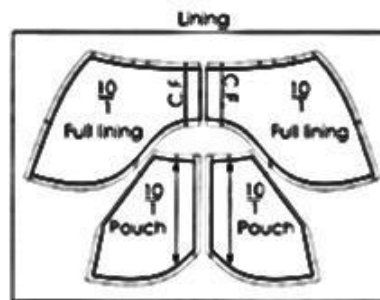

Interface the Following Patterns

Cut interfacing to seamline of the facing, backing, belt, and fly.

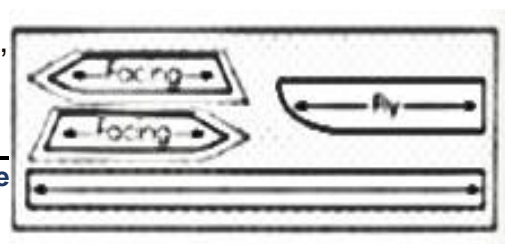

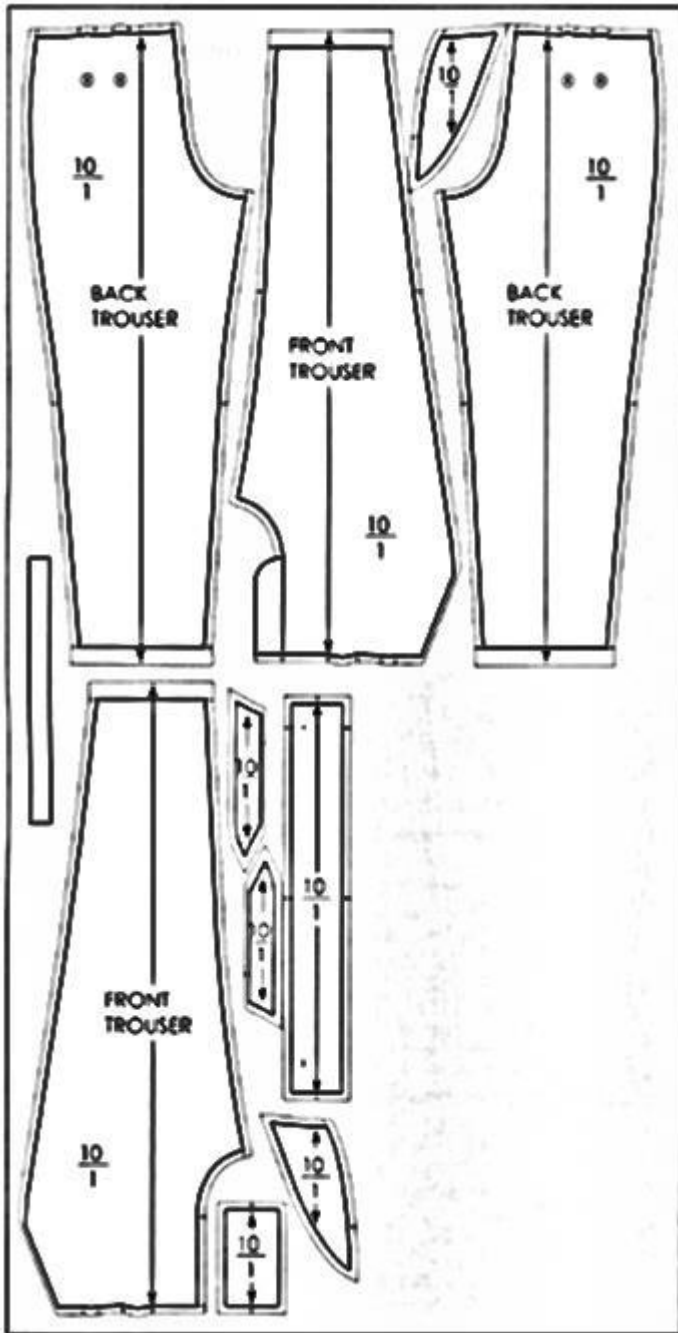

Fabric Width of 45 to 48 Inches

The width of the fabric accommodates three pant patterns across the goods. *Yardage needed* is two times pant length, plus 1/8 yard. The pocket backing, facing, waist band, and belt loops are cut in "self" fabric and are a part of the marker. The left-over fabric can be saved for other uses.



Operation Sheet 11

LINED MEN'S COAT CONSTRUCTION

PURPOSE:

Assemble lined men's coat according to specifications and quality standards

CONDITIONS FOR OPERATIONS:

- When the garment shell has been fitted, remove the bastings and separate the main sections.
- Remove the interfacing as well and thread trace the pinned roll line markings
- If alterations are needed, make all necessary changes on the garment and interfacing units.

MATERIALS, TOOLS AND EQUIPMENT NEEDED:

Qty	Unit	Description
1	set	Coat components with interfacing, underlining, lining
1	pack	Pins
1	set	Basting needle and thread
1	unit	Steam press
1	unit	Lockstitch sewing machine
1	pair	Scissors

PROCEDURES:**APPLYING INTERFACING**

Fusible Interfacing has an adhesive (resin) backing on one-side and is placed on the wrong side of the fabric. Resin melts into the fiber when the steam or heat is applied. The interface pattern can be cut to seam of the garment, or have 1/8 " to 1/2" allowance to the interfacing. Interfacing can be woven or non-woven, with or without fusible backing.

APPLYING INTERFACING*Figure 1*

Fuse interfacings where indicated. Mark for button placements, and for the flap and welt. Chalk-mark rolls line to breakpoint. Start bridle tape 3 inches above breakpoint on roll line. Continue tape on the lapel, ending 1 1/2" past the curve at hemline.

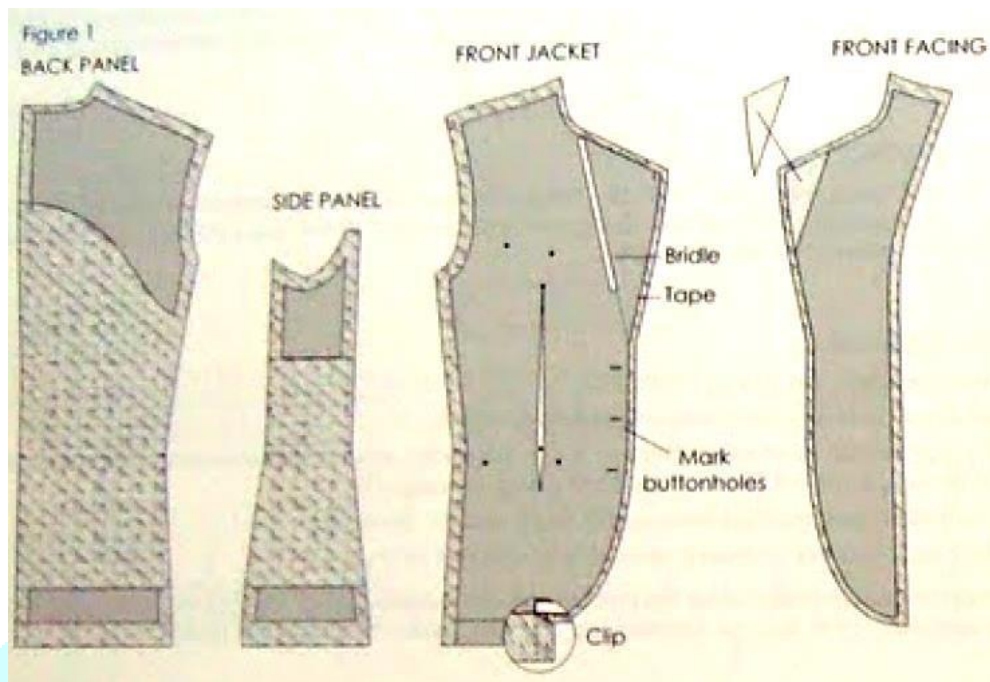

Patterns for Chest Support

Figure 2a, 2b

Trace front jacket pattern to draw three layers of interfacing patterns (a).

A firm chest piece is illustrated as three layers, first layer (1), second layer cut from **Belgium linen, horse-hair or Hymo** and trimmed $\frac{1}{4}$ inch all-around (2). And third layer fuses all layers to the garment (3).

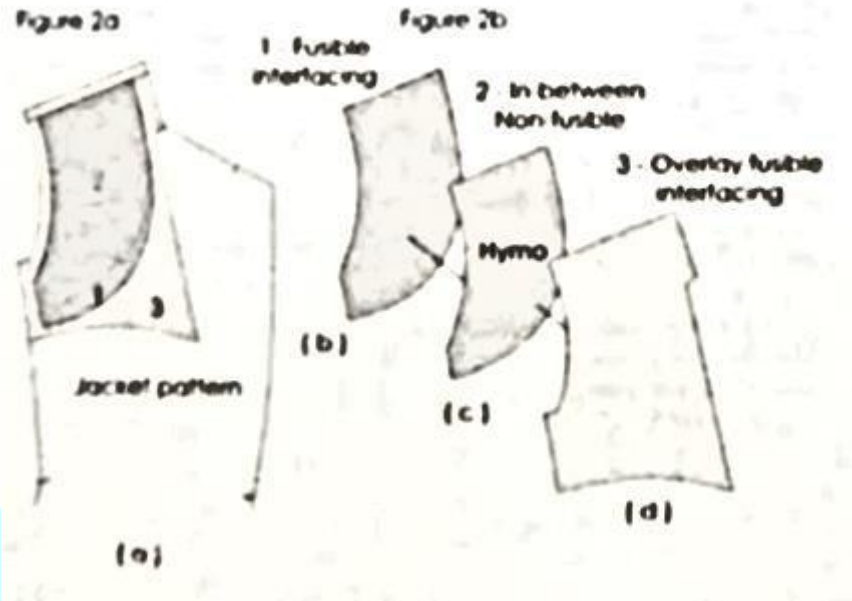

Collar and Sleeve Interfacing

Figure 31a, b

The upper fused. The crescent-shaped interfacing is fused to the undercollar and stitched in rows to stabilize roll line as collar folds over. Felt fabric the under collar

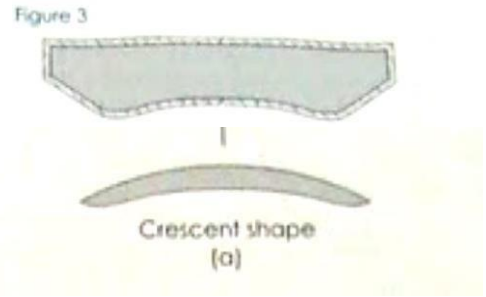

Two—Piece Sleeve with Vent 5cm -width of interfacing

Upper sleeve: Fuse interfacing ending 1/2" below the fold of the hem and on vent extension.

Undersleeve: Fuse interfacing ending 1/2" below the fold of the hem.

Fused the sleeve cap of upper and under sleeve

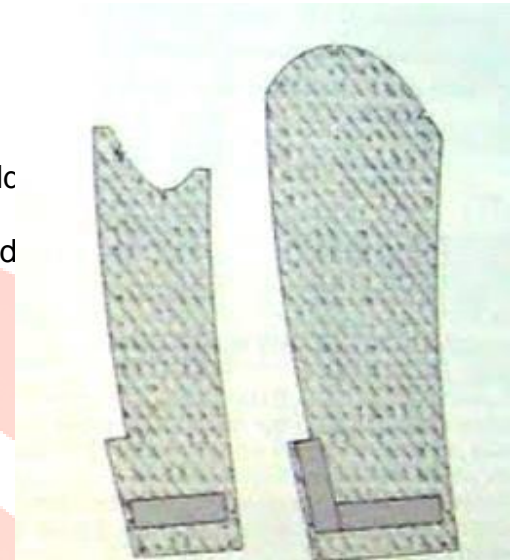

ASSEMBLING THE JACKET

The sequence can be changed if preferred. Prepare the **collar**, the **flap** and **welt pockets**, and **sleeves**. Set aside until ready for use.

Preparing the Collar

Figure 4

- Stitch back seams together and press open
- Fuse crescent shape at stitchline of collar fall.
- Stitch two to three rows to add firmness.

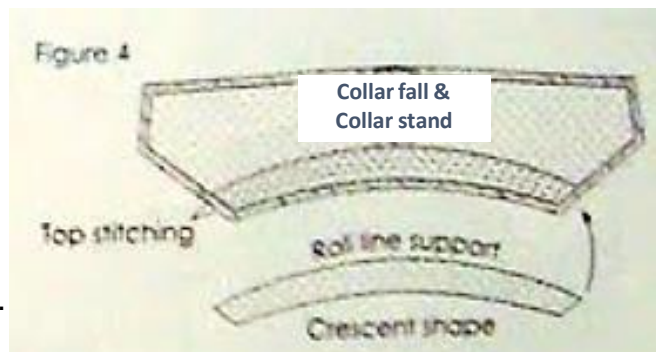

Preapring Chest

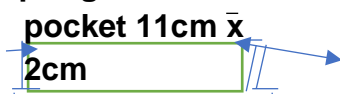

1cm

folded

14 x 12cm -pocket bag

Preparing the Flap

welt - double
8cm x 20cm- 2 pcs.

pocket Bag
19cm x 60 cm-2pcs.

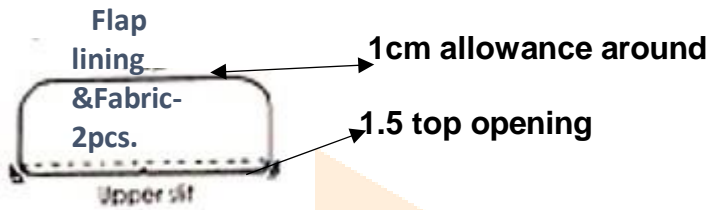

inside fabric facing-
8cm x 19 cm- 2pcs.

Stitch Waist Darts

Figure 7a,b, c

Two methods are illustrated:

1. Stitch waist dart. Place a bias strip of fabric underneath and stitch to darts. Press darts to one side and fold bias on other side (a).
2. Stitch dart. Cut through fold (b)
3. Press. Fuse squares on ends (c).

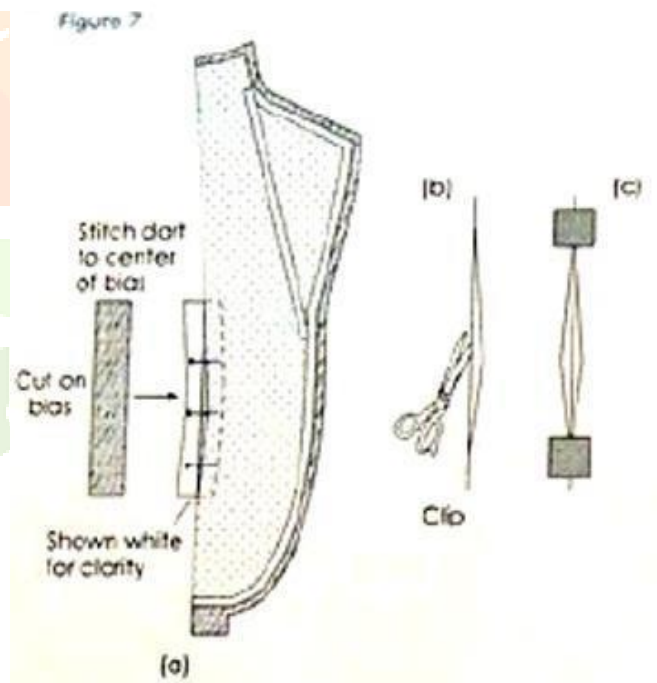

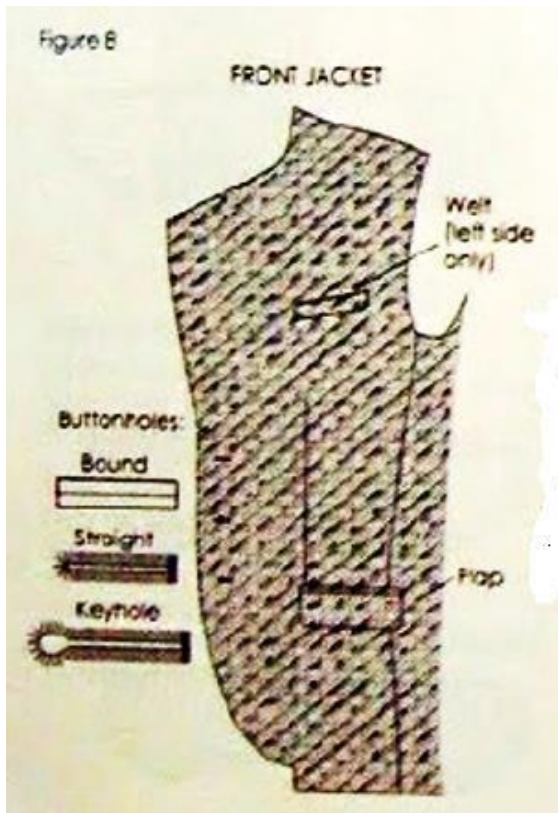

Preparation for Flap and Welt Pockets

Figure 8

Stitch side panel to front jacket, press seams open.

Choose the buttonhole from the three styles. Bound buttonholes, are made before the facing is stitched to the garment.



Applying the Chest Piece

Figure 9a, b

Place first layer at the stitch line of armhole, shoulder, and side.

Heat to seal. Next, place hymo on top of the first layer. Last layer placed to the seam allowance of shoulder armhole, and side. Heat will fuse top layers, securing support for the front jacket. Sew panels, center back, and shoulders. Press seam open.

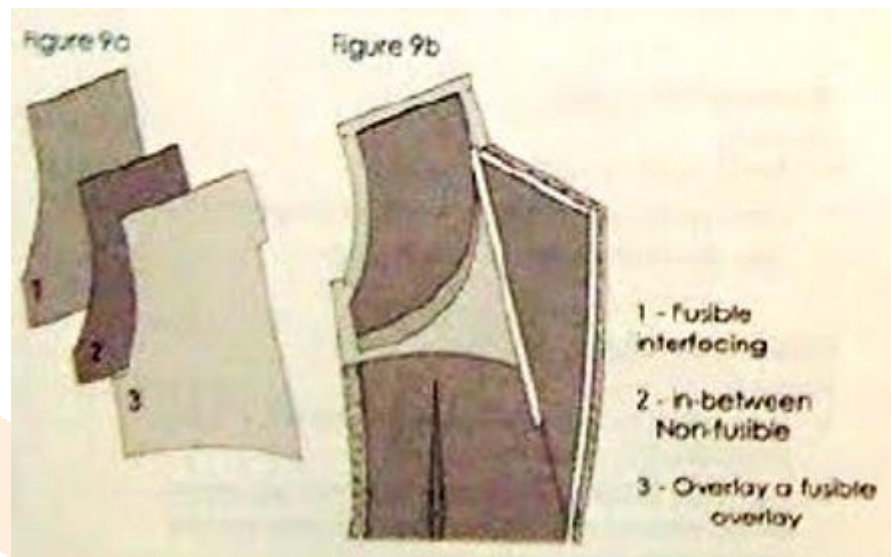

Preparing the Sleeves

For sleeves without vents, omit the instructions that do not apply

Figure 10a to 10d

- Sew seam from sleeve cap to vent, pivot and stitch $\frac{1}{4}$ inch to hem (Figure 10a). Press seam open.
- Run a gather stitch around cap seam from notch to notch and a row $\frac{1}{4}$ inch above.
- Stitch halfway down the remaining seam (Figure 10b).

**Option to avoid thickness (Figure 10 c) Stitch $\frac{1}{2}$ inch above fold of the vent hem and down elbow seam to hem. Trim*

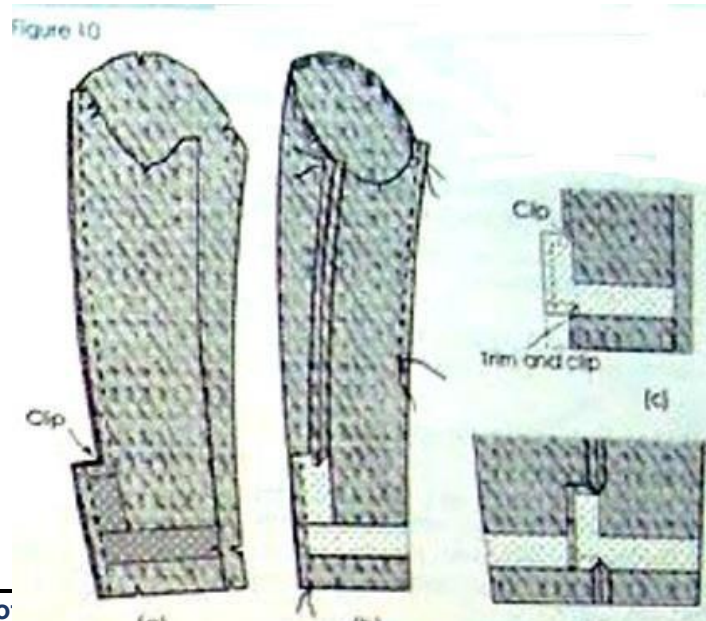

excess, allowing $\frac{1}{2}$ inch seams.

- Press seam open. (Figure 10d)



Sleeve Cap

Figure 11

Cut a length of twill that equals the distance from front armhole notch to back notch, plus 1 inch. Pin mid-point of tape to stitchline at top cap and pin at each notch, allowing 1/2 inch to hang below. Pull gather threads until fullness equals the length of the tape and is distributed evenly. Knot threads. Sew tape to sleeve cap at stitchline. Crimp cap fullness desired.

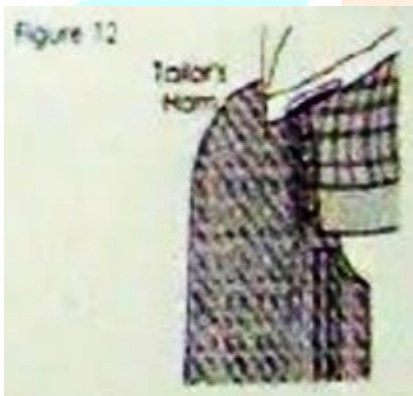
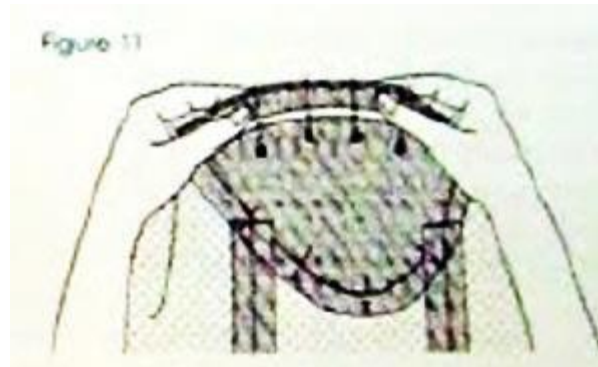

Steaming Cap Fullness

Figure 12

- Place sleeve cap over the end part of the ham or sleeve board. Pin to hold position.
- Steam the gathers with tip of the iron, press the gathered part of the seam. A hand (mitt) helps to smooth and shape the sleeve cap.
- Allow to dry before removing

Sew Sleeve to Armhole

Figure 13

- With right sides facing, pin or baste sleeve to armhole. Matching notches. Stitch.
- Pin header to sleeve cap and stitch 1/16" above the first row of gathers.
- Allow the header to fall down.

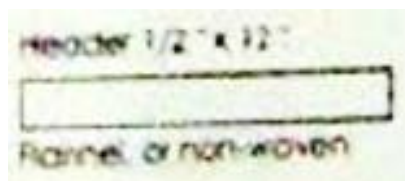
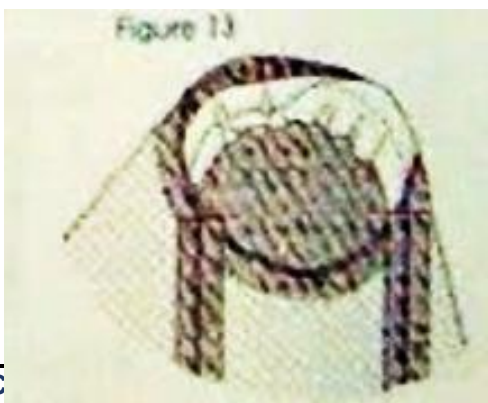

Attaching Shoulder Pad

Figure 14 a, b

Center the shoulder pad on shoulder line, extending to armhole, seam edge.

1. Catch stitch along the shoulder (a).
Fold jacket over the pad and tack at each end.
2. With shoulder pad pinned in place, machine stitch to armhole.

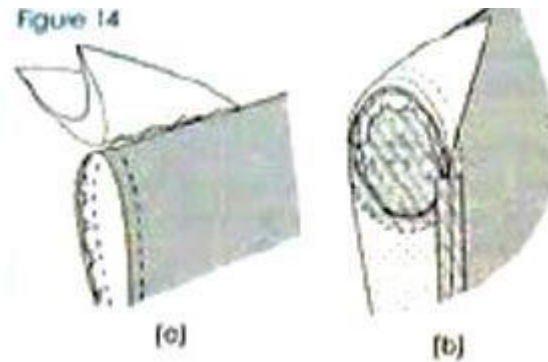

At this point, place garment on the form or model to analyze the sleeve.

Stitching Lining and Facing

Figure 15a, b, c

Stitch lining panels together. Fold action pleat and stitch across (c). Press lining seam open.

Facing: With right sides together, sew facing to lining (a), ending exactly at X point and back-stitch (b).

Flat-press facing seam

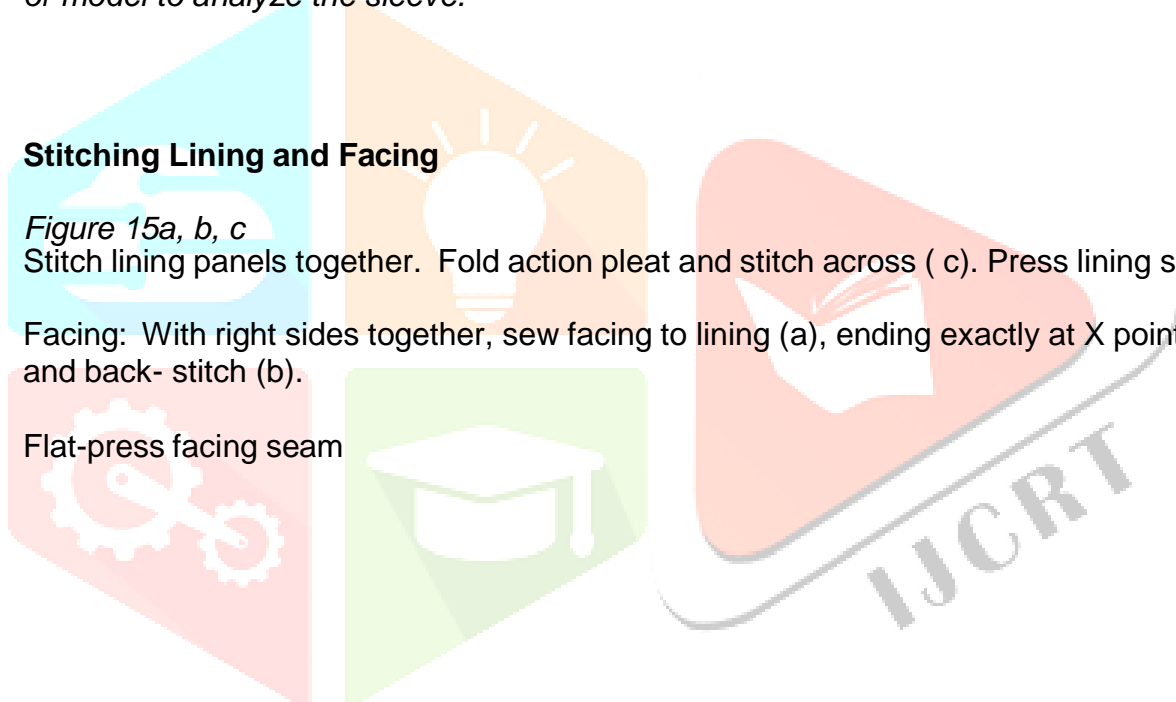

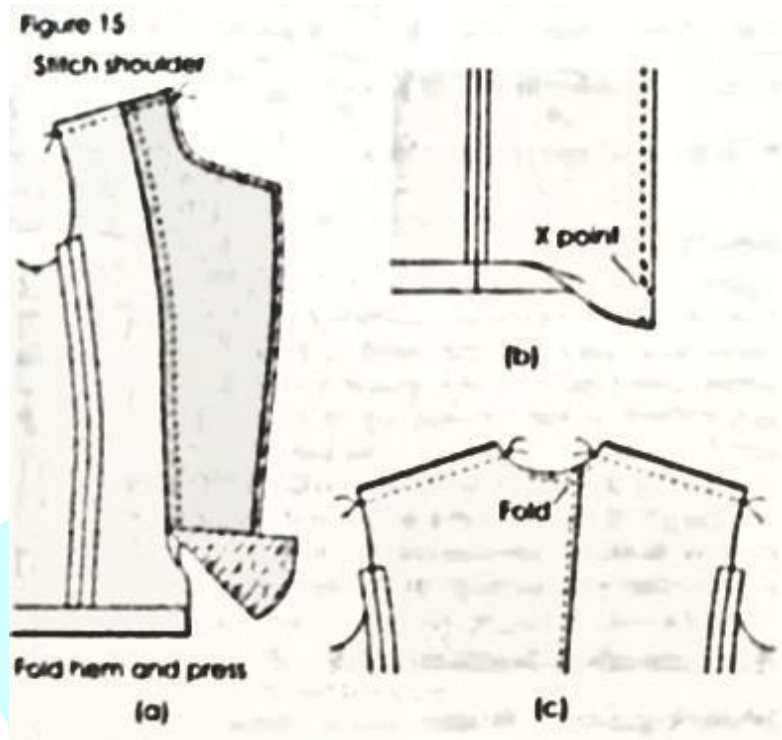

Sleeve Lining Stitched to Armhole

Figure 16 a, b

Two methods for attaching the sleeve:

1. Crimp sleeve cap as it is stitched to armhole, or run a gathering stitch at cap seam from notch to notch, and another row $\frac{1}{4}$ inch above (a).

Pull thread and spread gathers evenly. Sew underseams with one seam partially stitched. Press seams open (a).

2. Match notches, pin and stitch to armhole (b).

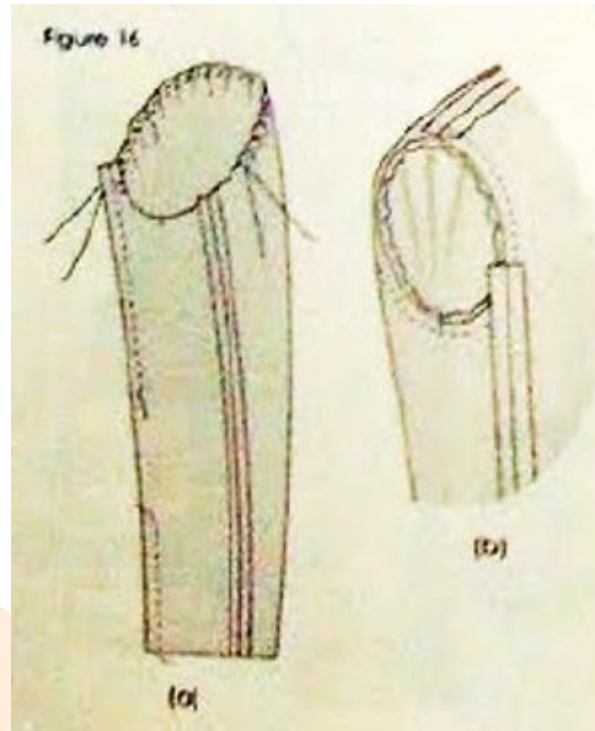

Two sides Back Vent

See Video and the sewing exercises for sewing

Sewing Lining to a Vent - YouTube.MP4

Stitch Collar to Jacket Neckline

Figure 17a, b

- With right sides of collar and lining together, pin and stitch upper collar to lining from center back neck to notch on the facing (a). Repeat on other side.
- With right sides of the collar and jacket together, pin and stitch the under collar to the jacket from center back neck to notch on the facing (b). Repeat on the other side.

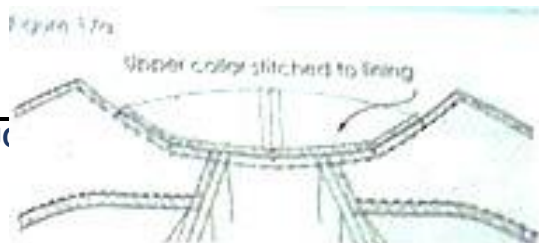

Figure 18

Press the collar's neckline seam open, and hand stitch both together to secure the collar to the garment



Sew Facing to the Jacket

Figure 19

- With right sides together, pin or baste facing to jacket. Start stitching 1/8 inch up on collar seam and end 1/2 inch from curve of hem at X, and backstitch. Repeat on other side of the jacket.

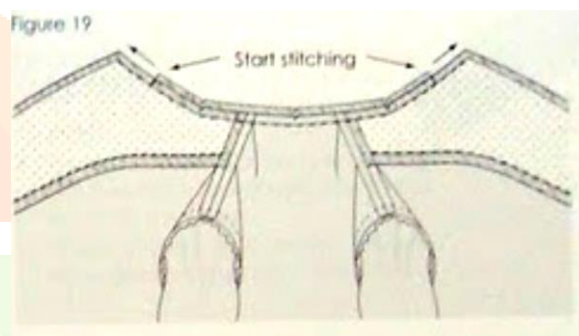
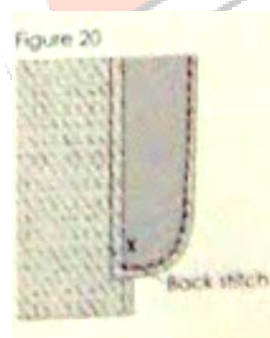
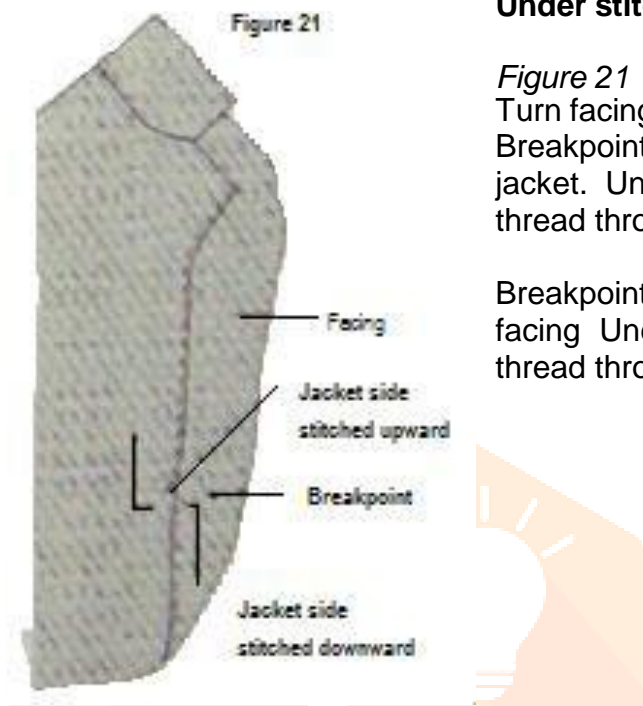

Figure 20

The illustration shows completion of facing





Under stitching

Figure 21

Turn facing to right side of the garment
Breakpoint to lapel, turn seam underneath toward jacket. Under stitch on jacket side. Pull hanging thread through and knot.

Breakpoint to hem, turn seam underneath toward facing Under stitch on facing side Pull hanging thread through and knot.

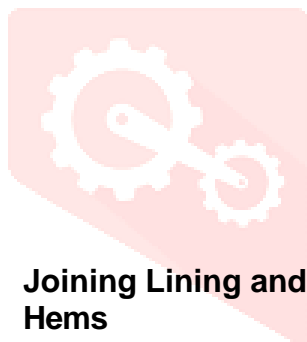

Joining Lining and Jacket Hems

Figure 22a to d

Facing will fold under as the lining is brought down to meet the hem of the jacket. Stitch the hemline together and continue just to the panel (a).

Fold the stitched hems upward from point X and in line with facing seam (b)

Figure 22

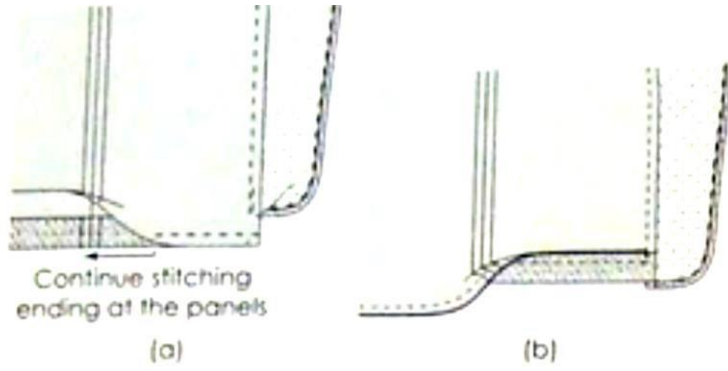

Securing the Hem with the Facing

Fold the facing under the lining and stitch to secure the hemline to the facing (c).



Figure 22d is a view of lining and jacket labeling lining sleeve B and the jacket sleeve A.

Aligning Seam Lines

Figure 23a to d

Bring sleeve lining (B) to jacket sleeve (A) with right sides facing.

Pin or baste the lining hem to jacket hem and check for correct alignment before stitching together. After stitching, fold at hemline and tack to secure at seams.

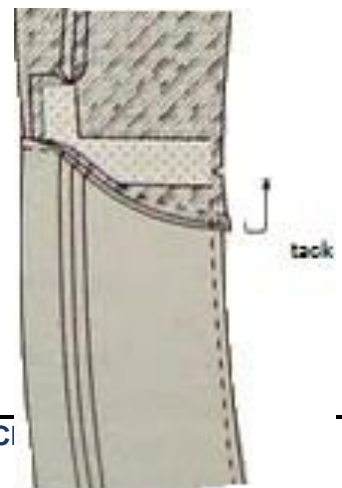
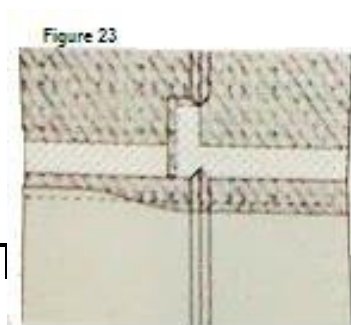

Pull Sleeves Through Opening

Figure 24

Slip arm into opening of the hemline and through lining of the sleeve; grab and pull both lining and jacket sleeves out at the hemline. Repeat on the other side of the jacket.

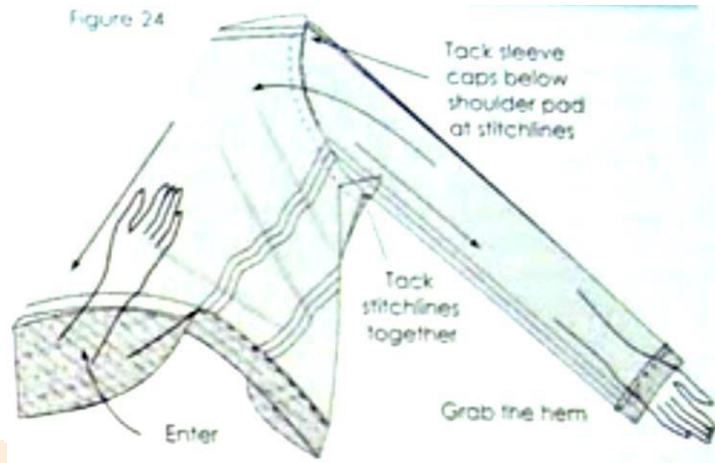

Tacking Armholes Together

To secure the lining to the jacket, go back into the garment through the lining and tack to 1/4" of the seams to join shoulder tips, panels and under center of the panels. Repeat for other sleeve.

Finishing the Hemline

Figure 25

- Lay jacket out flat; fold 1/2 inch seam allowance of the lining under and lay on top of the seam allowance of the jacket.
- Hand-stitch carefully to catch only one fiber at a time. Tack at center back seam to secure the lining.
- When finished, pull sleeves through, once again turning jacket right side out.

Figure 25

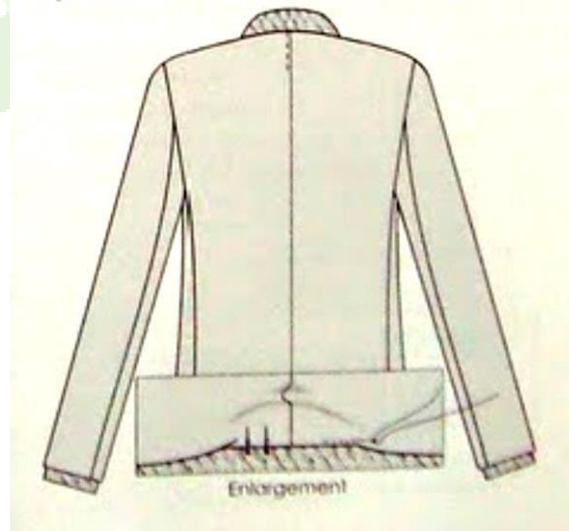

Figure 26



Stitch Buttons to Jacket

Figure 26

- Place buttons where marked on the garment.
- Place on the form or model for the test fit.

- After the fit and patterns have been corrected including the foundation pattern you are ready to cut the jacket in the design fabric.



Pocket Flap and Welt

Flap and welts are stitched to slits in the fabric for entry to the pocket pouch. The size of the pocket or welt should be in proportion to the jacket. If unsure, measure jacket pocket

Flaps and welts at department stores.

The construction of both is the same with this exception: flap stitches to top edge of the slit and welt to the bottom. A banding or piping can be attached to the flap, as illustrated.

Practice before stitching to the jacket

Figures 1a, b, c

Pocket Slits: Decide pocket and welt locations. Mark slit to desired length with tailor's chalk, on right side of the fabric. Mark center and draw perpendicular lines at each end (a).

Fusible interfacing. Cut fusible interfacing 1 inch longer than slit and 2" wider. Draw pencil lines through center length and mark middle of the interfacing. Draw angle lines, as shown. Fuse to the back side, matching lines of the front slit (b)

Figure 1c is the right side showing the image of fused interfacing.

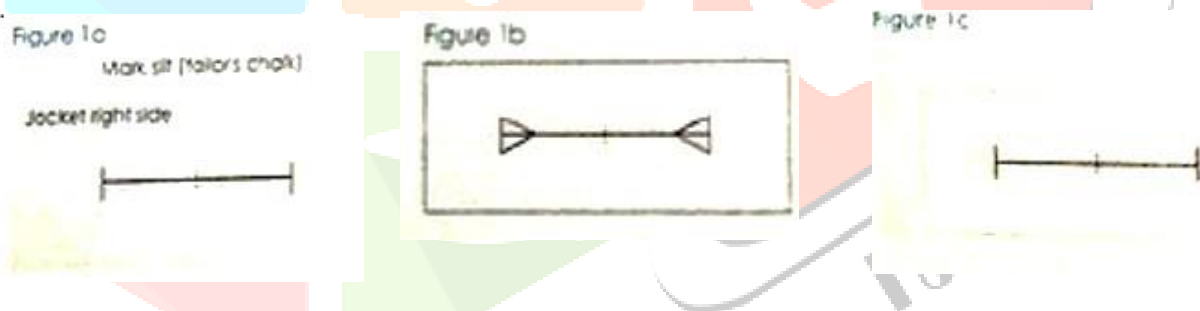

Figure 2

Flap and welt: Make the flap and welt patterns, add $\frac{1}{4}$ " seams and cut in self and lining backing. Mark centers.

Fusible interfacing: Cut from traced copies of the flap and welt. Remove seams and fuse to wrong side.

Finish: Stitch, press, clean seam, trim edges, and mark centers.

Banding: Cut 2 strips: length of pocket plus 1' and width slightly more than $\frac{1}{2}$ ", Press on fold and mark centers.

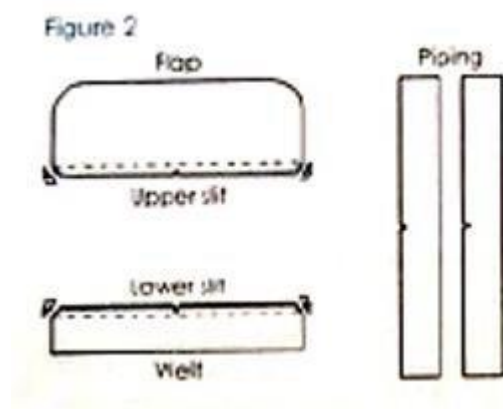

Figures 3a,b

Draft two pocket lining pattern sections 1" wider than flap or welt. Choose length and extend each as shown.

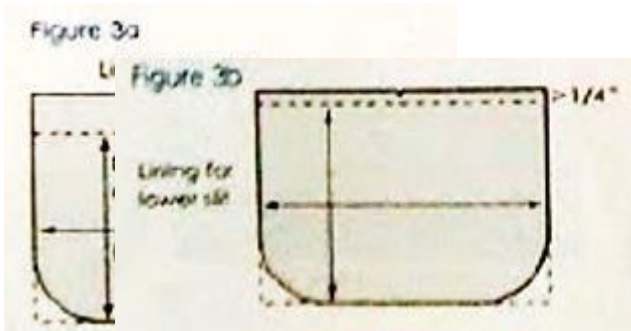

Upper Part of the Slit

Figure 4

Banding: Center on the slit line. The ends will extend 1/2", stitch 1/8" starting 1/2" from end and stopping 1/2" from the end.

Flap: Center the flap on top of banding with raw edges matching. Sew 1/4" seam.

Lining: Center lining on the top. Stitch 1/4" starting 1/2" from the end and stopping 1/2" from other end, and back stitch.

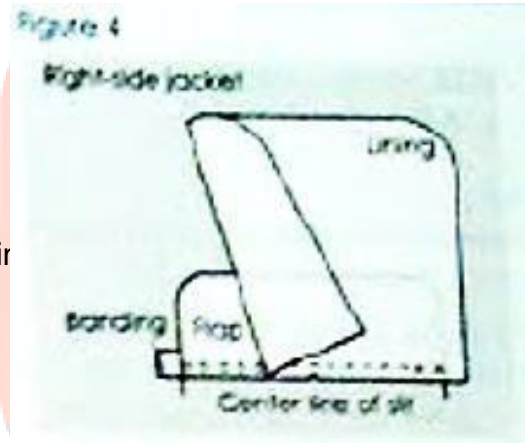

Lower Part of the Slit

Figure 5

- Center banding on slit line and stitch 1/8" seam, starting and ending 1/2" from the ends.
- Center lining on slit line, and stitch 1/4" seam, starting and ending 1/2" from the ends, and back-stitch

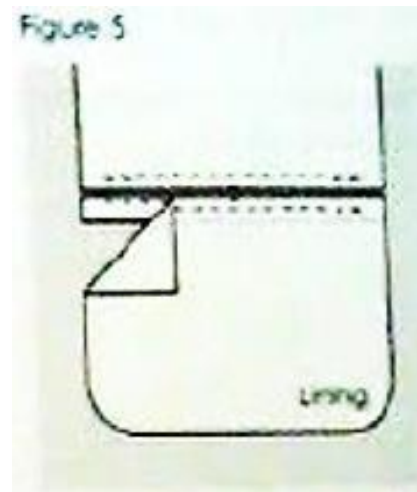
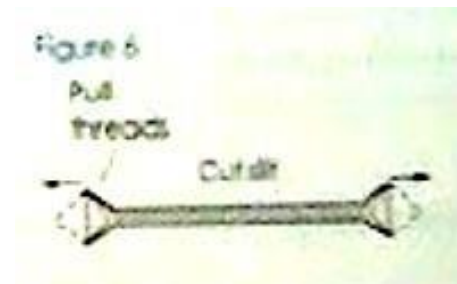
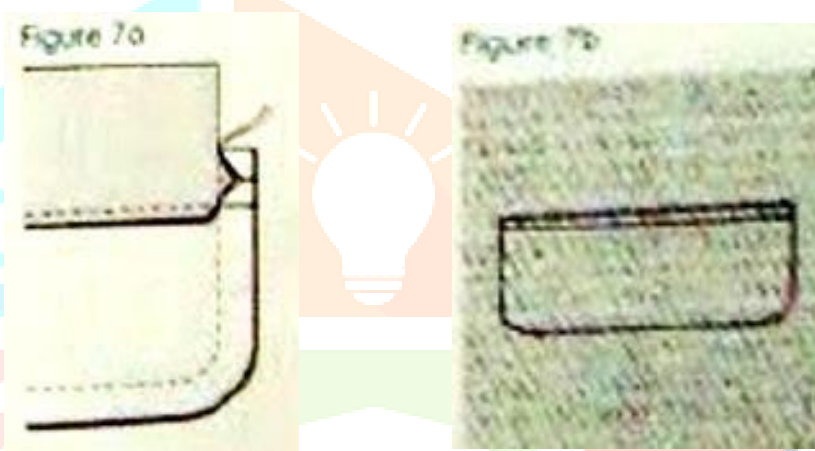

Figure 6

- Turn over to wrong side. Cut through center line carefully cut angle lines to each corner.
- Gently push the angles to right side.

Figure 7a, b
Finishing the pocket

- Fold jacket upward
- Make sure the triangles are out and clear.
- Stitch across the triangle twice.



Welt

Figures 8a, b, c

Center welt on the bottom slit and stitch $\frac{1}{8}$ " (a).

Center the lining and stitch $\frac{1}{4}$ ", ending $\frac{1}{2}$ " from the ends, and back-stitch (b).

Upper slit: Center lining and stitch $\frac{1}{4}$ " starting and ending $\frac{1}{2}$ " from each end and back-stitch (b).

Pull welt through to right side. Pin lining and stitch together. The welt is hand stitched at each side securing to the jacket (c)

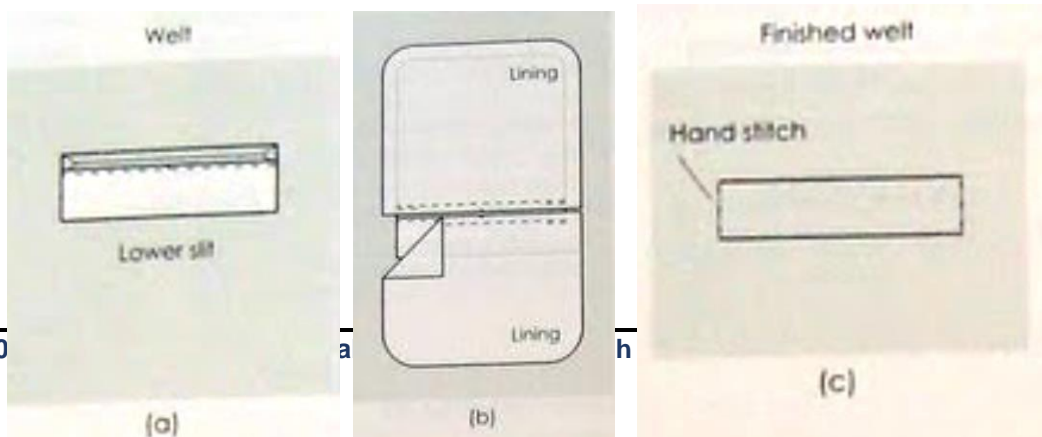

OPERATION SHEET 12	MAKING INSERTED SEAM POCKETS
---------------------------	-------------------------------------

PURPOSE:

The entry of the pocket is an angle line in from the side waist. It is usually placed as front pockets for pants.

MATERIALS, TOOLS & EQUIPMENT NEEDED:

Qty	Unit	Description
1	Pair	Pocket facing, left and right
1	Pair	Pouch lining, left and right
1	Pair	Backing, left and right
1	Pair	Full lining support
1	Pair	scissors
1	Unit	Pressing equipment or flat iron with presser's ham
1	Pair	Front pants/ skirt section

Pocket Parts

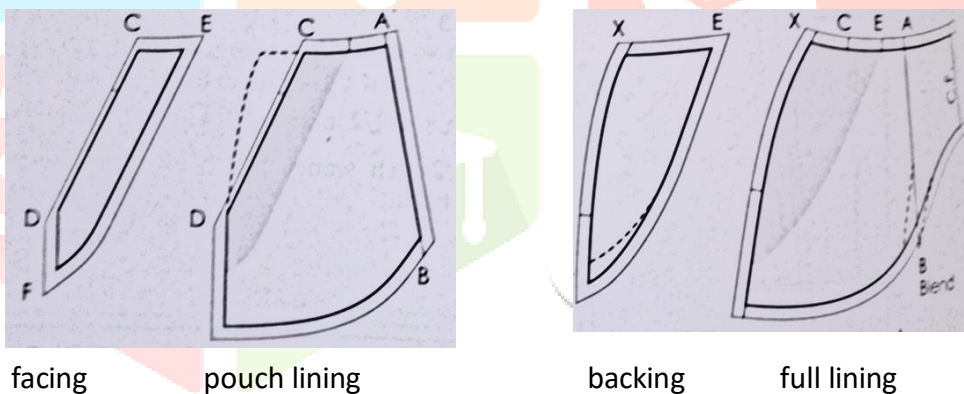

PROCEDURE:

1. With the fabric right sides up, stitch the facing on the pouch lining and the backing on the full lining. Finish the raw seams at the A-B seam and the center front seam.

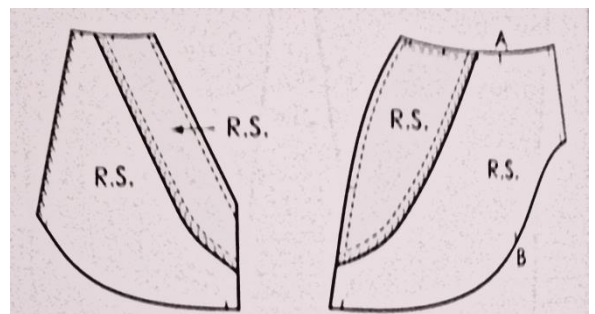

2. Stitch the pocket pouch to the entry of the pant with the right side facing. Fold the pocket pouch over and edge stitch the facing.

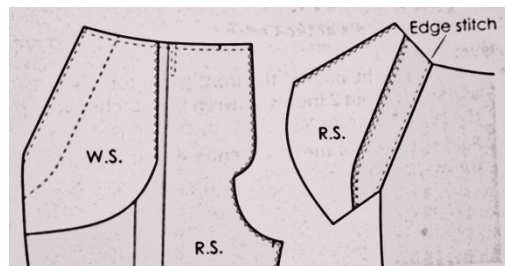

3. With the right side of the pouch and full lining facing, pin pouch to the A-B notches and stitch. Finish the raw seams together along the bottom edge of the pocket.

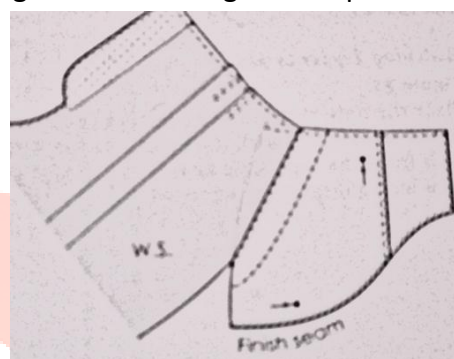
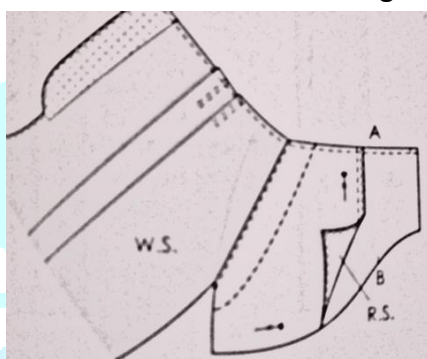

4. Pin the pocket to the pants and staystitch across the waistline. Finish the outseams of the front pant and pocket. The lining is caught in the stitch of the zipper.

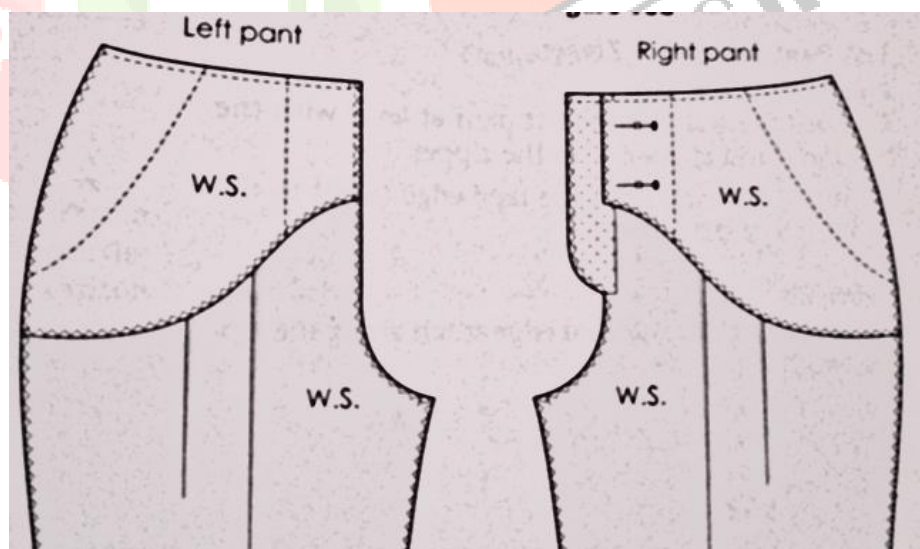

OPERATION SHEET 13

MAKING FRONT ZIPPER FLY PLACKET

PURPOSE:

To make front zipper fly placket for trouser according to quality standards and specifications

MATERIALS, TOOLS & EQUIPMENT NEEDED:

Qty	Unit	Description
1	Piece	Zipper fly
1	Piece	shield
1	Piece	zipper
1	Pair	Full lining support
1	Pair	scissors
1	Unit	Pressing equipment or flat iron with presser's ham
1	Pair	Front pants section

PROCEDURE:

1. Stitch fly to the right pant, right sides together from the center waist down to the notch. Press seams towards fly then understitch fly.

Note: For men fly is attach to the left pant while shield is on right pant.

2. Place right sides of the front pants together and stitch about 2 inches between the notches at the curve of the crotch. Fold right side of fly at the center line and press to wrong side.

3. Fold the wrong side of the shield together and finish the raw seam. Place the right side of the zipper 1/8" above the shield and aligned with the finished edge. Stitch 1/8" from the tape edge of the zipper and another 1/16" along zipper teeth.

4. Place the waist of the left pant at level with the shield and aligned with zipper. Stitch 3/8" from the tape edge (waist to the length of the zipper). Fold pant to right side and edge stitch along the zipper length.

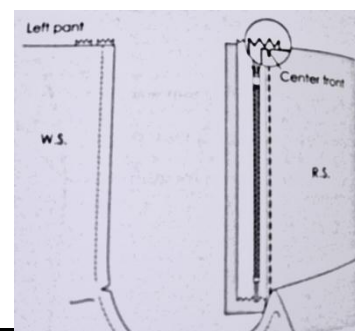
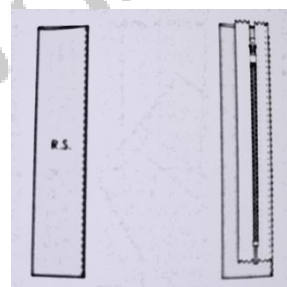
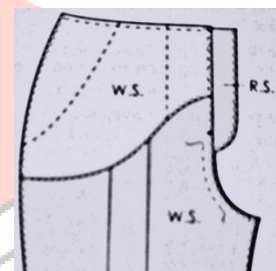

- Place fold of the fly at center front notch of the left pant. Pin or baste and catch only the pant. Place right pant under left pant except for the fly. Pin shield away and stitch zipper to fly.

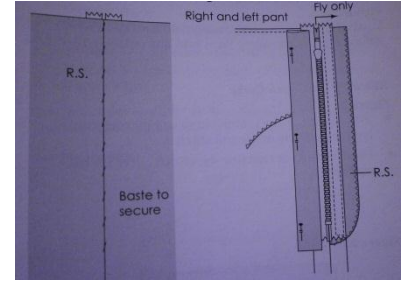

- Unfold the right pant. Thread-line the edge of the fly through the right side pant as sewing guide for topstitching.

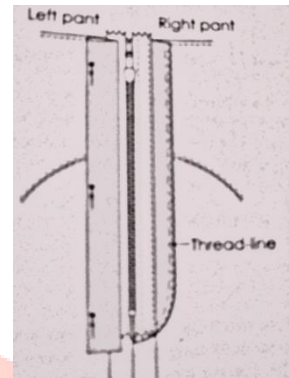

- Place the pant right side up. Stitch $\frac{1}{4}$ " in from the thread-line guide. If two rows of stitching are desired, stitch $\frac{1}{4}$ " from the first stitch. Back stitch at the end of the curve to secure.



OPERATION SHEET 14	ATTACHING WAISTBAND
---------------------------	----------------------------

PURPOSE:

To secure the trouser components in place and snugly fit the body

CONDITIONS:

Prepare belt loops before stitching waistband to pant if the design calls for it to be inserted along the waistline of pants.

MATERIALS, TOOLS & EQUIPMENT NEEDED:

Qty	Unit	Description
1	Piece	waistband
1	Lot	pins
1	Pair	scissors
1	Unit	Lockstitch sewing machine
1	Unit	Overlock/serger sewing machine
1	Unit	Pressing equipment or flat iron
1	Pair	Front pants section with placket

PROCEDURE:

1. Fold ½-inch seam and press (Method 1) or overlock/serge top edge (Method 2). Pin waistband ½ inch past the front and back centers and stitch.

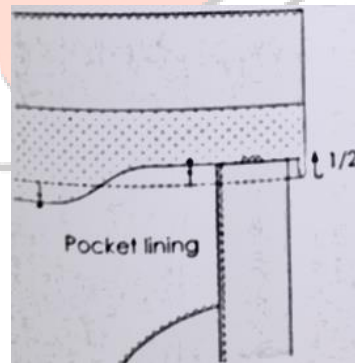
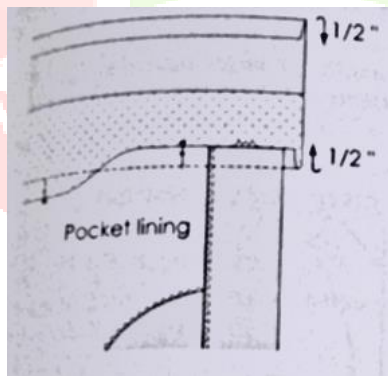

2. Fold waistband according to the pattern, pin together and stitch (backstitch) at each end.

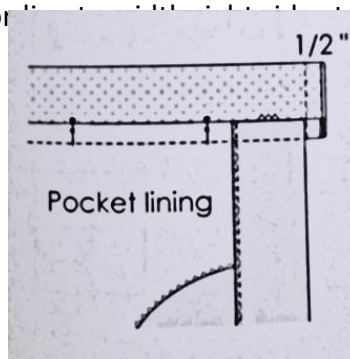

3. Turn waistband to right side. Fold seam under and pin (Method 1) or pin finished edge $\frac{1}{2}$ inch below seam (Method 2). "Stitch-in-the-ditch" on the right side, catching the back waistband.

Method 1

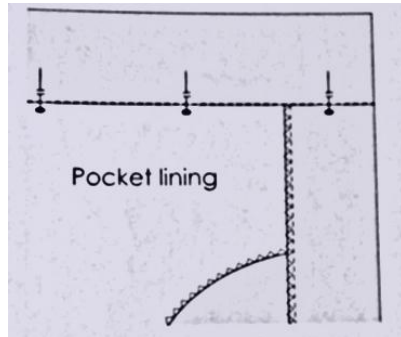

Method 2

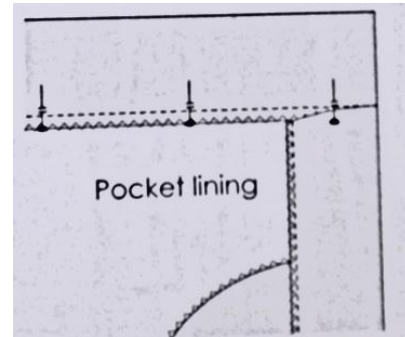

OPERATION SHEET 15

PREPARING AND ATTACHING BELT LOOPS

PURPOSE:

Belt loops are used to hold the belt in place especially when the waistline needs adjustments to fit snugly on the body.

MATERIALS, TOOLS & EQUIPMENT NEEDED:

Qty	Unit	Description
1	Piece	Cut fabric for belt loop
1	Unit	Lockstitch sewing machine
1	Pair	scissors
1	Unit	Pressing equipment or flat iron
1	Piece	Pants

PROCEDURE:**A. Preparation**

1. Fold the loop at the center right sides together and stitch 1/8 inch seams.
2. Turn the loop to right side, center the seam and press.
3. Edge stitch each side of the loop.
4. Cut five to six loops into 2 ¼ inch lengths.

B. Attaching Belt Loops

1. Stitch one end of the loop on the right side of the waist of the pants
2. Stitch/Backstitch the loop ¼ inch below the waist (Figure 1).
3. After the loop is attached, the top of the loop is folded ¼ inch and stitched to the top of the waistband (Figure 2).

Note: Place a loop between pleats, at the pockets and darts at the back or center back.

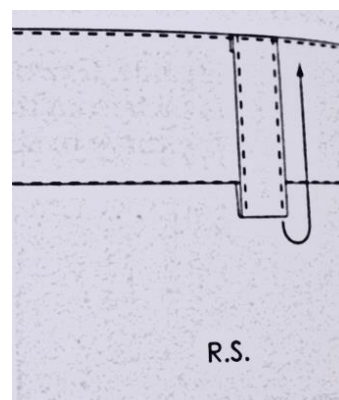
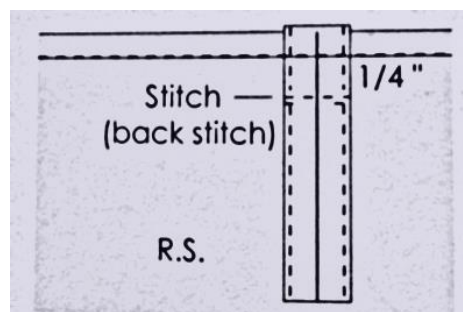

Figure 1

Figure 2



OPERATION SHEET 16

MAKING BUTTONHOLES USING BUTTONHOLE ATTACHMENT

PURPOSE:

Buttonholes often have a **bar** of stitches on either end of it. This is a row of perpendicular hand or machine stitching to reinforce the raw edges of the fabric, and to prevent it from fraying.

CONDITIONS/ SITUATIONS FOR OPERATIONS:

It is also important to mark your buttonholes on your fabric before you start. You can use your test buttonhole as a guide for placement. Additionally, you can use this formula for determining how long your buttonhole should be: Diameter of button + $\frac{1}{4}$ ".

MATERIALS, TOOLS & EQUIPMENT NEEDED:

Qty	Unit	Description
1	Set	Fabric/project that needs buttonhole
1	Unit	Lockstitch sewing machine with buttonhole foot or buttonholing machine
1	Pair	Thread match color with fabric
1	Pc	Button of choice
1	Piece	Tape measure or ruler
1	Lot	Pins

PROCEDURE:

This is a buttonhole foot for making an automatic buttonhole. As you can see, it is much different from a traditional sewing machine foot. This foot works with a sensor on your sewing machine so that it makes the exact size buttonhole for the button you are using. The button is placed in the slot at the back of the foot, and the foot adjusts to the size of the button. There is a sensor on the machine which works with the foot to create a buttonhole the appropriate size. This is an incredibly easy way to make a buttonhole! There is one down-side, however. It works best with flat buttons. If you have a button with a raised surface, or a button that is not round, this option won't work as well. In that case, it is best to go with the four-step buttonhole, or a manual buttonhole.

1. Carefully mark the buttonhole(s) on your fabric. Use the following formula for determining size: Diameter of button + $\frac{1}{4}$ ".
2. Place the button in the sensor slot of the buttonhole foot. Pull down the buttonhole sensor. Attach the foot to the machine.

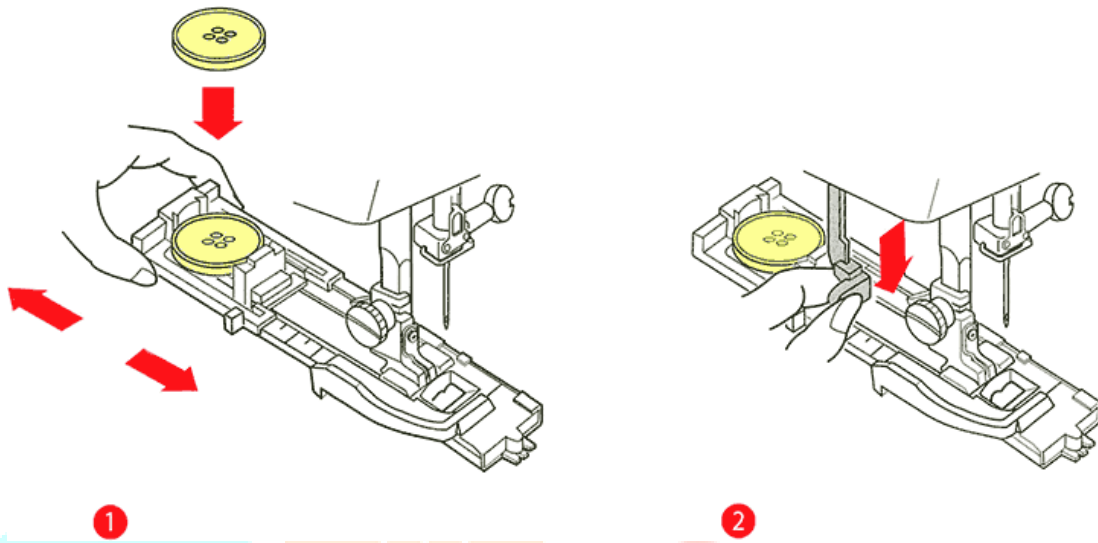

3. Select a buttonhole stitch from the stitches available on your machine.
4. Place the fabric with the buttonhole mark under the needle. Align the front/top mark with the needle hole of the foot. Lower the needle into the fabric and adjust placement if necessary.

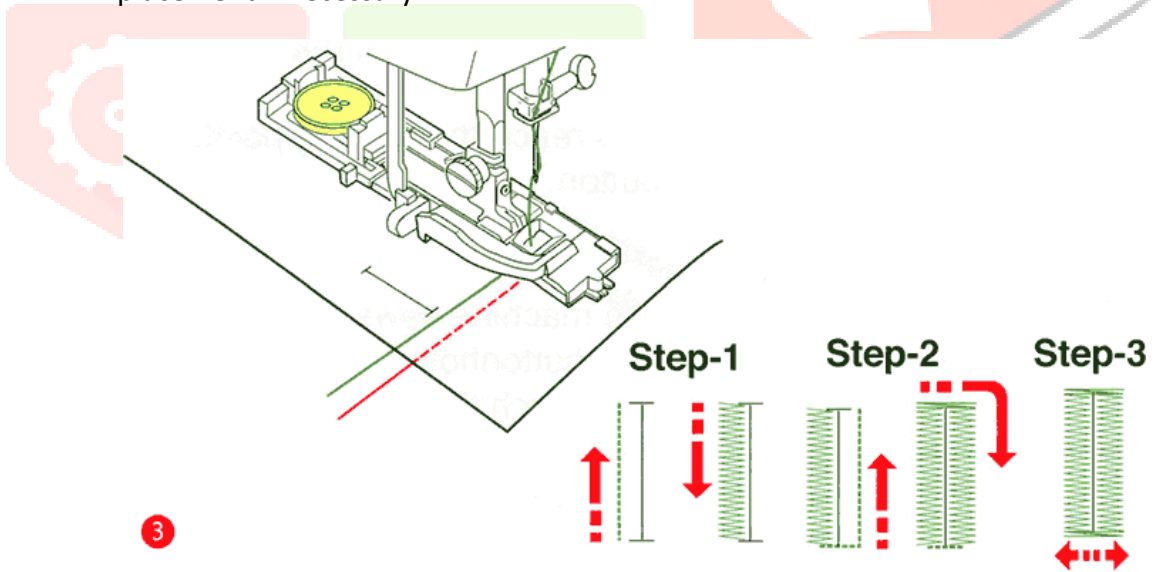

5. Start the machine and sew the buttonhole. The machine will sew the front bartack of the buttonhole, then down the left side, then return to the starting point and sew the right side and the back bartack.



6. The machine will stop automatically at the end of the buttonhole.



7. Remove the fabric from the machine.

8. Open the buttonhole using small sharp scissors or a seam ripper. Be careful! You can place a pin in the end of the buttonhole to be sure you don't accidentally cut the bartack stitches.



OPERATION SHEET18**TRIMMING EXCESS THREADS****Purpose:**

Trimmed excess thread in finished garment means neat, orderly and well-constructed garment.

Conditions/ Situations:

Hang garments of the same kind. Provide spaces in between hanged garments to preserve its professional look.

1. Reverse and hang finished garment in an airy place.
2. Use cloth hangers in hanging.
3. Don't hang garments under the sun. Exposure to sunlight will fade the garment easily.
4. Press garment before hanging.
5. Avoid over-crowding in hanging to avoid wrinkles on the different parts.

Materials, Tools and Equipment

- Trimming tools
- Hanger

Procedures**A. Finished Jacket/Coat**

1. Invert the garment.
2. Inspect hanging threads on the different parts.
3. Cut excess threads starting from top to bottom.
 - neckline, facing, collars
 - shoulder seams and paddings
 - armhole seams and seam finished
 - sleeve hems
 - front darts/back darts
 - blouse bottom hems
4. Invert jacket/coat right out. Trim excess thread on
 - Plackets
 - button attachment
 - other trimmings/accents

B. Long Pants

1. Turn garment wrong side out.
2. Inspect hanging excess thread.
3. Cut excess thread from top to bottom.
 - waistline
 - hook and eye
 - ply
 - pockets
 - inseams
 - out seams
 - bottom hem
4. Turn pants right side out. trim excess threads on:
 - waist band
 - placket
 - pocket mouth
 - side seams
 - bottom hem

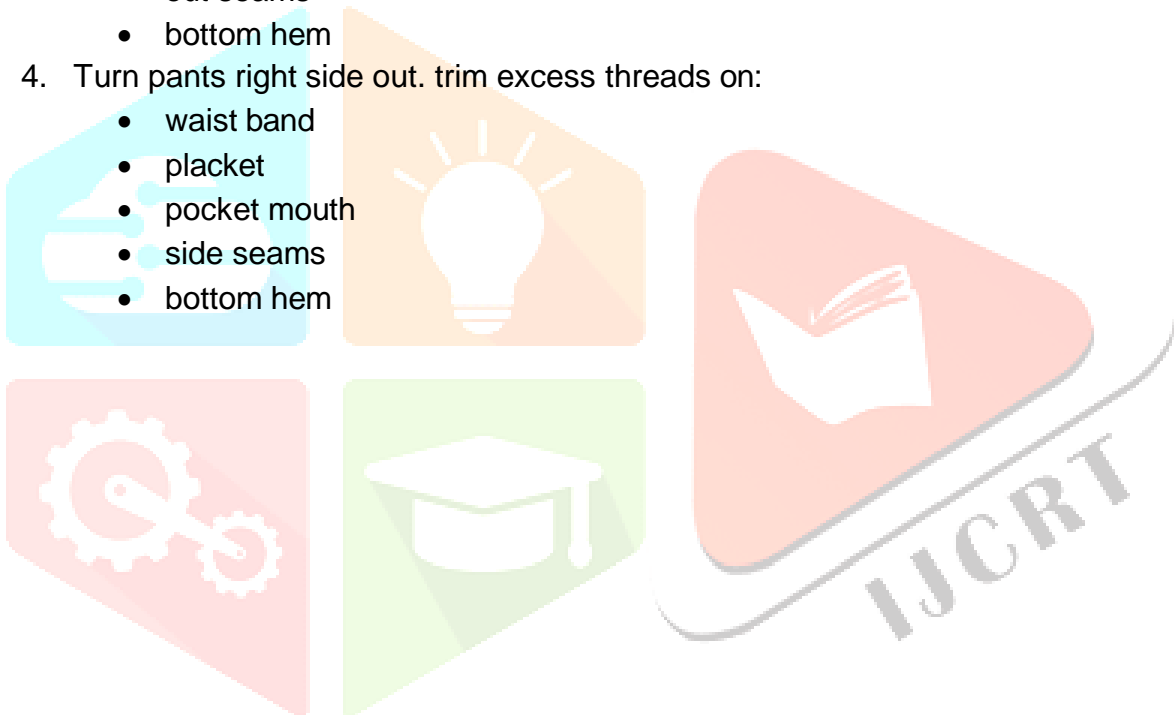

INFORMATION SHEET1**GENERAL GUIDELINES FOR PRESSING
DURING THE CONSTRUCTION PROCESS**

One of the real secrets to good costume construction is proper pressing. Pressing must be done as the construction progresses, it cannot be left to the last, as no amount of final pressing will make up for step by step pressing. Careful, thorough pressing during each construction process will result in professional looking garments that require only a minor touch up when completed.

**GENERAL GUIDELINES FOR PRESSING DURING THE CONSTRUCTION
PROCESS**

1. Pressing is not Ironing. Pressing is the process of lifting the iron and setting it down again in the proper position. Pressing can accomplish things a needle and thread can't
2. Always test a scrap of fabric or an inconspicuous garment area to determine the best technique for pressing the fabric. Test a scrap large enough to allow for comparison between the pressed and unpressed fabric
3. Keep an assortment of pressing tools and aids available at all times. Know how to use them. These tools were created to help achieve professional results, but they don't do much good left on the ironing table unused
4. Check the fabric's reaction to steam and moisture. Both should be used properly or water or scorch marks will be present on the fabric
5. Press with the grain of the fabric whenever possible and be careful to not stretch edges or curves by pulling the fabric
6. Press all seams open first, then press in the stated direction for proper garment construction
7. Press all seams and construction details on the wrong side first, then press the right side of the garment. Test the fabric to see that the right side can be pressed.
8. Use the point of the iron to open seams before reaching them with the bulk of the iron
9. Always press seams and darts BEFORE they are attached to other garment seams, this helps reduce bulk
10. Never press any sharp creases (except pleats) in the garment before the final fitting is done.
11. Above all, know your fabric and do not OVERPRESS

PRESSING TECHNIQUES:

Finger pressing is using the heat of the body to press or crease small areas of fabric. Finger pressing often works wonders on stubborn seams before you press with the iron

Favoring is when you roll one garment edge over another just slightly to conceal the seam. Favoring is used extensively in tailoring and can make any collar; waist band, etc. look much more professional.

Final Pressing is the last pressing procedure on a garment and should be a mere touch-up. The roll of collars and lapels need to be 'set' with a small amount of steam and heat. Most final pressing is done with the iron held just above the surface of the fabric

Steaming is done for maintenance or during the construction process when the weight of the iron might mark the garment. Hold the iron just above the fabric, not more than 1", and depress the steam button.

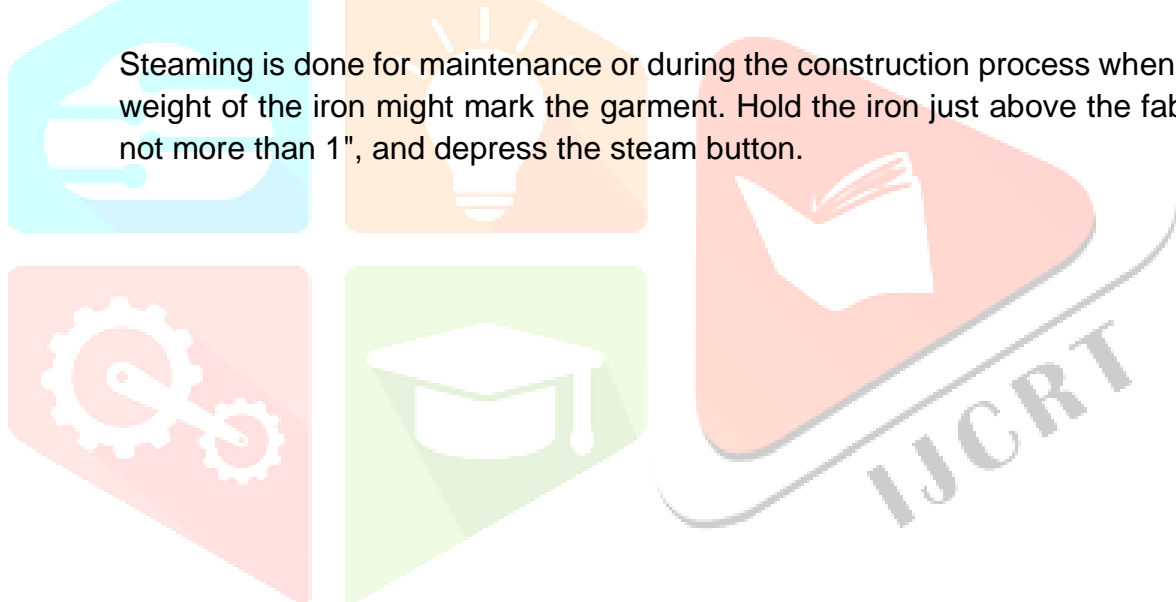

OPERATION SHEET19**IRONING/ PRESSING TROUSERS**

Use these ironing tips to press pants and trousers to creased perfection.

- Begin with the waistband and inseam area, then pockets and cuffs.
- Pull waistband on pointy end of the board, as if you're "dressing" the ironing board. Iron upper-front part of the pants, including the waistband.
- Place pants parallel to ironing board lengthwise so both legs are facing the same direction. Iron each leg by moving the iron back and forth along the pant leg.



- Take cuff of the leg and bring it over towards the waistband to iron the inner part of the leg. Repeat these 2 steps for the second leg.

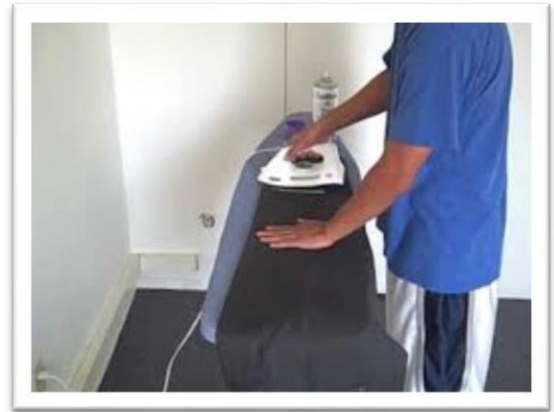

- Hang pants up when ironing is completed, either by the waistband or by the cuffs, or on a shirt hanger, by folding them in half and maintaining the creases.

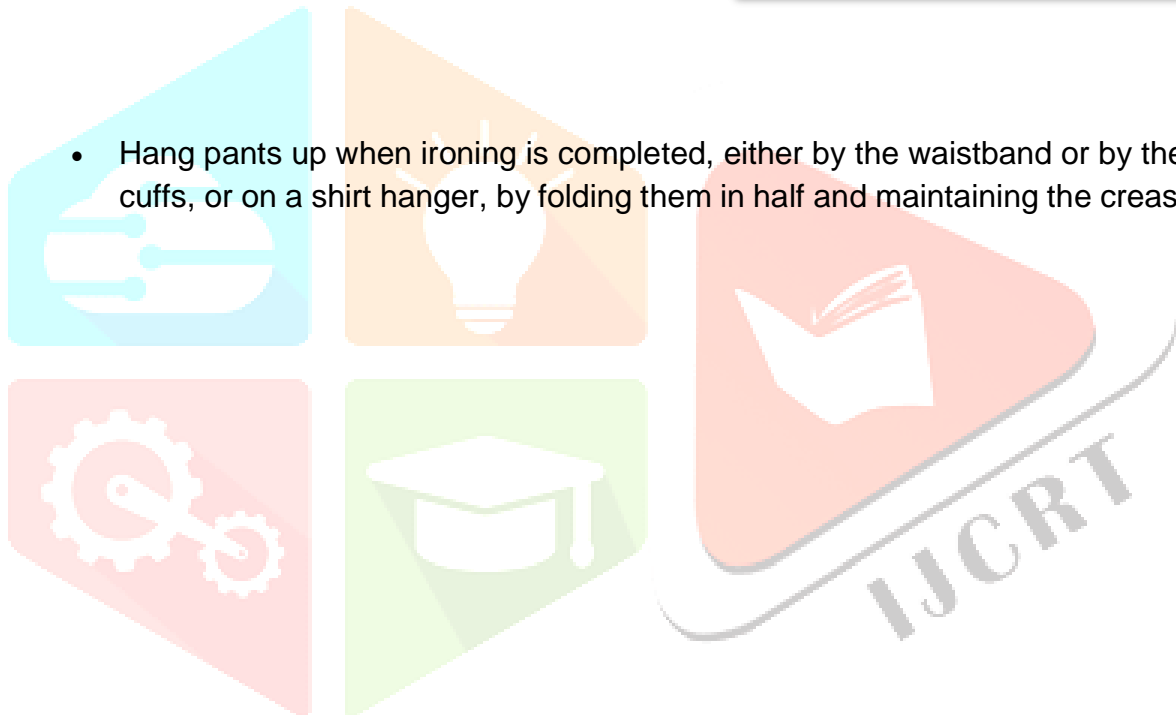

OPERATION SHEET 20

PRESSING/IRONING COAT

PROCEDURE:

1. **Set up the ironing board.** If you don't have one, use a bath towel folded in half; lay it on a flat surface that will not be damaged by heat.

2. **Check the care label on your jacket for care instructions.** The most important part is to know the fibre content. If it's a linen jacket, the iron can be hot and you will need steam. If it's wool or wool blend then warm with steam is okay. If synthetic (for example, polyester/nylon), use a cooler setting without steam.



3. **Check the base of the iron is clean so that no residue will adhere to your suit fabric.** If it needs a clean, use wire wool and wipe with a damp cloth.

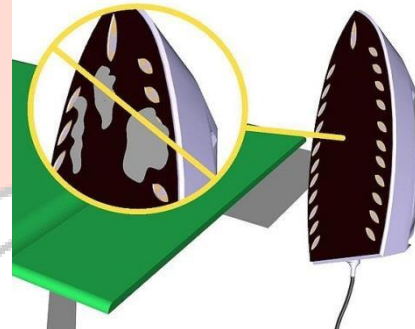

4. **Set up for steam, if desired.** If you are using steam (you will get a better result), find a small jug to fill the reservoir in the iron with water.

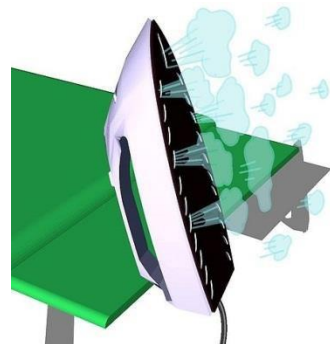

5. **Plug in your iron, set to correct temperature.** One dot is cool, 2 dots warm and 3 dots is hot.

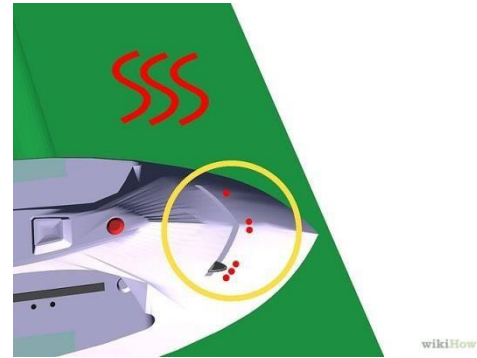

6. **Wait whilst it heats up.** Do not start ironing before, or water will leak out and may mark the fabric.



7. **Take the jacket and lay it flat on the board.** Test the iron heat first on an inside area of the fabric, close to the hem, so if for some reason the iron still leaks or marks it, it is not in a visible place. Adjust the settings if necessary and continue carefully.

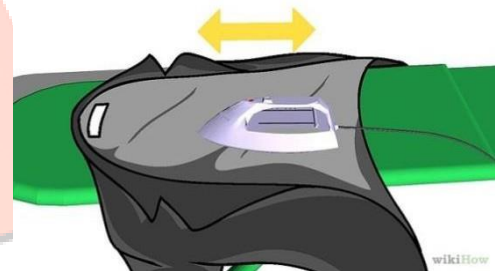

8. **Start ironing the jacket body.** Do not drag the iron but lift it and gently press down.

- Iron lightly and smoothly over the back panel on the lining, not the face of the fabric.
- Lay a clean tea towel over the face of the fabric and press through that. If the material has any special finish on it, this will also prevent a shiny look, which once pressed in will not come out!
- Take care not to over-press, especially on hems.
- Turn around and press the front panels, taking care of the lapel area.
- Iron under the lapels so not to squash them flat.



9. **Tackle the sleeves (the trickiest part).** One tip is to roll a hand towel or t-shirt and stuff it up the sleeve to get a soft finish, as you do not want a hard line down the arm. You can also blow steam through; just be careful not to have your hand in the way.

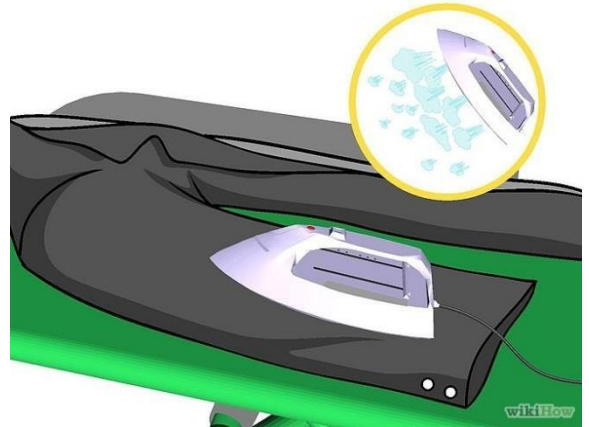

10. **As soon as you are finished, hang your neatly pressed and steamed jacket on a well-shaped hanger.** Use one with shoulders and padding if possible, but a wire one is better than nothing. Allow it to cool hanging.

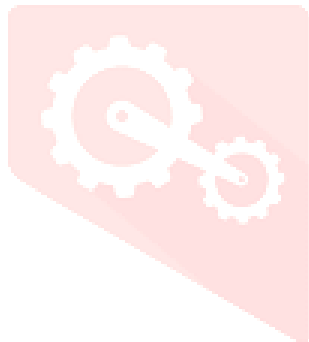
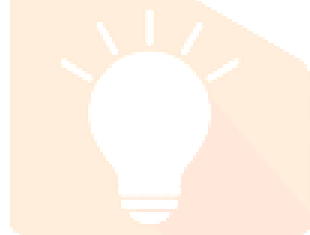

OPERATION SHEET 21	FOLDING, PACKING and PACKAGING MEN'S SUIT
--------------------	---

How to Fold And Pack Pants:

Step 1 – Lay the pants out.

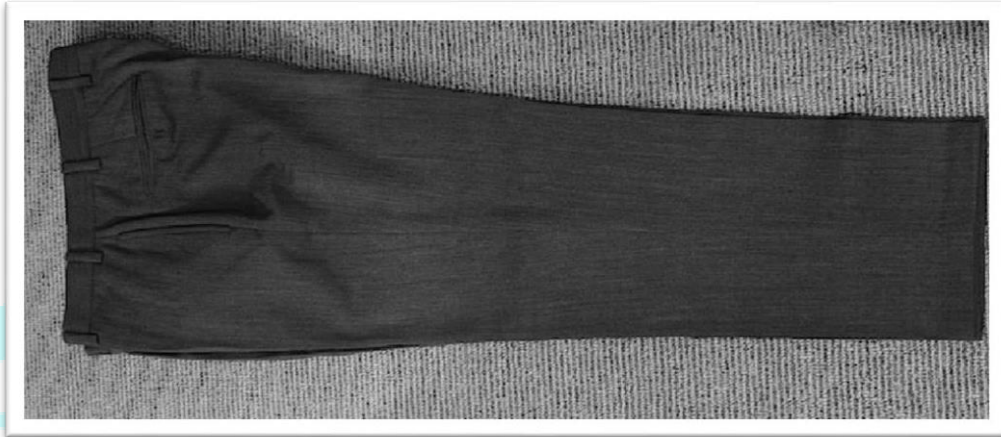

Step 2 – Fold the pants in half.



Step 3 – Fold the pants in half again and place in the fold of the jacket



How To Fold And Pack A Suit Jacket:

Step 1 – Place your hands in the shoulders of your jacket with the jacket facing you

Step 2 & 3– Fold the jacket in half lengthwise. In other words, put the two shoulders together.

Step 4-6– This is the trickiest step. Fold one of the shoulders inside out over the other so that you now have the lining of the jacket facing outward.

Step 7– Fold the jacket in half, but this time fold the shoulders down to the end of the jacket.

Step 8 – Place the folded pants in the fold of the jacket. This will help protect the pants and create a bit of a cushion for the jacket which should help fend off some creasing along the waist of the jacket.



Packaging Men's Coat and Trouser

