



Study of daylight envelope as an urban planning tool in determining building height to street width (H/W) ratios in Residential Zone of Guwahati city

¹ Amal Barman, ² Dr. Madhumita Roy, ³ Dr. Arpan Dasgupta

¹Research Scholar, ²Professor, ³Associate Professor

¹Department of Architecture,

¹Jadavpur University, Kolkata, India

Abstract: This study discusses the construction of daylight envelope analysing the available daylight access in residential buildings of Guwahati city and reviews most common daylight planning tools to develop a method to determine building height to street width ratios with the actual illumination level inside urban residential buildings. Four daylight planning tools for site planning and urban design decisions are studied and analysed their character. FAR allowed by generated building envelop will be calculated for each tool and compared. All the tools specified a building height to street width (H/W) ratio, but none suggested a basis for its proportion. This study initiates to determine H/W ratio with the average and minimum daylight factor within a building. Result of this study, plotting H/W ratio against average daylight factor can be used as a preliminary urban design tool to determine the Zoning restrictions especially in the residential zone of GMDA area while protecting daylight access to the adjacent building.

Index Terms - Daylight envelope, Sky view angle, Solar envelope, H/W ratio

1. INTRODUCTION

Daylight access is a primary necessity for the use of daylight in buildings. Zoning laws, the requirement of setbacks in low-density areas and height restriction in urban areas, have been used to address for both the need for the value of access to light and air. With increasing height building and density reduces light levels towards the street. The levels of available daylight in buildings are affected by various factors such as latitude, climate, relation to adjacent obstructions and reflectivity of the adjacent surfaces.

Side lighting, top lighting and atria lighting are the three major daylight strategies which are commonly used for daylight access. Each strategy has a unique impact on daylight access. Beyond the general factors impacting on daylight planning, design strategy used in a group of buildings can have a greater impact on the overall form of buildings. A framework to support particular building forms could theoretically be matched with an appropriate day lighting strategy. For example, if a side lighted building requires a particular angle to ensure adequate day lighting access to the adjacent building block, then block dimensions could be designed as multiple of a typical building thickness plus the space between buildings.

The organisation of buildings, streets and open spaces, particularly in higher density areas, prevent access to sun, wind and light resources to adjacent buildings or plots. The regulations of the building envelope are the most important factor to ensure access to sun, wind and light in every building. Daylight envelope is a technique which can be used to shape and space between buildings to assure adequate daylight access to the street and adjacent buildings. Architects and planners can use these daylight envelope criteria to shape the building form while ensuring predictable daylight performance inside the building. There are many planning tools which are available for construction of daylight envelope at the site scale. All of these tools are justifiable and appropriate in daylight access planning in urban scale also and can be used effectively to frame development control rules of GMDA.

2. DAYLIGHT ENVELOP CRITERIA

2.1 Construction of Daylight Envelop

The daylight envelope is the maximum developable volume that can be built in a given site while protecting daylight access to neighbouring building or sites. It offers prescriptive development control. As a development technique, the daylight envelope tends to produce street-oriented buildings of high ground coverage, and when the site is fully developed, stepped up building forms.

In higher density areas of urban situations, as street wall height increases daylight levels are reduced. Daylight available to rooms facing the street is dependent on factors such as the ratio of building height to the width of the street (H/W ratio), the reflectivity of the exterior walls, and amount of the glazing surfaces in the wall. High street walls block more view of the sky from windows. So, windows in lower rooms are mostly illuminated by reflected light. Higher wall reflectance increases light level near the street. Table.1 shows the required DF of 26 deg. North latitude of Guwahati.

Table 1: Daylight Factor, H/W ratio and Minimum spacing angle

Latitude	Required Daylight factor	H/W range	Minimum spacing angle			% of annual hours 9.00 AM – 5.00PM	Remarks
			low	medium	high		
26 deg.	1.25	1.6-2.0	55	67.5	----	85%	Large window NR

The amount of light that reaches a window is primarily determined by the sky exposure angle (fig. 1). The sky exposure angle required to provide a given level of daylight at the building facade generates the sky exposure plane. A regulating sky exposure angle is often used in urban development rules to determine the street wall height.

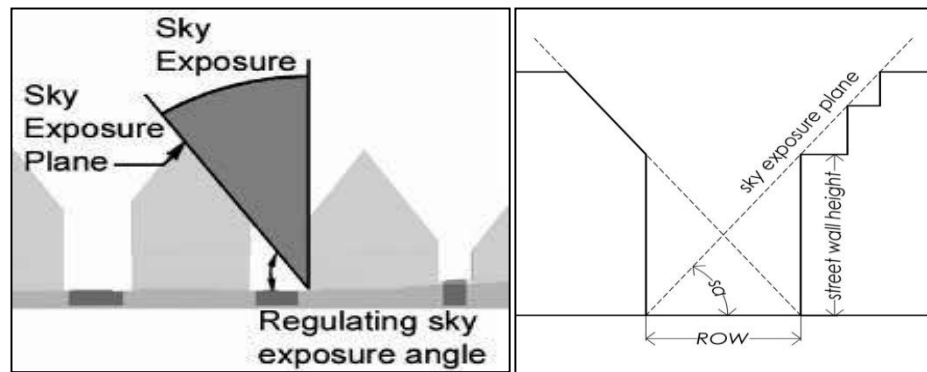

Fig. 1: Regulating sky exposure angle and sky exposure plane Source: Google image

When Daylight Access Rule is applied to an urban pattern of blocks and streets, a development envelope can be generated to control the limit of building boundaries so that lower floors of adjacent buildings can also get sufficient daylight. This Daylight Access Rule can be used to determine a maximum H/W ratio for a given DF goal. When street width is fixed, maximum facade height can be calculated and a Sky Exposure Plane can be defined by drawing a line from the opposite side of the street or ROW at ground level through the top of the facade wall. When applied on all four sides of a block, a hip-roof-shaped pyramid is formed above the façade well-defined rectangular volume and that is called a DAYLIGHT ENVELOPE. Blocks can, therefore, be sized to support the desired building height and DF planning goal. For a 215 lux goal, an average DF of 1.25-2.0% is required in the North latitude class of 26° of Guwahati. The Daylight Access Rule indicates that a 1.25% DF requires a maximum H/W ratio of 1, corresponding to a 55° exposure plane. Other daylight criteria and assumptions for surface and window characteristics would yield variations in the recommended sky exposure plane.

2.2 Framework of daylight control

The framework of daylight control includes various daylight control regulations which are concerned with the exterior daylight access and interior daylight use in a building. According to White (White 1988), Two commonly used basic daylight regulations are: firstly, the urban design regulations, which affect the level of daylight reaching the exterior side of a building and secondly, the energy conservation regulations which concern with the interior lighting levels and integrating day lighting with the artificial electric lighting, affect primarily to the interior part of the envelope. Urban design regulations deal primarily with the daylight access while energy conservation regulations usually address how the daylight is used in the interior.

There are significant differences between explicit and implicit daylight controls. Implicit control affects the amount of daylight enters into space but they omit the critical factors such as climate, orientation and latitude and allow a predictable level of daylight. This type of lighting controls the conventional zoning, setbacks and floor area ratio (FAR) and building code requirements of the minimum window area. According to White (White 1988), explicit controls systematically control the major variables.

Meanwhile, the prescriptive and performance daylight controls distinguish the rules or codes. Mostly performance and prescriptive methods are used for defining explicit controls. Table 2 shows the graphical representation of various methods of daylight control.

Table 2: Framework of Daylight controls

Type of Regulations	Implicit Control	Explicit controls	
		Prescriptive Controls	Performance controls
Urban Design Regulations	Zoning setbacks & FAR	H/W ratio	Daylight indicator
	Open space requirements	Sky exposure plane	
	Solar access	Daylight spacing angle	
Energy conservation regulations	Min. window area	Window / Floor area ratio	Daylight factor requirement
	Shading and glazing requirement		
	Light power limit		

2.3 Review of daylight planning tools

There are various daylight planning tools which are commonly used for site planning and urban design decisions.

2.3.1 Setback and Height/Width ratios in zoning regulations

FAR is the most common parameter which is used as development bye laws in Indian cities to control building bulk to match the development density with infrastructure capacity. But it does not control the placement and orientation of building which directly linked with the daylight access. Zoning regulations commonly address daylight access in two ways - minimum setback of the building from the property line which is a implicit control and the building height to street width (H/W) ratios which is potentially an explicit control regulation. Therefore, setback and Height to width (H/W) ratio is the most commonly used explicit regulation for daylight access in Indian cities.

2.3.2 Daylight spacing angles

Daylight spacing angles is a simple technique, designed to space parallel rows of residential buildings. It assumes overcast sky condition and daylight factors sufficient for residential tasks. the spacing angle is associated with a particular latitude and presented in

chart form. Each latitude is associated with one climatic condition daylight factors are not explicitly stated. The chart should be used with some degree of interpretation if the climate under consideration does not match with the climate given for a site's latitude (Fig.4) . For Guwahati city, the minimum spacing angle is 55° At a latitude of 26.11° North.

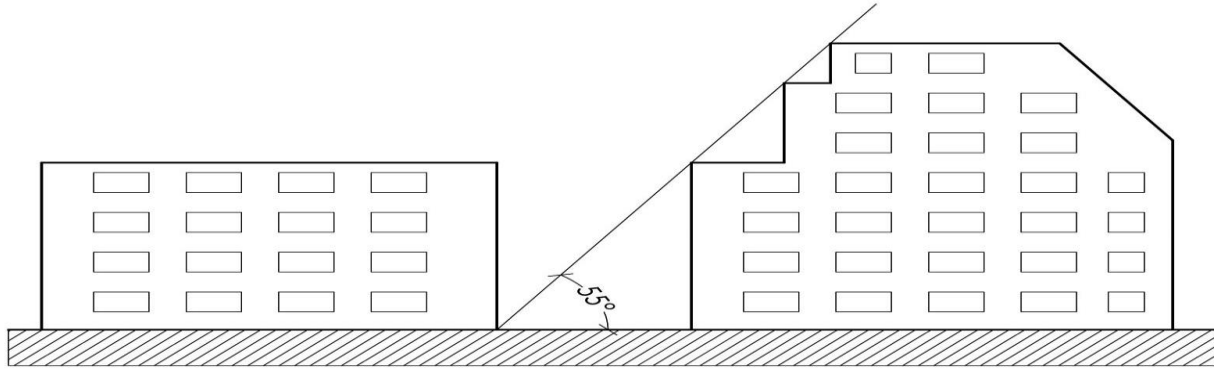

Fig. 2 Spacing angle (degrees) in 26.11° N latitude Of Guwahati

Source: Sun, Wind and Light

2.3.3 Permissible height indicator (PHI) and Sky view factor (SVF)

Permissible daylight indicator (Hopkinson, 1967) is essentially a graphic performance tool that establishes a height-width (H/W) ratio and allows for more variability in design than conventional sky exposure plane. It is a graphic tool used with site plan drawing. Permissible daylight indicator is used to determine obstructions and allowable building height that will protect the access to a portion of skydome from all parts of the building.

Permissible daylight indicators apply to different sky conditions such as uniform, overcast, clear sky. This tool is used for different building types and related to property edge. The indicator establishes a cone of view defined by an angle of the horizontal and vertical angle of acceptance. Concentric rings around the point of view give increasing acceptable height of the building. This tool is used to measure exposure at a height of 2 meters above ground level and with a neutral orientation.

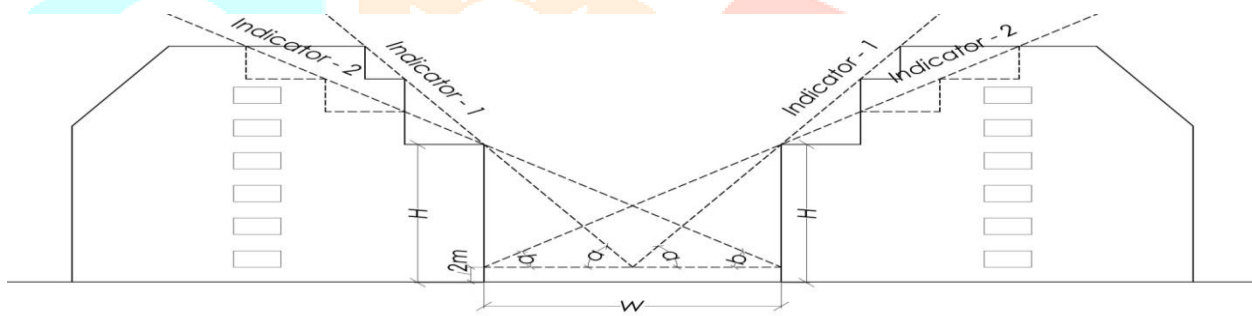

Fig. 3 Permissible height indicator

Sky view factor (SVF) is a measure of the degree of the site sky visibility. It represents a ratio at a point of space between the visible sky and the hemisphere centred over the analysed location (Oke 1981). The SVF is a geometric performance tool within the urban canyon that establishes a relationship with height width (H/W) ratio (Oke 1981; Johnson and Watson 1984) and allows more variety in design than conventional sky exposure plane.

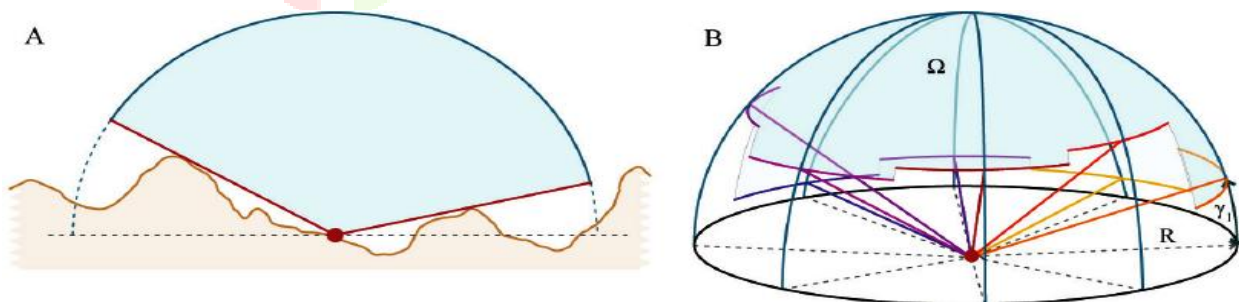

Fig. 4 Sky View Factor (source : Google image)

The sky view factor (SVF) is calculated from the following formula:

$$SVF = \cos(\tan(H/0.5W))$$

Where, H is the street height of the building and W is distance between two rows of buildings in the urban canyon geometry.

2.3.4 Solar envelope

Solar envelope defines maximum developable volume derived from the sun's motion with a particular site that will not shade adjacent building or site during critical times. The size and shape of solar envelope vary with the size of the plot, orientation, latitude, time of the day solar access is desired and amount of allowable shading on adjacent streets and building. It is used as a means of development control, as an extension of zoning regulations and is intended to protect sunlight access.

Longitude , Latitude

Date / , (1900~2099)

Time zone h, DST OFF ON

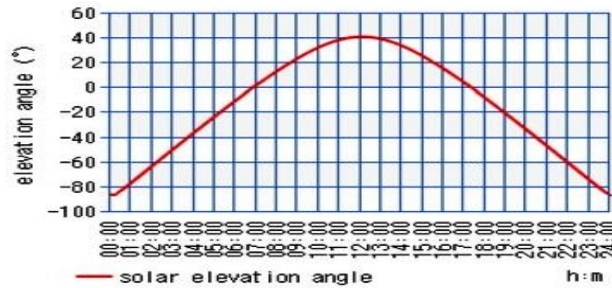

Fig.3 Solar elevation angle of National Games Village, Guwahati at 9.00AM, Dec21, 2019

Sun light can potentially contribute significantly to interior building illumination. The solar envelop is a technique limiting development bulk and limits development to moderate densities, therefore it has the potential to ensure sufficient day light access to building interior. Table.4 shows the solar elevation angle and azimuth angle of National Games Village of Guwahati at 9.00 AM on 21 Dec. 2019.

Table 3: Solar elevation angle and Azimuth angle of Guwahati

Time in hh:mm	Solar Elevation Angle (degrees)	Azimuth Angle (degrees)
09.00 AM	22.71	133.21
10.00 AM	31.54	145.07
11.00 AM	37.78	160.00
12.00 PM	40.43	177.41
01.00 PM	38.94	195.20
02.00 PM	33.63	210.96
03.00 PM	25.45	223.68

Source: Kaisan online calculator

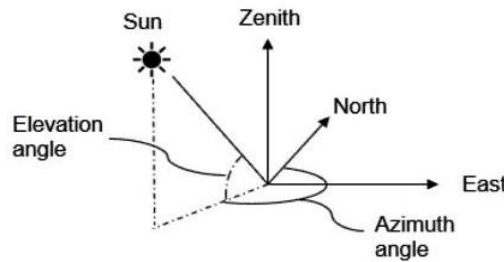

azimuth angle: north=0, east=90, south=180, west=270 degree

Fig.4 Solar elevation angle and Azimuth angle

Source: Kaisan online calculator

2.3.4.1 Construction process of Solar Envelope in Guwahati Latitude of 26.11° N



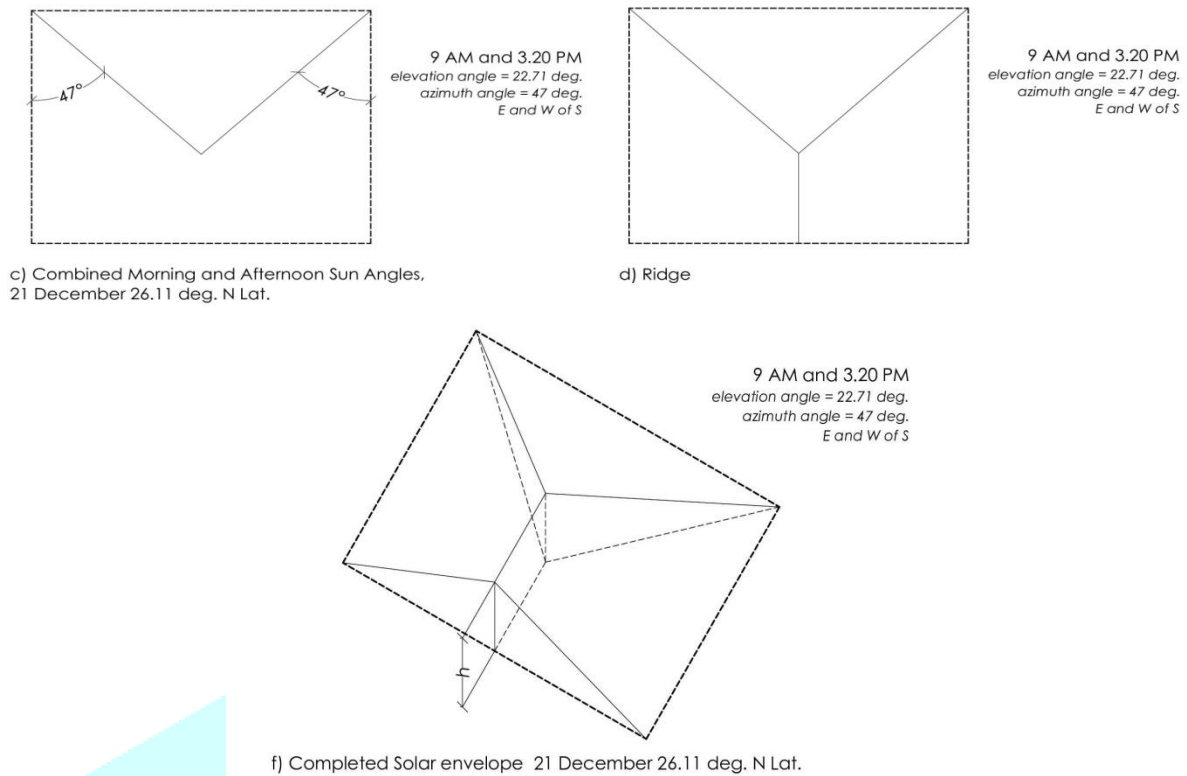

Fig.5 Solar envelope construction process in 26.11° N lat. Of Guwahati

2.4 Comparison of basic characteristics of daylight tools

Basic characteristics of daylight planning tools are compared and results are shown in Table 5. Sunlight and skylight indicate which condition the tool attempts to control. Daylight indicators address both. Latitude indicates whether the tools account for variations for daylight availability by latitude. Sky condition indicates whether a tool distinguishes between overcast sky and clear sky conditions at a given latitude and takes into account the deferring skydome luminance distribution.

Table 4: Comparison of Daylight planning tools characteristic

Daylight planning tools	Characteristics											
	skylight	Sunlight	Latitude	Sky condition(O)	Street wall	Seasonal schedules	Orientation	Reflectivity	Building types R	Quantitative light standard	Format	Intent to protect
Daylight spacing angle	Y		Y	y	Y				y	Res. D.F.	Section/formula	Bldg
PHI and SVF	Y	Y	Y	Y	Y	I	I		Y	% sky factor	Section/formula	Bldg/property
Solar envelop		Y	Y		Y	Y	Y				Envelope/ formula	Bldg/property
Setbacks and H/w ratios	Y				Y				Y		Numeric	Zone Character

Street wall exposure plane indicates a prescriptive requirement for these variables. Seasonal schedules denote the ability of a tool to distinguish between summer and winter sun angles and the seasonal variations of daylight availability. Orientation indicates whether a building or site's azimuthal declination and aspects are addressed. Reflectivity indicates higher exterior building material reflectivity.

Building type indicates the distinguish between daylight requirement for a residential and commercial building. The quantitative light standard indicates the method to measure daylight. Only daylight spacing angle (DSA) and daylight indicator (DI) address explicitly daylight to buildings. DSA provides daylight factor suitable for residences and DI assures a given percentage of the sky viewed inside from a room, generally considered one component of daylight factor.

The comparison of these daylight planning tools gives us a clear picture that no single planning tools address all the important variables that influence daylight access. All tools address prescriptive street wall height for a given street width and suggest an H/W ratio through a prescriptive exposure plane angle. Street wall height continuation is an important urban standard within a neighbourhood.

2.5 Comparison of techniques for Maximum allowable envelope for density implications

Daylight planning techniques address the prescriptive street wall differently for a given street width and suggest a different H/W ratio through respective sky exposure plane angle. Each daylight planning technique suggests different developable volume with the same prescriptive road width. A comparative study is done to understand the significance of the urban density variations by applying these daylight planning tools in an existing residential complex within the Guwahati Metropolitan Area (GMA). The case study area is situated at Borsajai, Guwahati with a latitude of 26.11° north.

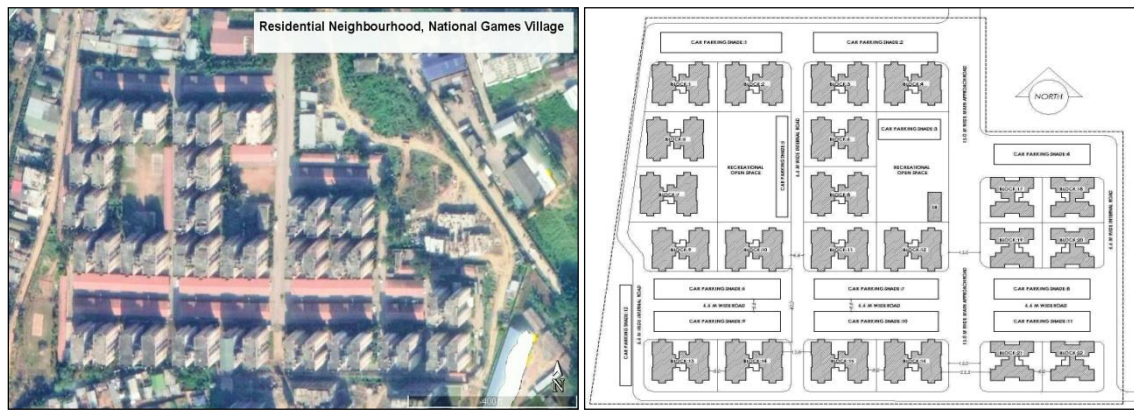

Fig. 6: satellite map of case study area (left) and Model Plan of Residential neighbourhood (right) of National games Village, Borsajai, Guwahati

Four basic daylight planning techniques are compared to understand the significance of the urban density variations by applying these tools to a residential complex of 21 urban blocks of 27.15m x 20.65m at 26.11° North latitude of Guwahati city. The envelopes generated by these techniques are shown in figure 8. Gross volume and gross FAR allowed by the generated envelope is calculated for each tool for an existing building block of 21m in height with a story height of 3m. The angle of the exposure plane is also listed in table 6.

Table 5: The technique used for each tool

Daylight Technique	Variables used	Wall Height (m)	H/W ratio
DSA	1. Daylight spacing angle	15.6m	1.56
	2. Latitude 26.11 deg. N		
PHI and SVF	1. Residential occupancy,	18.6m	1.86
	2. Overcast Sky		
	3. Building to building overlay		
Solar Envelope	1. Latitude 26.11 deg. N	12.6m	1.26
	2. Solar elevation angle and azimuthal angle		
	3. Lower two stories shading allowed		
Setbacks and H/W ratios	1. GMDA setbacks and existing ROW	21.6m	2.16

Table: 6 shows the FAR and Maximum Allowable Volume (MAV) calculations of the case study building for various daylight planning techniques.

Plot area of the case study building = 1138.65 Sqm

Table 6: Calculation of FAR, Maximum Allowable Volume and ground coverage

Daylight Planning Tools	Floor area of the building (Floor height = 3.0m)							Total floor area (Sqm)	Str. Wall Height(m)	MAV (Cum)	Coverage (%)	FAR
	1st	2nd	3rd	4th	5th	6th	7th					
Setback	512.5	512.5	512.5	512.5	512.5	512.5	512.5	3578.5	21.6	11070.0	45%	3.15
DSA	512.5	512.5	512.5	512.5	512.5	212.5	212.5	2787.5	15.6	9270.0	45%	2.62
PHI and SVF	512.5	512.5	512.5	512.5	512.5	512.5	275.5	3350.5	18.6	10359.0	45%	2.94
Solar Enve	512.5	512.5	512.5	512.5	232.5	105.0	-	2387.5	12.6	7470.0	45%	2.10

3. RESULTS AND DISCUSSIONS

All of the daylight planning tools are conceptualised to control sky exposure plane angle by limiting street wall height and spacing between adjacent buildings. In all the cases, Ground coverage kept at 45% as per GMDA regulations. H/W ratio recommendations vary between 1.26 to 2.16. Maximum Allowable Volumes (MAV) allowed among daylight planning tools vary from FAR 2.1 to FAR 3.15. The lowest density was generated by the solar envelope. Table: 7 shows the comparative analysis of the Maximum allowable Volume (MAV) and FAR for various daylight planning tools.

Table 7: Comparative statement of Maximum Allowable volumes in different planning tools

Daylight Planning Tools	H/W ratio	MAV(Cum)	FAR	Exposure Plane angle	Remark
DSA	1.56	9270.00	2.62	55°	Daylight reaches to ground floor
PHI & SVF	1.86	10359.00	2.94	58°	Daylight reaches to First floor
Solar Envelope in 21 Dec.	1.26	7470.00	2.10	22.71°	Daylight reaches to ground floor and solar radiation reaches to 2nd floor
Setbacks and H/W ratios	2.16	11070.00	3.15	90°	No daylight and Solar radiation reaches ground floor and first floor

Actual FAR net shown will be less than the gross because of building floor setbacks as the practical building meet maximum sloping envelopes.

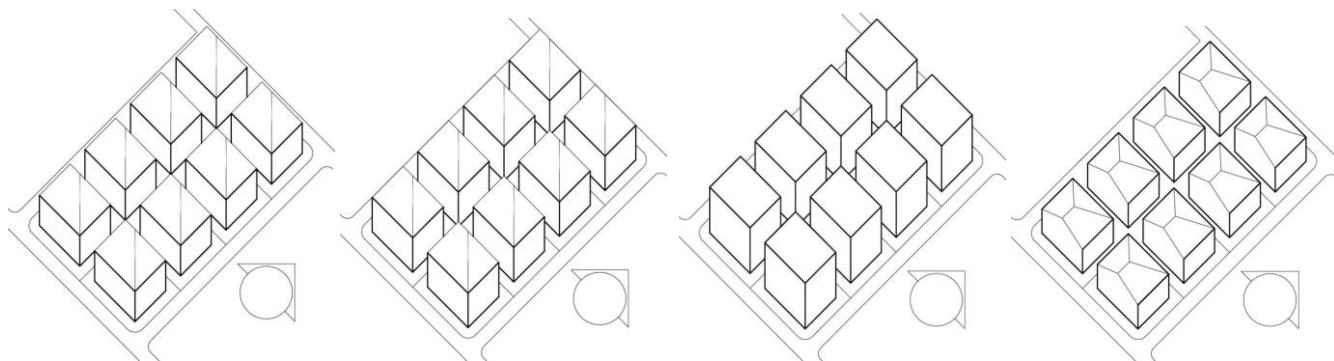

Fig.7 Daylight spacing angle Fig.8 Daylight Indicator Fig.9 Setback and H/W ratios Fig.10 Solar Envelope

3.1 Technical Analysis and Discussions

The graph shown in figure 11 indicates that the mean daylight factor and mean minimum daylight factor is proportionate to building height/ street width (H/W) ratio.

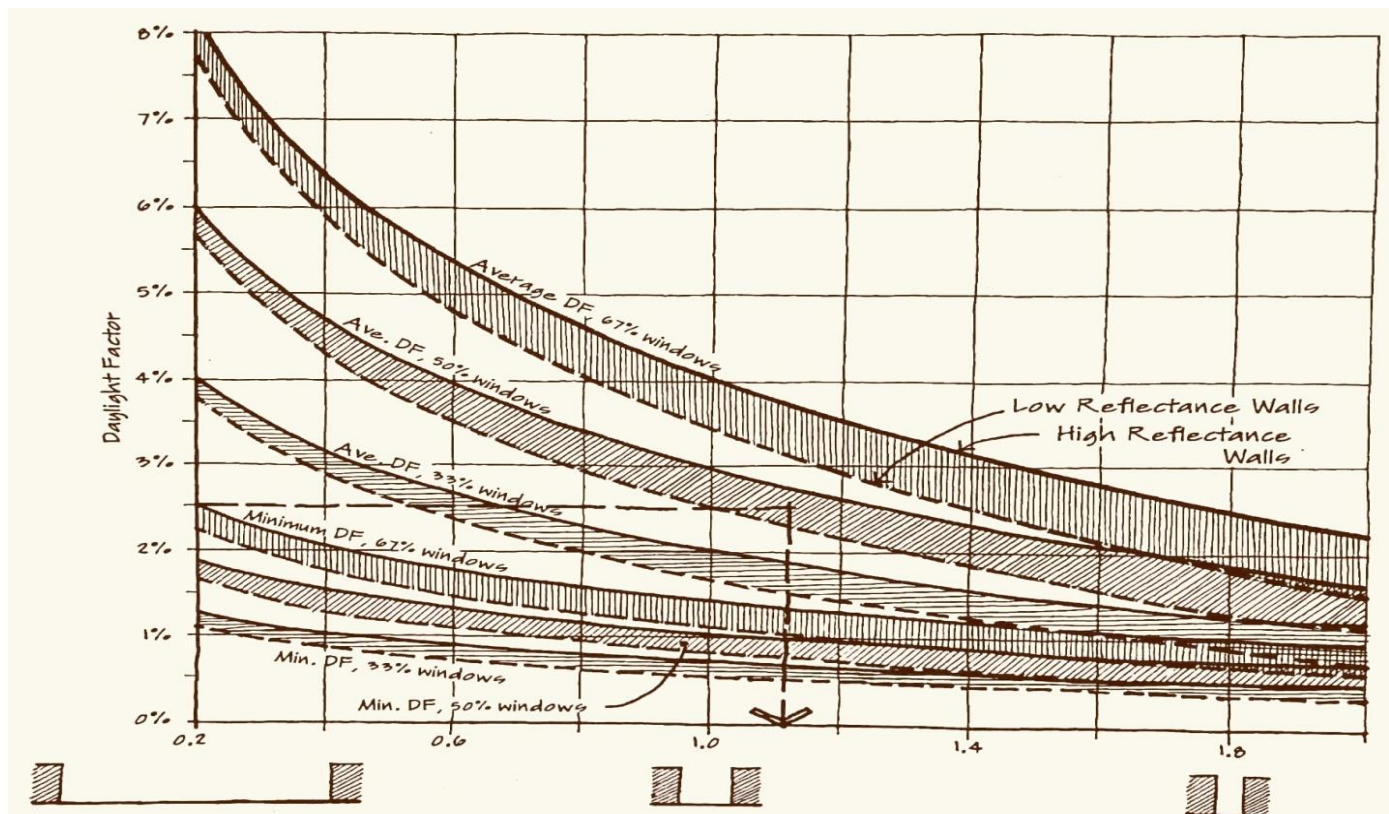

Fig. 11 Daylight Factor as a function of street canyon proportions Source: Sun, Wind and Light

Results shown in the graph are valid in a strictest sense of overcast sky conditions and as a result the variance of daylight distribution in different sky conditions is not a major factor. Two major variables that can alter DF: H/W relationships are:

1. Reflectance of exterior wall
2. Area of windows in the exterior wall of the reference room

Significant effect of urban canyon proportions on daylight levels can easily be seen from this graph. The daylight factor inside the building decreases with the increasing H/W ratios. Increase in window area affects increasing daylight factors. Larger increases occur in lower H/W ratios. The practical upper limit of increasing window area is about two-third of the area of the exterior wall. Increasing wall reflectivity has a greater impact at higher H/W ratios since a larger percentage of interior illumination is derived from reflected light. At low H/W ratios, increasing window area has a much greater impact on raising DF than increasing wall reflectivity.

Using the graph, for an average ambient light level of about 2.5% D.F, an H/W ratio of about 0.8 is required. This suggests for a city concerned with projecting daylight access to the lower floors of the building with a relationship such as:

For an average DF >2%, keep H/W ratios <1

Typical ROW of Guwahati varies from 13.8m -24.0m for residential streets. Collector and arterial streets ROW's are 24.0m to 36.0m.

Using the above relationship to protect daylight access and assuming a consistent street wall height, the limits would apply for following height (story height = 3.0m)

Table 7: Comparison of Allowable volumes in different right of way (ROW)

ROW	Nos of stories	% of windows	reflectance
13.8 m	4 storied	33%	High reflectance wall
24.0 m	6 storied	33%	High reflectance wall
36.0 m	10 storied	33%	High reflectance wall

With the help of H/W ratios establishing a maximum street wall height, a prescriptive daylight access envelope can be determined by sky exposure plane creating a paramedical envelope stepping back from the step wall. This is the technique that will be used to determine approximate bulk limits in planning measures such as FAR and relative patterns of land use for daylight access.

4. CONCLUSION

In this study, an effort has been made to understand the daylight access control through the framework of daylight planning tools. This study compares distinctions between various controls such as urban design regulations and energy conservation controls, the implicit and explicit controls, and between performance and prescriptive controls. Most common daylight access controls have been summarized, compared and analysed for density implications of GMDA regulations. It has been observed that each tool controls sky exposure plane by limiting street wall height or spacing between buildings. For north latitude of 26.11 in Guwahati, H/W ratios vary between 1:1 to 2:1. Maximum allowable daylight envelopes and maximum FAR for various planning tools are worked out. The analysis of the graph shows a simple approximate relationship between street width to building height and the daylight levels found in the adjacent spaces. This rule will allow determining maximum street wall height for a given street width or to determine the side and rear setbacks of building for a fixed building height.

Some general conclusions of this study are as follows:

1. The daylight factor inside the building decreases with increasing H/W ratios.
2. The average DF and minimum DF increases in lower H/W ratios. The practical upper degree of increasing the window is 2/3 area of the exterior wall.
3. Increasing reflectivity of the exterior wall increases the interior DF and has a greater impact on higher H/W ratios.

This study is not only help in framing GMDA building bye-laws incorporating energy-efficient principles in building design but also help to determine urban zoning controls for daylight access and street right of way (ROW) dimensions.

REFERENCES

- [1] Brown, G.Z and Dekay, M., "Sun, Wind and Light, Architectural Design Strategies, 2nd Edition"
- [2] GMDA Building Bye-Laws 2014
- [3] Kaison online Calculator for solar elevation and Azimuth angle calculation
- [4] Knowles, R. 1981 "Sun, Rhythm, Form"
- [5] Model Building Bye laws 2016
- [6] White, R. 1988, "Daylight and Sunlight regulations for cities"
- [7] Edward Ng Department of Architecture, Chinese University of Hong Kong, "A study of the relationship between daylight performance and height difference of buildings in high density cities using computational simulation"
- [8] Tong Lyu, School of Architecture and Urban Planning, Nanjing University, China ; Riccardo Buccolieri, Department of Biological and Environmental Sciences and Technologies, University of Salento, Italy; Zhi Gao, School of Architecture and Urban Planning, Nanjing University, China , "A Numerical Study on the Correlation between Sky View Factor and Summer Microclimate of Local Climate Zones"
- [9] Cristina S. Polo Lópeza, University of Applied Sciences and Arts of Southern Switzerland, Switzerland; Mariaemma Salab, Politecnico di Milano, Milan, Italy; Lavinia Ch. Tagliabuec, c University of Brescia, Brescia; Francesco Frontinia, University of Applied Sciences and Arts of Southern Switzerland, Switzerland; Salim Bouziria, University of Applied Sciences and Arts of Southern Switzerland, Switzerland; "Solar radiation and day lighting assessment using the Sky-View Factor (SVF) analysis as method to evaluate urban planning densification policies impacts",
- [10] M. Dirksena, KNMI, Utrechtseweg 297, De Bilt, The Netherlands; R.J. Rondab, Wageningen University & Research, Droevendaalsesteeg 4, Wageningen, The Netherlands; N.E. Theeuwesc, University of Reading, RG6 6AH, United Kingdom; G.A. Paganian, KNMI, Utrechtseweg 297, De Bilt, The Netherlands, "Sky view factor calculations and its application in urban heat island studies"
- [11] Jérémy Bernard, CNRS, UMR 6285 Vannes, France; Erwan Bocher, CNRS, UMR 6285 Vannes, France; Gwendall Petit and Sylvain Palominos, Université de Bretagne Sud, UMR 6285 Vannes, France; "Sky View Factor Calculation in Urban Context: Computational Performance and Accuracy Analysis of Two Open and Free GIS Tools"