



# INTERNATIONAL JOURNAL OF CREATIVE RESEARCH THOUGHTS (IJCRT)

An International Open Access, Peer-reviewed, Refereed Journal

## WIRELES HEALTH MONITORING SYSTEM

<sup>1</sup>Nikhil Gupta, <sup>2</sup>Mohd. Asif, <sup>3</sup>Sidra Anwar, <sup>4</sup>Simmi Saxena, <sup>5</sup>Smita Upadhyay

<sup>1,2,3,4,5</sup>UG Scholar

<sup>1</sup>Electronics and Communication Engineering Department,

<sup>1</sup>Shri Ram Murti Smarak College of Engineering and Technology, Bareilly, India

**Abstract:** Wireless health monitoring system is a concept to realize the advancements in health monitoring systems of human beings as people now a day are suffering from a lot of diseases. In this monitoring system, people can get their pulse rate, body temperature & glucose level being checked by just placing their finger/ hand as per the requirement by respective sensors.

In our project we have designed an electronic system to measure the basic yet important body parameters which get affected / changed while suffering from any disease. The respective sensors have been putted in the system for the monitoring of the same. Here the non- invasive technique is being used in the device, which offers simple yet effective means of measurement. Mainly non – invasive technology is used to free the patient from pain of finger pricking, each time the glucose measurement is being made. Glucose content in the blood is measured through communication between optical source (LED) and optical detector (Photo detector) card provided in the device .The total cost of the system is not much and is affordable to all class of people. This will give advantage to avoid the time delay in diagnosis of the minor and major health problems.

Nowadays people are looking forward for a system that can satisfy their needs more comprehensively. Most of the existing systems are looking for any device or subsystem that enhances the experience of the patient. In traditional systems, the measurement, being made, is poorer. This project aims to innovate the techniques & methodologies so as to improve the diagnosis experience of people. Today's era is said to be the world of technology. So many efforts have been taken to adopt information and communication to enhance the experience. This paper highlights some of the limitations of the conventional systems based on invasive measurement techniques & elucidates the advantages of using the non-invasive techniques.

**Keywords:** GSM (global system for mobile communication), IR (infra-red), PIC (peripheral interface controller)

### I. Introduction

Now a day's diseases are highly prevalent, with an estimated 466 million people suffering from it worldwide. Temperature & pulse rate are the two major concerns relating to health of every person. These two parameters got affected/changed, in almost every suffering and in diabetics; defects in insulin secretion or insulin action prevent cells from taking up glucose leading to hyperglycemia, i.e. higher than normal levels of glucose in blood.

Persistent hyperglycemia leads to a host of micro- and macro- vascular complications such as impaired vision and renal function. Control of blood glucose levels in the normal physiological range with multiple glucose measurements and intensive insulin therapy delays, onset and progression of complications.

The advancement in technology has greatly influenced the lives of people. The adoption of digital technology has led to automation in almost every industry. The daily innovations in STEM (Science, technology, engineering, mathematics) have increased advancements in disease diagnosis. This project aims to build a Non – invasive technique of glucose measurement so as to improve the diagnosis experience of human beings. Here we discuss the design & implementation of Non-invasive glucose monitoring subsystem along with the temperature and pulse rate monitoring subsystems they all when combined form a health monitoring system to meet the requirements of a patient & for a healthy human being too. The device owner can manage the modifications easily. Proposed system provides fast access to any and all types of media, with no text bound interface getting in the way. Faster input can mean better service

## II. Literature Review

The journey for getting up to the peak of joy and facilities that we are presently experiencing started with initial footstep of a wireless technology. The introduction of basic proposed systems and consequent developments are been mentioned here.

The application of wireless health monitoring system presented in-depth on the technical operation of healthcare kit based Wireless System (WOS) including systems architecture, function, limitations and recommendations.

By introducing the integration of GSM technology as the communication medium and Peripheral Interface Controller (PIC) as the hardware which implements faster system.

Due to the limitations in the existing technologies we proposed the advanced system, which focuses on low cost healthcare system development to enhance the health issues diagnosis experience. A control system for the proposed system is used in prevention and cure of diseases. System having minimal centralized control is developed.

The integration of GSM technology in health monitoring system, this system was a basic dynamic database utility system which fetches all information from a centralized transceiver.

## III. Problem Statement

Current state-of-the-art systems are fitted with glucose monitors which require people to prick their fingers and test drops of blood using electrochemical testing strips at regular intervals throughout the day. The discomfort and high cost per measurement associated with the procedure leads to irregular testing, resulting in poor treatment outcomes. Non-invasive glucose monitoring offers painless and sample free measurements in a continuous manner, encouraging regular monitoring and control

Along the non-invasive glucose measurement problem there are further more problems which are specially bound to the rural areas where people are not getting proper facilities to prevent them from the health issues. Also there is no proper availability of the doctor nearby. They need to run to big cities in order to have better treatment which costs them so huge have selected photo acoustic (PA) effect for the same due to its ability to measure small absorption coefficients produced by glucose without affecting tissue. It also requires little or no sample preparation before measurement, and is not affected by optical scattering by tissues.

## IV. Proposed System

There is great advancement in technology due to its features like low cost and ease of use. This technology allows us a faster and more convenient access to the world. The Healthcare monitoring system is a revolutionary concept & is sure to take people by surprise. This system is convenient, effective and easy thereby improving the performance of diseases' diagnosis. It will also provide quality of service and customer satisfaction. It will undoubtedly change the way people react towards taking care. It would lead to increased revenues; give the customer a better insight into the kind of health issue they are suffering from

The electronic health care system helps the people to measure their body temperature; glucose level & pulse are on a very regular basis through the sensors. The nearby doctor/hospital gets alerted through a message announcement as well as he get to know that which kind of health issue, the patient is suffering with. RF communication is used for this purpose. This is very much helpful in every area of society where the outreach time is much greater.

## V. Block Diagram Representation

The whole system architecture can be seen by this basic diagram below. The system starts from the sensor interfaces. The system is designed to monitor the health status. When any of the parameters reaches above the threshold value, a notification in the form of message is sent so as to inform that person is suffering from any disease which can be diagnosed later. The sensors are initialized on switching on the supply. The Buzzer beeps a sound which is an indication that any of the parameter value has reached above the threshold and there is a need to take care of that person.

The LCD display displays the real time parameter values which are the values of temperature, pulse rate and glucose level in the blood as these all are the main parameters to be known in order to examine the health status of any person. The MCU sends a control signal to the GSM module & buzzer to share indication in this respective ways when any parameter with above threshold value is found.

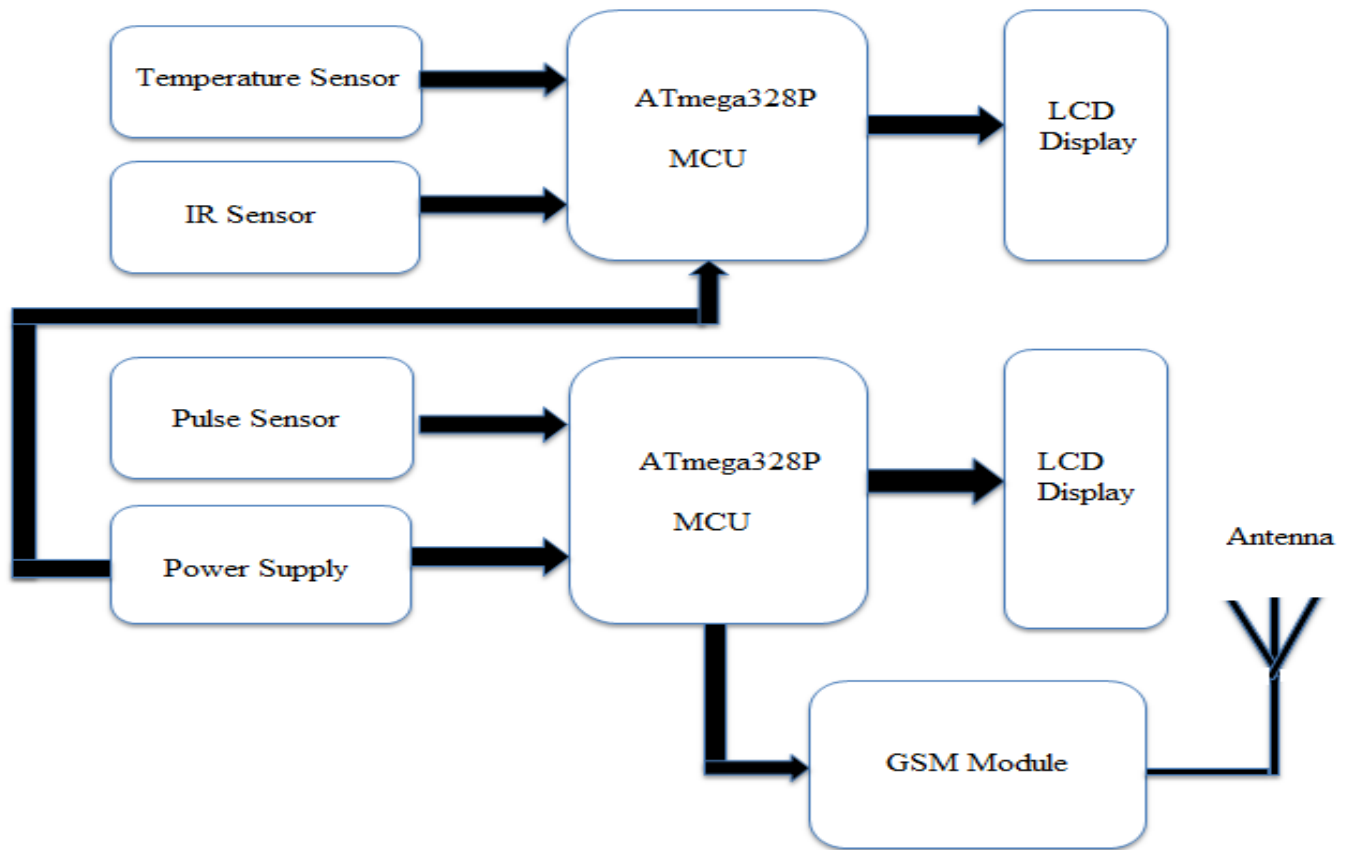

Fig. 5.1 Block Diagram of Proposed System

## VI. Hardware Requirements

### 6.1 ATmega328P MICROCONTROLLER

The ATmega AVR family (later microchip technology acquired Atmel in 2016), has a modified Harvard architecture 8-bit RISC processor. The Atmel 8-bit ATmega328P is a single-chip microcontroller created by Atmel in RISC-based microcontroller combines 32 Kb ISP flash memory with read-while-write capabilities, 1 Kb EPROM, 2 Kb SRAM, 23 GPIO lines, 32 general purpose working registers, flexible timers/counters with compare modes, internal and external interrupts, serial programmable USART, a byte-oriented 2-wire serial interface, SPI serial port, 6-channel 10-bit A/D converter, programmable watchdog timer with internal oscillator and five software selectable power saving modes. The device operates between 1.8 -5.5 volts. The device achieves throughput approaching 1 MIPS per MHz



Fig.6.1 ATmega328P

### 6.1.1 Pin Configuration

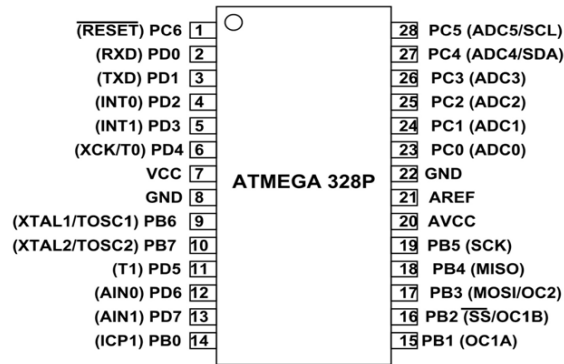

Fig. 6.1.1 ATmega328 Pin configuration

A common alternative to the ATmega328 is the "Pico Power" ATmega328P.

- ATmega328
- ATmega328P and ATmega328P-AUTOMOTIVE
- ATmega328PB and ATmega328PB-AUTOMOTIVE (superset of ATmega328P)
- It has more UART, I2C and SPI Interfaces than ATmega328P

### 6.2 GSM Module

GSM/GPRS module is used to establish communication between a computer and a GSM-GPRS system. Global System for Mobile communication (GSM) is an architecture used for mobile communication in most of the countries. Global Packet Radio Service (GPRS) is an extension of GSM that enables higher data transmission rate. GSM/GPRS module consists of a GSM/GPRS modem assembled together with power supply circuit and communication interfaces (like RS-232, USB, etc.) for computer. The MODEM is the soul of such modules.

GSM/GPRS MODEM is a class of wireless MODEM devices that are designed for communication of a computer with the GSM and GPRS network. It requires a **SIM (Subscriber Identity Module)** card just like mobile phones to activate communication with the network. Also they have **IMEI (International Mobile Equipment Identity)** number similar to mobile phones for their identification. A GSM/GPRS MODEM can perform the following operations:

- Receive, send or delete SMS messages in a SIM.
- Read, add, search phonebook entries of the SIM.
- Make, Receive, or reject a voice call.

A GSM/GPRS module assembles a GSM/GPRS modem with standard communication interfaces like RS-232 (Serial Port), USB etc., so that it can be easily interfaced with a computer or a microprocessor / microcontroller based system. The power supply circuit is also built in the module that can be activated by using a suitable adaptor

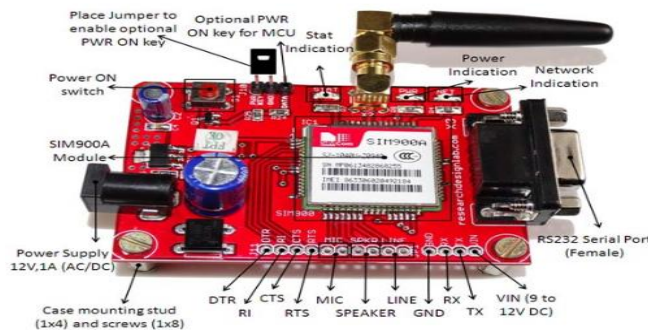

Fig. 6.2 GSM SIM900 A

### 6.3 Pulse Sensor

Pulse Sensor is a well-designed plug-and-play heart-rate sensor for Arduino. It can be used by students, artists, athletes, makers, and game & mobile developers who want to easily incorporate live heart rate data into their projects. The sensor clips onto a fingertip or earlobe and plugs right into Arduino with some jumper cables. It also includes an open-source monitoring app that graphs your pulse in real time

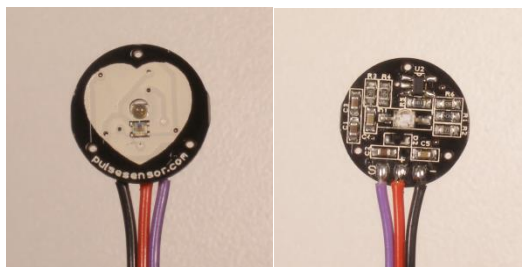

Fig. 6.3 Pulse Sensor

The front of the sensor is the pretty side with the Heart logo. This is the side that makes contact with the skin. On the front you see a small round hole, which is where the LED shines through from the back, and there is also a little square just under the LED. The square is an ambient light sensor, exactly like the one used in cellphones, tablets, and laptops, to adjust the screen brightness in different light conditions.

#### 6.4 Temperature Sensor (LM 35)

In general, a temperature sensor is a device which is designed specifically to measure the hotness or coldness of an object. LM35 is a precision IC temperature sensor with its output proportional to the temperature (in °C). With LM35, the temperature can be measured more accurately than with a thermistor. It also possess low self-heating and does not cause more than 0.1 °C temperature rise in still air. The operating temperature range is from -66°C to 160°C. The LM35's low output impedance, linear output, and precise inherent calibration make interfacing to readout or control circuitry especially easy. It has find its applications on power supplies, battery management, appliances, etc.

The LM35 does not require any external calibration or trimming and maintains an accuracy of  $\pm 0.4^{\circ}\text{C}$  at room temperature and  $\pm 0.8^{\circ}\text{C}$  over a range of  $0^{\circ}\text{C}$  to  $+100^{\circ}\text{C}$ . Another important characteristic of the LM35 is that it draws only 60 micro amps from its supply and possesses a low self-heating capability. LM35 comes in many different packages such as TO-92 plastic transistor-like package, TO-46 metal can transistor-like package, and 8-lead surface mount SO-8 small outline package.

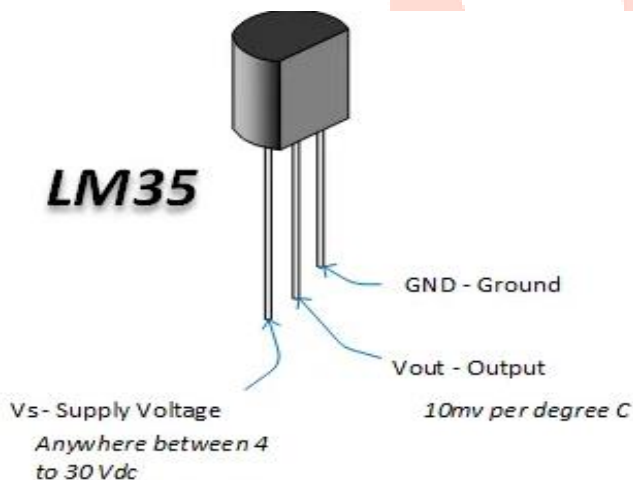

Fig. 6.4 LM 35 Temperature sensor

#### 6.5 IR Sensor

An infrared sensor is an electronic device that emits in order to sense some aspects of the surroundings. An IR sensor can measure the heat of an object as well as detects the motion. These types of sensors measure only infrared radiation, rather than emitting it, called as passive IR sensor. Usually in the infrared spectrum, all the objects radiate some form of thermal radiations. These types of radiations are invisible to our eyes that can be detected by an infrared sensor. The emitter is simply an IR LED (Light Emitting Diode) and the detector is simply an IR photodiode which is sensitive to IR light of the same wavelength as that emitted by the IR LED. When IR light falls on the photodiode, the resistances and these output voltages, change in proportion to the magnitude of the IR light received.



Fig. 6.5 IR SENSOR

## 6.6 LCD Display

LCD (Liquid Crystal Display) screen is an electronic display module and find a wide range of applications. A 16x2 LCD display is very basic module and is very commonly used in various devices and circuits. These modules are preferred over seven segments and other multi segment LEDs. The reasons being: LCDs are economical; easily programmable; have no limitation of displaying special & even custom characters (unlike in seven segments), animations and so on.

A 16x2 LCD means it can display 16 characters per line and there are 2 such lines. In this LCD each character is displayed in 6x7 pixel matrix. This LCD has two registers, namely, Command and Data.

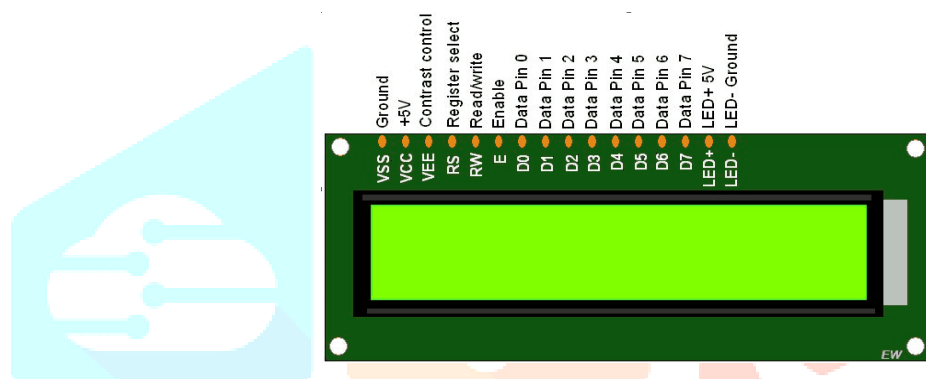

Fig. 6.6 LCD Display

## 6.7 Buzzer

The piezo buzzer produces sound based on reverse of the piezoelectric effect. The generation of pressure variation or strain by the application of electric potential across a piezoelectric material is the underlying principle. These buzzers can be used alert a user of an event corresponding to switching action, counter signal or sensor input. They are also used in alarm circuits.

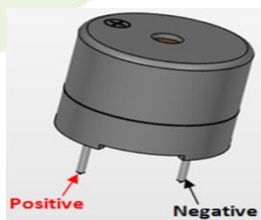

Fig. 6.7 Buzzer

## VII. Software Requirements

### 7.1 Arduino IDE

The Arduino Integrated Development Environment - or Arduino Software (IDE) - contains a text editor for writing code, a message area, a text console, a toolbar with buttons for common functions and a series of menus.

### 7.2 Embedded C

Programming requires nonstandard extensions to the C language in order to support features such as fixed-point arithmetic, multiple distinct memory banks, and basic I/O operations.



## X. Applications & Future Scope

Integrating features of all the hardware components used have been developed in it. Presence of every module has been reasoned out and placed carefully, thus contributing to the best working of the unit. Secondly, using highly advanced IC's/sensors with the help of growing technology, the project has been successfully implemented. Wireless healthcare system is developed in order to provide easy interaction between customers through wireless technology. The project has been successfully designed and tested. Similarly, the system can also be implemented with Graphical LCD for displaying pulse rate, glucose level etc. The system is not more bulky and delicate to handle because each system is going to consist of such modules.

More features could be added like booking an appointment with the doctor on having any moderate issue so as to prevent the problem to become major. There can be a provision that accepts feedback from the people and a registration form so that next time the people can discuss their previous issues as well

The system allows people to diagnose, prevent & cure order food by touching on the digital module surface which is locally connected to the nearby clinic/hospital via GSM module. This implementation were developed to enhance quality of services as well as to enhance customers' experience. The proposed system intensely enhances the speed and reliability for fulfillment. Taking the information through digital system avoid wastage of paper and also reduces the need of printing hard copy. Any person going into hospital does not have to wait for hours, standing in the Queue.

By making selection of microcontroller with large memory size depending upon the family and ROM size of the processor there is a great scope of advancement in this project. We can add graphic images by using SD card and a display with higher dimensions. With the help of technologies like Artificial intelligence (AI) & Internet of Things (IoT), it can be enhanced more.

## XI. References

1. Gibson HM. Managing your wireless spectrum... Making wireless technology work in your hospital. *Biomed Instrum Technol.* 2006 Suppl: 30–36.]
2. Getting the message: results of our survey on cell phone/smartphone policies. *Health Devices.* 2013; 42(4):126–132.
3. Kapa S, Pierce T, Hayes DL, Holmes DR Jr, Asirvatham SJ. Electromagnetic interference of magnetic field based auto identification technologies in healthcare settings. *Int J Med Inform.* 2011 Apr; 80(4):239–250.
4. Judgment call. *Health Devices.* 2012; 41(10):314–329. [PubMed]
5. Methodology checklist 1: systematic reviews and meta-analyses [Internet]. Edinburgh: Scottish Intercollegiate Guidelines Network (SIGN). 2004 Mar [cited 2014 Jan 17]; Available from: <http://www.sign.ac.uk/pdf/sign50annexc.pdf>.
6. Methodology checklist 3: cohort studies [Internet]. In: SIGN 50: a guideline developer's handbook. Edinburgh: SIGN. 2013 [cited 2014 Jan 17]; Available from: <http://www.sign.ac.uk/guidelines/fulltext/50/checklist3.html>.
7. Carranza N, Febles V, Hernandez JA, Bardasano JL, Monteagudo JL, Fernandez de Aldecoa JC, et al. Patient safety and electromagnetic protection: a review. *Health Phys.* 2011 May; 100(5):530–541. [PubMed]
8. Calcagnini G, Mattei E, Censi F, Triventi M, Lo SR, Marchetta E, et al. Electromagnetic compatibility of WLAN adapters with life-supporting medical devices. *Health Phys.* 2011 May; 100(5):497–501. [PubMed]
9. Baranchuk A, Kang J, Shaw C, Campbell D, Ribas S, Hopman WM, et al. Electromagnetic interference of communication devices on ECG machines. *Clin Cardiol.* 2009 Oct; 32(10):588–592. [PMC free article] [PubMed]