

# IOT BASED CIVIL STRUCTURAL HEALTH MONITORING SYSTEM

Tholeti Satya Kiran, Shaik Anwar

M.Tech Student, Assistant Professor

Electronics and Communication Engineering,

Aditya College of Engineering and Technology, Surampalem, India

**Abstract:** The early stage detection of damage and prediction of an upcoming accident in civil structure require continuous structural health monitoring for the large area. The position of sensors and monitoring system also plays an important role in structural monitoring which increases demand for the reliable civil structural monitoring system. On the other hand, determining the dynamic behavior of civil structure require the dense development of sensor. The wired civil structure monitoring system is highly expansive and always needs large installation space to deploy. This project describes wireless sensor network which consumes low power and less space. The wireless sensor network is developed to detect physical parameters of civil structures continuously and send the sensor information to internet cloud server via TCP/IP protocol. The user can access graphical view of various sensors from the cloud server. The cloud server utilizes MATLAB program to give the graphical representation of WSN data. The WSN consists of a sensor to continuously sense various physical parameters of a Civil structure such as temperature, humidity, light, and vibration. WSN user processor interface system with Raspberry pi is in low cost and consumes a small amount of power. The sensor data received will be processed by Raspberry pi using Python programming and sends sensor information to cloud server via internet. On cloud server, a user with server account can access real-time WSN data and view graphically using MATLAB. In this project, an email alert is also developed such that when WSN detect critical values of sensor data and predict upcoming accident in civil structure, it will be notified to the user. The user can also access WSN for an announcement when damage and upcoming accidents are predicted.

**IndexTerms – Raspberry Pi, MATLAB, TCP/IP protocol, WSN, Dynamic.**

## I. INTRODUCTION

Large civil structures such as buildings and bridges form the backbone of our society and are critical to its daily operation. Inspectors typically assess them manually, but a networked computer system that could automatically assess structural integrity and pinpoint the existence and location of any damage could measurably lengthen a structure's lifetime, reduce its operational cost, and improve overall public safety. Structural Health Monitoring (SHM) strategies measure structural response and aim to effectively detect, locate, and assess damage produced by severe loading events and by progressive environmental deterioration.

A wireless sensor network-based data acquisition system, delivers time synchronized structural-response data reliably from several locations over multiple hops to a base station. It supports flexible self-organizing sensor-network deployments of up to several tens of unmetered wireless nodes and avoids the high cabling, installation, and maintenance costs incurred by traditional wired data-acquisition systems. SHM provides a programmable sensor actuator network system that SHM engineers can use to implement algorithms in a higher-level language such as Mat lab or C. It uses a two-tier hierarchy with resource-constrained sensor nodes in the lower tier and more endowed gateway nodes in the upper tier; theoretically, it can scale to hundreds of nodes.

Structural health monitoring calls for sensors that are low-cost, low-profile, and power-constraint. It also requires the sensors to form a network to accurately monitor the low-frequency response that often occurs in many civil structures such as long-span bridges. To monitor a structure (e.g. bridge, building), we measure behavior (e.g. acceleration, vibration, displacement) of structure, and analyze health of the structure based on measured data. However, the existing sensors are either not practice wireless implementation, does not have enough accuracy, or are not cost-effective.

## II. LITERATURE SURVEY

The main aim behind the system is as per the proposed system of CSUXu.et.al [1], it is unable to provide the Health monitoring of civil structures for long distance because of ZigBee technology. As per the proposed system of G.Feltrin H. [2] it is also unable to provide the Health monitoring of civil structures when the host is at remote place. As per the proposed system of J.Salmenen, [3] it is limited up to several meters. The system requires more effective device in this case and the data rates are also very low. These are the main drawbacks of these existing systems. So we need better system to provide the civil structure health monitoring information to the remote unit. The proposed system fulfills these requirements. Only within the past century have scientists used electronic devices to verify the behavior of materials used to construct our society's infrastructure. As electronics technology has evolved, it has become more commonly available, and useful, to structural engineers in both the research and professional arenas. Today, it would be almost impossible to find a consultant who does not use computers as a design aide. Increasingly, monitoring the health of structures will not be solely a function of an annual physical, or visual, inspection by structural engineers. Engineers now, and in the future, will need to use technology in the field to help them verify the behavior of that which they have learned to analyze and design. As more structures are instrumented, we will learn more about their behavior and this can lead to more economical ways to build and maintain them.

As an outcome of the combination of computer technology, communication technology and sensor network technology, it is regarded as the first of 21st century top 10 new technologies that changed the world. With strong data capture and process abilities, it has very expansive application foreground in the fields of military, environment monitoring, disaster prevention and biomedicine, especially in some special fields such as environment monitoring and disaster rescue with nobody on duty, it has advantages that traditional technologies could never compare.

### III. BLOCK DIAGRAM

The System architecture of Civil Structural Health Monitoring System is shown in figure 1. Raspberry Pi, Power supply forms the entire security system to be installed at the required place. An efficient and accurate embedded access control system to be installed at the required place .In these sensors are to be connected with GPIO pins of Raspberry pi, in our project used sensors are digital in nature. So, there is no external ADC converter is required .These sensors directly send the digital information to the raspberry pi and it can process the information and it can be sent to the web page via Ethernet. A web page is an open platform for IOT applications. These can be used to access and store the data and these can be visualized by the Graphical user interface (GUI) by the laptop, pc, smart mobile and give email alert when any parameters cross the threshold values. And it can be helpful to predict the future hazards.

Civil structural health monitoring consists of two blocks...They are

**Part1.** Civil structural monitoring system is a block, which is established in our building where monitoring system is implemented.

**Part2.** Remote control unit is a frame work implemented by the user where we can display the graph and gives alert to the people.

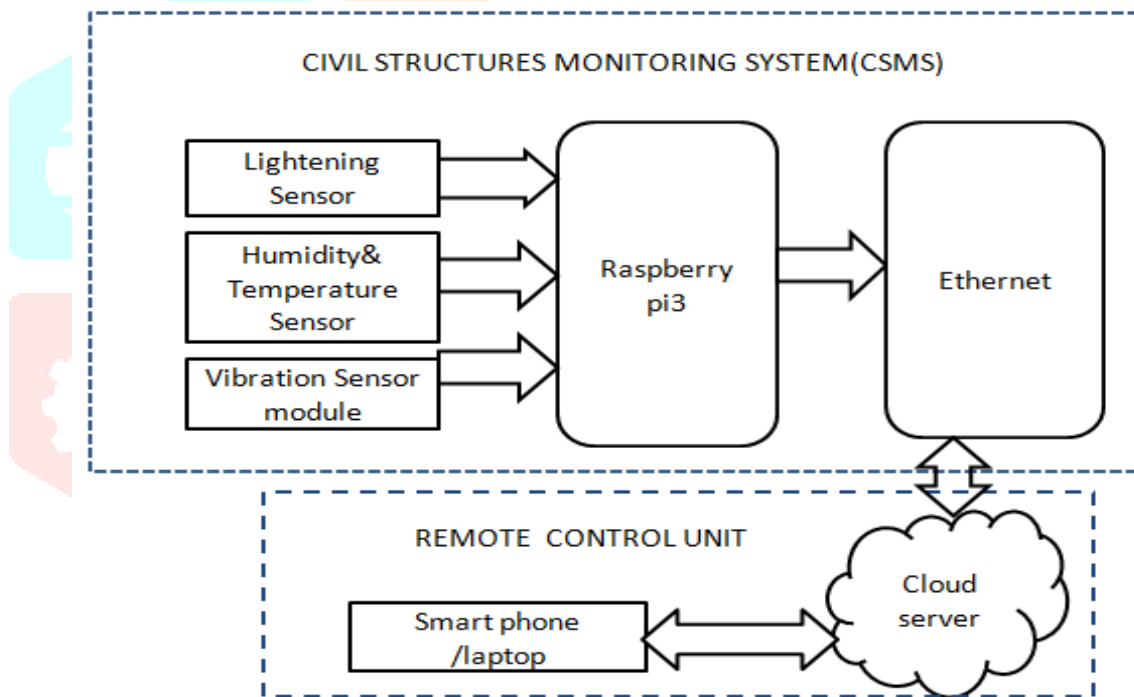

Fig.1 Block diagram

### IV. SYSTEM ARCHITECTURE

IOT Based Civil structural Health monitoring system which consists of two components, Civil structural monitoring System (CSMS) is part of the Civil structure where monitoring system implemented and Remote Control Unit (RCU) is a framework implemented on Users Personal computer or laptop or smart phone.

#### CIVIL STRUCTURAL MONITORING SYSTEM (CSMS)

CSMS is efficient, low power consumption, low cost WSN system for civil structural health monitoring and allows the user to remote monitoring and controlling. CSMS have a Raspberry Pi setup with Raspbian jessi operating system installed on SD card. Our sensors are interfaced with Raspberry pi to detect the temperature, humidity, vibration and light values respectively. These graphs with respect to time and date are saved to ThingSpeak webpage. Generally, our data is saved in the form of entities via TCP/IP protocol.

This block contains five fields .Those are

- **Light Sensor (LDR):**

An LDR is a component that has variable resistance changes with light intensity that falls upon it. These allow them to use in light sensing circuits.

- **Temperature & Humidity Sensor(DHT11)**

DHT11 digital temperature and humidity sensor is a composite Sensor contain a calibrated digital signal output of the temperature and humidity. The DHT11 is a 4-pin (one pin is unused) temperature and humidity sensor capable of measuring 20% - 90% relative humidity and 0 to 50 °C .Communicates using its own proprietary One Wire protocol.

- **Vibration Sensor (SW420)**

The Vibration module based on the vibration sensor SW-420 and Comparator LM393 to detect if there is any vibration that beyond the threshold. The threshold can be adjusted by the on-board potentiometer.

- **Raspberry pi3**

The Raspberry Pi is a single computer board — developed to encourage and aid the teaching of programming and computing. It is also a fantastic starting point for the development of the Internet of Things (IOT) projects.

Pi is the perfect experimental tool, whether you want to use it as a desktop computer, media center, server or monitoring/security device within your home. It has no limits. Linux-based operating systems run on the Pi with plenty of access to free software and download.

The new Pi 3 brings more processing power and on-board connectivity, saving you time with the development of your application.

- **Ethernet:**

Ethernet is a network protocol that controls how data is transmitted over a LAN. Technically it is referred to as the IEEE 802.3 protocol. The protocol has evolved and improved over time and can now deliver at the speed of a gigabit per second.

An Ethernet cable is the most common type of network cable used on a wired network whether at home or in any other business establishment. This cable connects wired devices together to the local network for file sharing and Internet access.

## V. OPERATING PRINCIPLES OF IOT

For the purpose of connecting an object to the IOT, we focus on the Thing speak API. The interface provides simple communication capabilities to objects within the IOT environment. Moreover, Things speak allows you to build applications around data collected by sensors. It offers near real-time data collection, data processing, and also simple visualizations for its users. Data is stored in so-called channels, which provides the user with a list of features. Each channel allows you to store up to 8 fields of data, using maximum of 255 alphanumeric characters each.

There are also 4 dedicated fields for positional data, consisting of Description, Latitude, Longitude, and Elevation. All incoming data is time and date stamped and receives a sequential ID. Once a channel has been created, data can be published by accessing the Thing Speak API with a 'write key', a randomly created unique alphanumeric string for authentication. Consequently, a 'read key' is used to access channel data in case it is set to keep its data private (the default setting). Channels can also be made public in which case no read key is required.

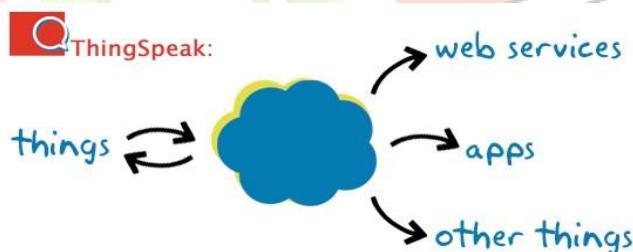

Fig.2 IOT 'cloud' interface

A deeper level of what occurs, especially on the server side. When a device sends data through a HTTP request (communication), it is processed by the IOT service (in this case Thing speak), which communicates with a virtual server. Both the server and the IOT service communicate directly with the application. Finally, at all levels of communication from the device to the application there is both requirements regarding security and management of the data transfer.

## RASPBERRY PI OS

The Raspberry Pi primarily uses Linux kernel-based operating systems. The ARM11 is based on version 6 of the ARM which is no longer supported by several popular versions of Linux, including Ubuntu. The install manager for Raspberry Pi is NOOBS. The OSs included with NOOBS is:

- Archlinux ARM
- OpenELEC
- Pidora (Fedora Remix)

- Raspbmc and the XBMC open source digital media center
- RISC OS – The operating system of the first ARM-based computer

### VI. RESULT ANALYSIS

This chapter discusses the results produced by the system of IOT based civil structure health monitoring system and alerting through Raspberry Pi. In such ways, Observations were made here by taking various constraints into account.

The experimental setup shown in Figure 5 is monitoring the civil structures with wireless sensor network. The CSMS sends the Email alert indicating the update status to the authorized users and the user then sent the command using SSH Client over the Internet to ECU for controlling action. Based on command ECU run the Python script and activate respective devices.

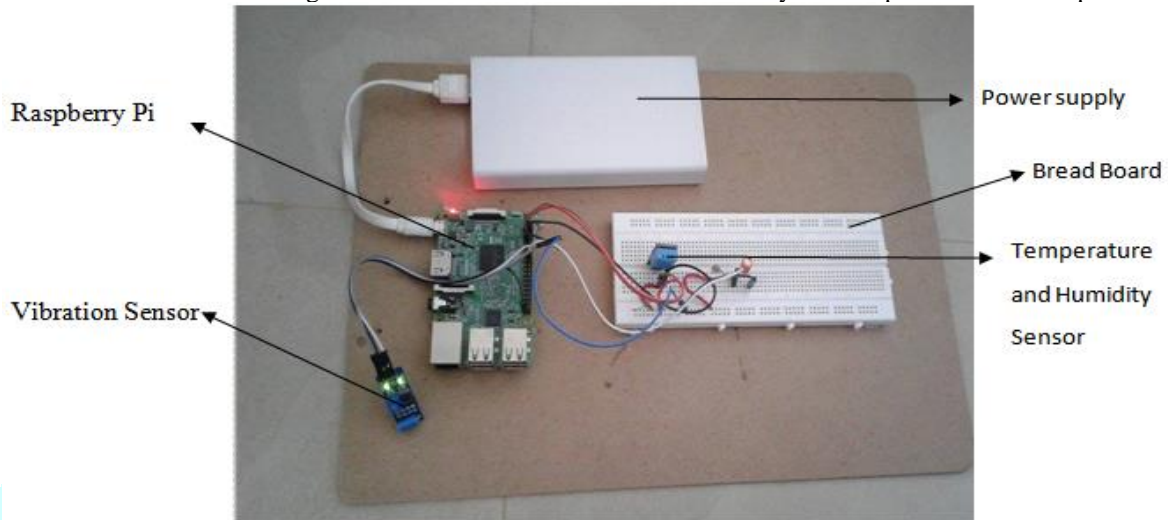

Fig.3 Working Experimental setup for CSMS

The above screenshot tells about our project setup connection i.e. civil structures health monitoring system

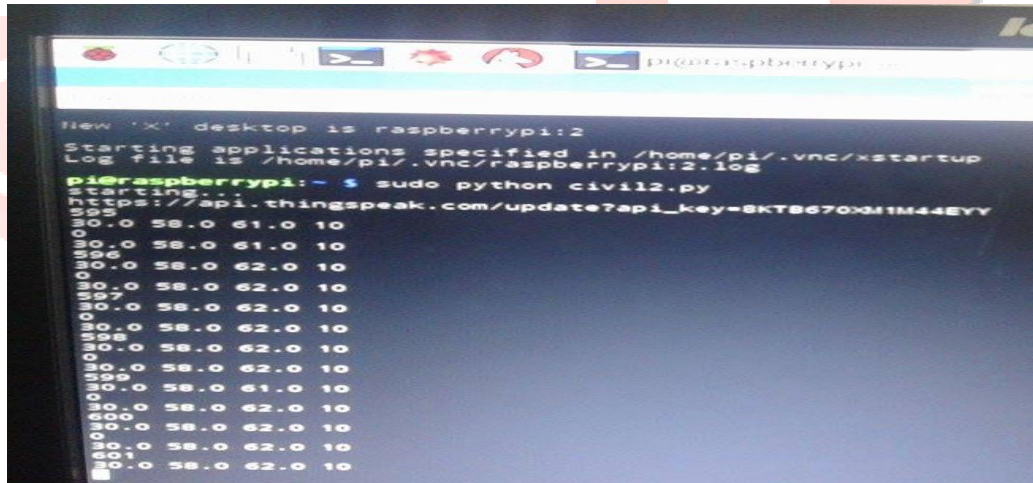

Fig.4 Display of Sensors Data

The above screenshot tells that after installation of putty software we can see the real time data detection of sensors. i.e., vibration sensor, humidity sensor, LDR  
eg: 30.0 58.0 62.0 10

where

- 30.0 indicates that the atmospheric temperature in Celsius.
- 58.0 indicates that the atmospheric temperature in Fareinnheat.
- 62.0 indicates that the atmospheric humidity in ppm.
- 10 in which
  - 1 indicates the light.
  - 0 indicates the vibration.



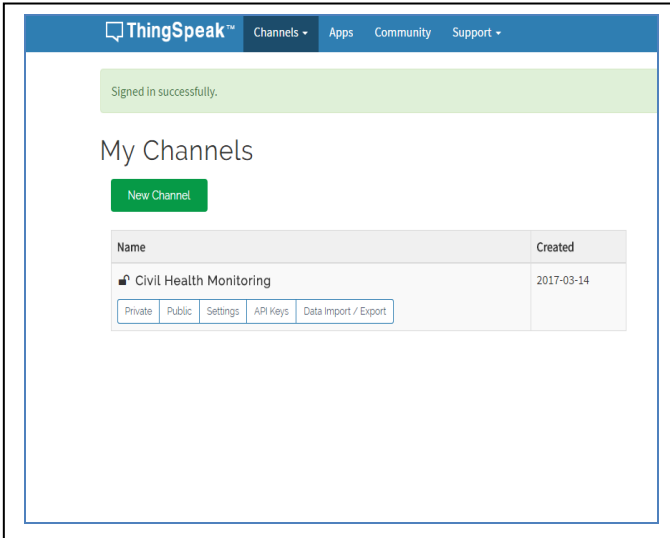

Fig.5 Channel view

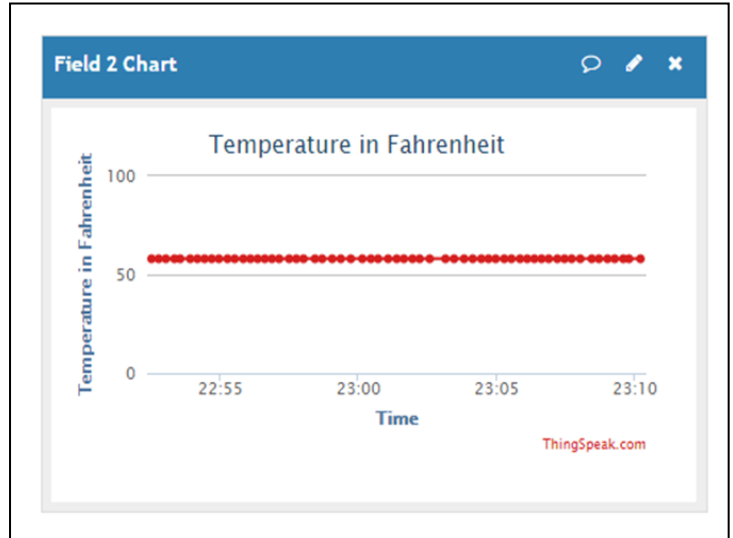

Fig.6 Temperature in Fahrenheit view

The above figure shows the civil health monitoring channel. Click on that channel. Then we will see our output waveforms.

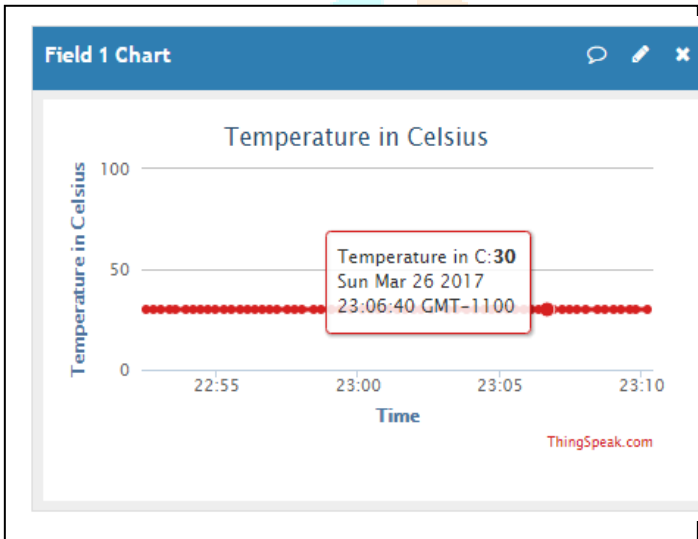

Fig.7 Temperature in Celsius view

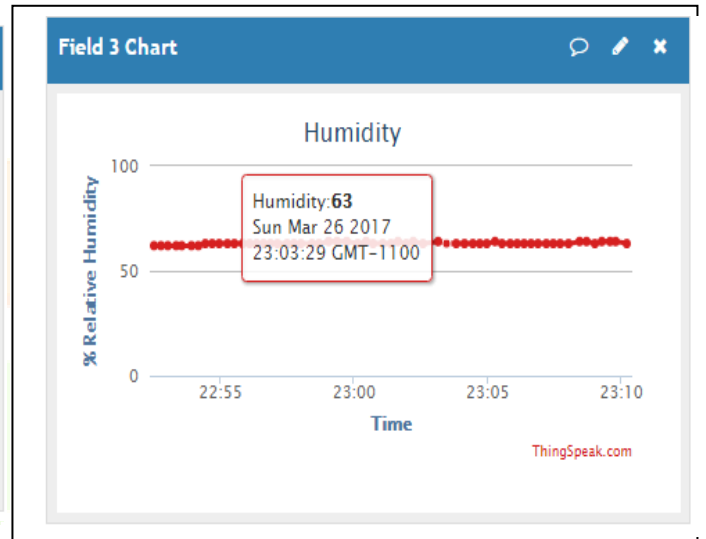

Fig.8 Humidity plot

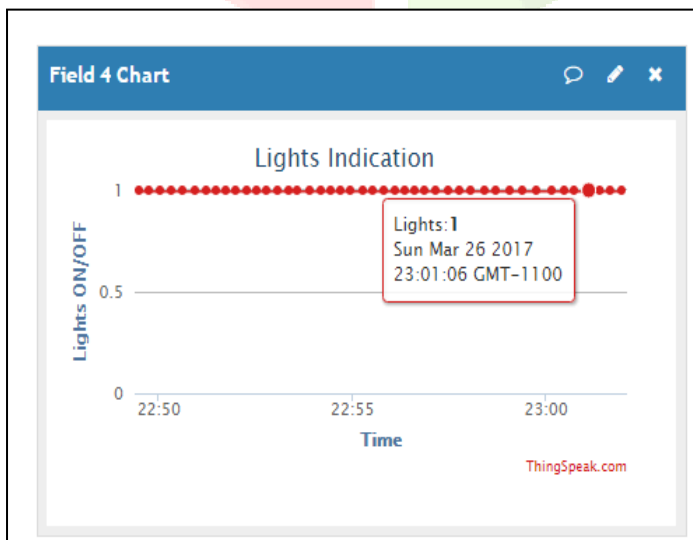

Fig.9 Light plot

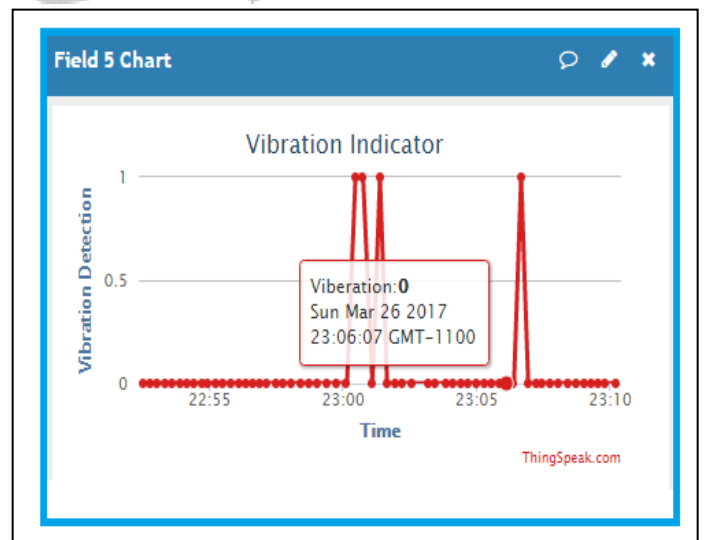

Fig.10 Vibration plot

### VII. CONCLUSION

This project presents the design and the implementation of a civil structure monitoring with smart wireless sensor network using IOT platform. Web based monitor and automatic control of equipment are forming a trend in structures field. Replacing PC with low-cost single chip processor which can make administrators to get parameters of different remote devices

and send control information to field equipments at any time through Internet. The Smart mobile Phone based monitor and automatic control of equipment are forming a trend in structures field. Replacing PC with low-cost single chip processor which can make administrators to get parameters of different remote devices and send control information to field equipment at any time through Internet. The IOT is an excellent choice for this due to its extensive coverage. The complete system is secured through a login E-mail and Webpage. The design is completely wireless and integrated with the software to form a low cost, robust and easily operable system. The E-mail and Web based controlled duplex communication system provide a powerful decision making device concept for adaptation to several civil structures scenarios.

#### REFERENCES

- [1] N. CSU et al., "A Wireless Sensor Network for Structural Monitoring," *Proc. ACM Symp. Networked Embedded Sensing (Sensys)*, ACM Press, 2004, pp. 13–24.
- [2] K. Chintalapudi et.al., "Structures with a Wireless Sensor Network," *Sensor-Network Application, IEEE Internet computing*, www.computer.org/internet/, 2006, 1089-7801/06/ IEEE.
- [3] B. Chen, and M. Tomizuka, Open SHM: open architecture design of structural health monitoring software in wireless sensor nodes. *Proceedings of the IEEE International Conference on Mechatronic and Embedded Systems and Applications (MESA 2008)*, Beijing, China, October 2008, 12-15.
- [4] Shaik Anwar , D. Kishore "IOT BASED SMART HOME SECURITY SYSTEM WITH ALERT AND DOOR ACCESS CONTROL USING SMART PHONE " 2016 International Journal of Engineering Research and Technology (IJERT).
- [5] G. Changsha, A. J A. Rice, and A. Changzhi Li , "Wireless Smart Sensor Network based on Multi-function Interferometric Radar Sensors for Strut", *IEEE Transaction on structural Health Monitoring*, 978-1-4577-1238-8/12 2012.
- [6] G. Feltrin, O. Saukh, J. Meyerand and M. Motavalli, „structural monitoring with WSN: Experiences from field deployments first middles east conference on smart monitoring, 2011; 8-10. <http://www.mdpi.com/journal/sensors>

