

MITIGATE POWER QUALITY PROBLEMS USING D-STATCOM

¹PREM PRAKASH SINGH, ²DR.IMRAN KHAN

¹M.TECH (POWER SYSTEM) ² P.H.D

¹ Electrical Engineering,

¹ Dr. A.P.J. Abdul Kalam Technical University
Lucknow, India

Abstract : Electrical energy is the most popular form of energy and the whole world of society is heavily dependent on the electric supply. Human life cannot be imagined without the supply of electricity. Quality and continuity of the electric power supplied is also very important for all equipment whose operation based on electric supply. But power quality problem associated with power system network due to nonstandard voltage current and frequency that result in failure or misoperation of end user equipment. This paper presents a role of most popular Facts devices known as DISTRIBUTION STATIC COMPENSATOR(D-STATCOM) in power system before fault during fault and after fault condition and analysis power quality of distribution system. When fault occurs in power system at different causes the D-STATCOM will regulate supply voltage by absorbing and providing reactive power to mitigate voltage sag

Key word: Distribution STATCOM (D-STATCOM) Voltage Sags, Voltage source Converter (VSC)

I. INTRODUCTION

Increasing day by day demand for high quality, of electrical power and increasing number of distorting loads at receiving side may leads to an increased power quality problem in power system network. There are many method to improve power quality problems in transmission and distribution systems. one of the most effective devices is D-STATCOM is used to improve power quality . One of most advantages of D –STATCOM is to sustain reactive current at low voltage and develop required voltage and frequency support without capacitor and batteries as energy storage. A D-STATCOM a is custom power device which is used to supplying and absorbing reactive power according to system network required to balanced power quality . Here we use 11 kv distribution system to enhance the power quality such as voltage sags, harmonic distortion . A D-STATCOM is always connected in shut with load.

D-STATCOM:

A D-STATCOM is a shunt connected device which includes a Voltage Source Converter (VSC) and operating with parallel to the load. A D-STATCOM is a reactive power compensation device that is capable of generating and absorbing reactive power according to system requirement to balance power quality and control of output parameter.

A D-STATCOM includes voltage source converter (VSC) and a DC link DC link capacitor connected in shunt, this capacitor capable of generating and /or absorbing reactive power. This D.C. capacitor is chard converter or by battery source . A D- STATCOM performing all the maintenance of power quality in steps .

- 1- If output voltage of voltage source converter voltage(VSC) is greater than A.C. terminal voltage then D-STATCOM operating in capacitive mode and vice versa.
- 2- If voltage source converter(VSC)output voltage is equal to A.C. system supply then no reactive power transfer takes place.

Figure 1 shown simplest form of D –STATCOM

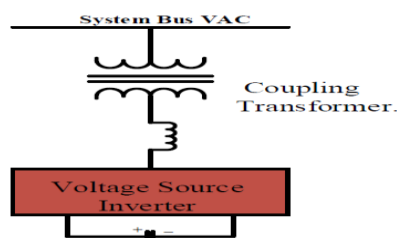

3 Figure 1: Schematic Diagram of a Basic DSTATCOM .

II. SIMULATION MODEL OF TEST SYSTEM WITH AND WITHOUT D-STATCOM AND ITS OPERATION:

For this simulation model generating unit is 25 kv,50 Hz. The output voltages of generating unit is going to three winding transformer of primary winding.Here a two parallel feeder of 11 kv . In one feeder D STATCOM connected in parallel and followed by circuit breaker other is kept it is. A nonlinear load is connected at finishing

point of feeder where D-STATCOM is connected for controlling purpose PI controller is used. The simulation time is taken between 0.4to 0.9 sec. when circuit breaker is not connected in circuit network then CB2 is closed and D-STATCOM is not performing them. Above figure show Simulation test model.

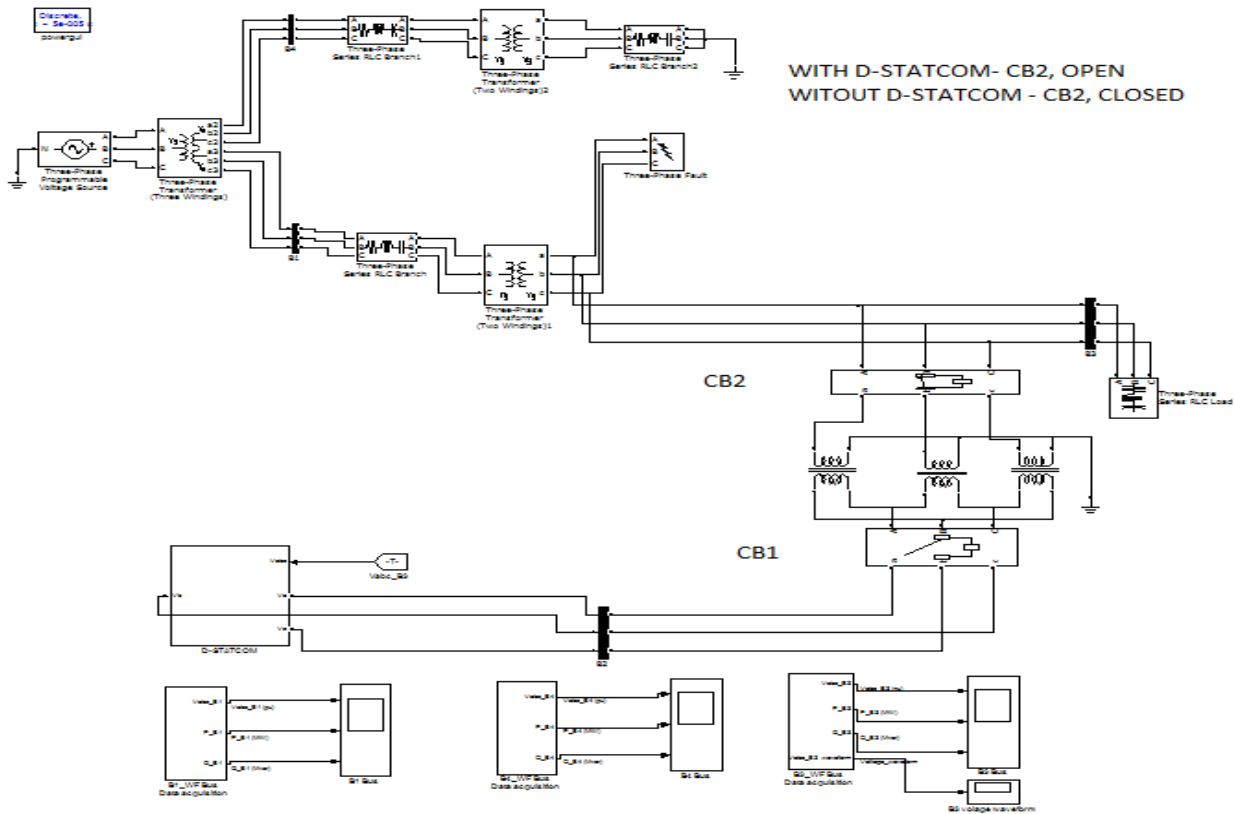

III. PARAMETER OF THE TEST SYSTEM:

This simulation model considered non linear load has been tested on LL fault conditions. This simulation model consist of thee phase programmable voltage source with configuration of 25kv 50 Hz. The source is taken two transmission line through a three phase winding transformer with power rating 250 MVA.

IV. SIMLATON RESULTS: CASE 1. : Double Line Fault (LL) Conditions:

In case Double line fault is considered for both the feeders. Here the fault resistance is 0.001 ohm and the ground resistance is 0.001ohm. The fault is created for the duration of 0.4s to 0.9s. Winding 1: V1rms (Ph-Ph) = 25kv, R1= 0.002(pu), L1 = 0.08002(pu) Winding 2: V2rms (Ph-Ph) = 11kv, R2= 0.002(pu), L2 = 0.08002(pu) Winding 3: V3rms (Ph-Ph) = 11kv, R3= 0.002(pu), L3 = 0.08002 (pu) Inverter Parameter : IGBT based , 3arm , 6 pulse , carrier frequency = 1080Hz. sample time = 5μ sec. the power system, such as CB2 is closed when D-STATCOM is not in operating mode. The output waveform for LL fault is shown below

V. Results Without D-STATCOM (LL Faults):

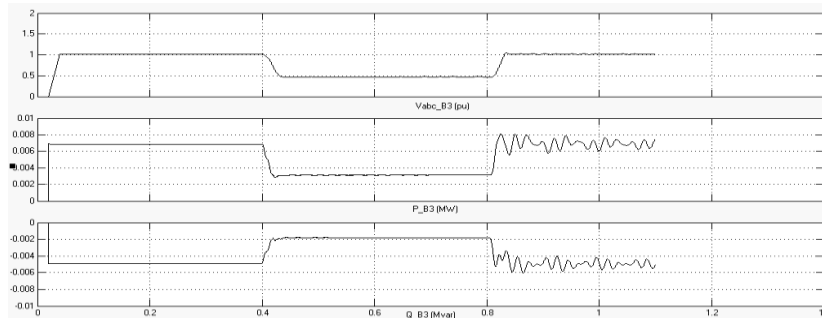

Fig.6.1Three Phase Voltage(pu), Active Power and Reactive Power at Bus 3 Without D-STATCOM (LL Fault)

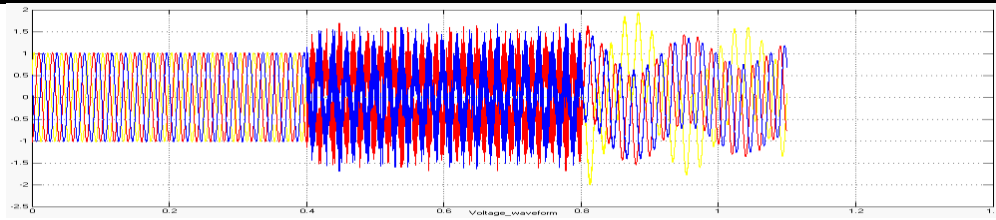

Fig.6.2 Three Phase Voltage Waveform Without D-STATCOM (LL Fault)

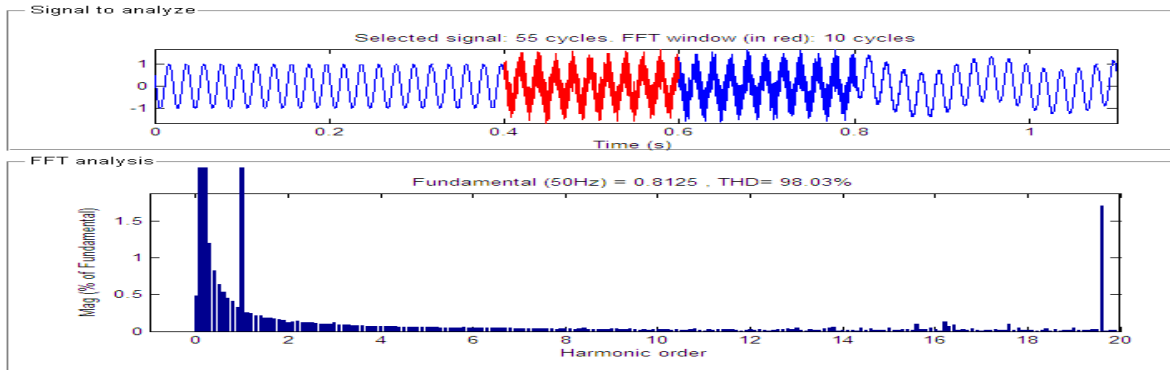

Fig.6.3 FFT Analysis During Without D-STATCOM (LL Fault)

VI. Results With D-STATCOM (LL Faults):

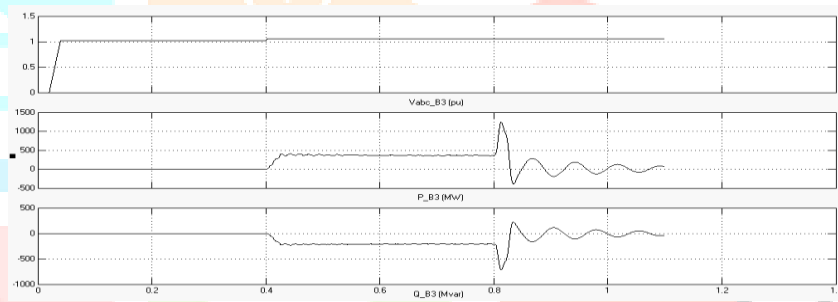

Fig.6.4 Three Phase Voltage(pu), Active Power And Reactive Power At Bus 3 With D-STATCOM (LL Fault)

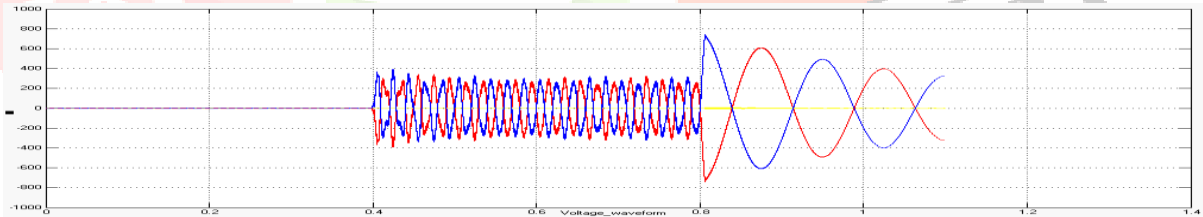

Fig.6.5 Three Phase Voltage Waveform With D-STATCOM (LL Fault)

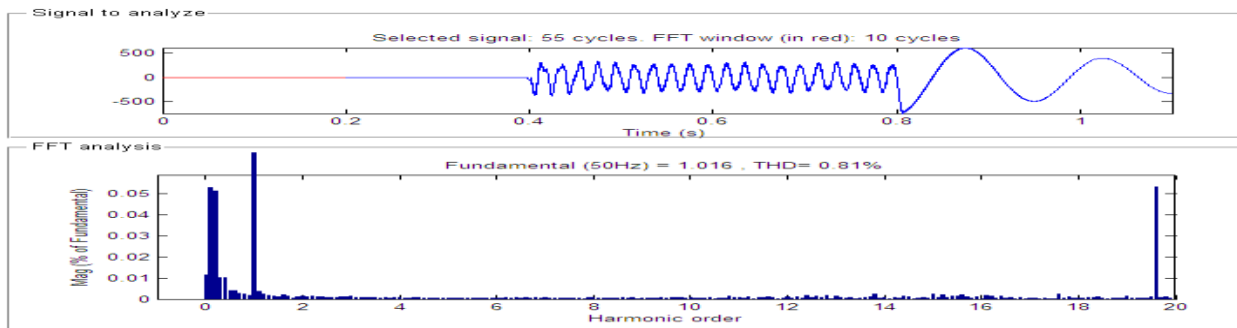

Fig.6.5 FFT Analysis Before Fault With D-STATCOM (LL Fault)

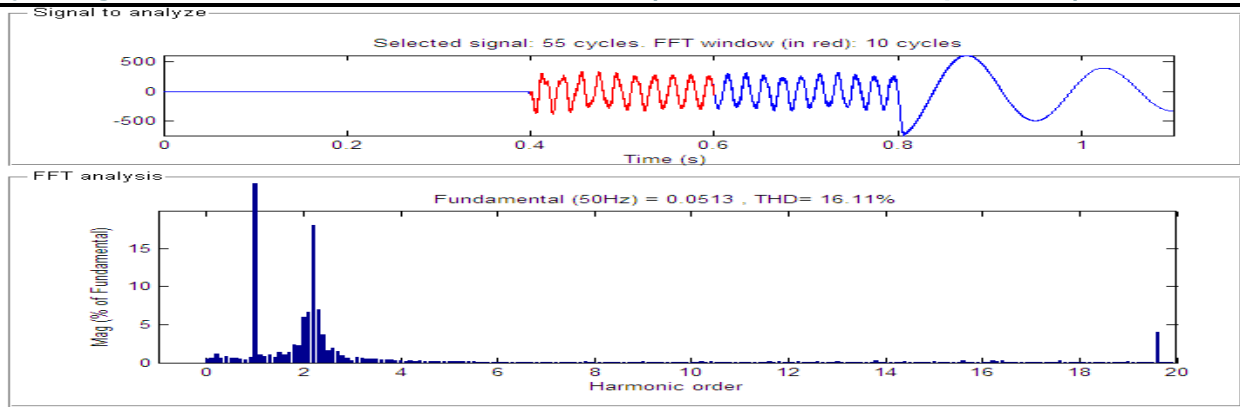

Fig6.7 FFT Analysis During Fault With D-STATCOM (LL Fault)

VII. THD Comparison:

Types of Fault	THD Without D-STATCOM (CB ₂ - Closed)			THD With D-STATCOM (CB ₂ - Open)		
	Before Fault	During Fault	After fault	Before Fault	During Fault	After fault
LL fault	0.18 %	98.03%	2.45 %	0.81 %	16.11%	3.95%

THD comparison With And Without D-STATCOM (LL Faults)

VIII. CONCLUSION:

This paper shown when LL fault occurs in a power system . The receiving side of distribution system voltage will effect the system performances. when we used D-STATCOM at duration of fault occurring in power system .The system voltage power quality problem such as voltage dip, voltage swell and interruption etc, will reduce and system performances is increases.

IX. REFERENCES:

- X. 1.Morden power system analysis. D.P. khotari I.J.Nagrath. 2. Understaing facts concept and Technology. nairain G.Hingorani. and Haszdo Gyugyi. 3. Power Quality Improvement in Distribution system using DSTATCOM in transmission lines by Sai Kiran Kumar Sivakotti, Y.Naveen Kumar, D.Archana. 4. Applications of DSTATCOM Using MATLAB/Simulation in Power System Bhattacharya Sourabh NIIIST Bhopal, MP, INDIA 5 .Static Synchronous Compensator for Improving Performance of Power System: a Review Ghazanfar ShahgholianI, Jawad Fai

XI. 9-BIOGRAPHY

1-Dr. Imran khan (Professor) Azad Institute of Engineering and Technology lucknow.

2-Prem Prakash Singh passed B.Tech (Electrical And Electronics Engineering)from Kali Charan Nigam Institute of Technology Banda in 2013 And pursuing M.tech in Azad Institute of Engineering and Technology lucknow .My currently work on the Placement And Performance Analysis Of D- Statcom For Power Quality MAINTENACE.

