

# Analysis of Variations in Irradiance for Mono-Crystalline and Poly-Crystalline PV Cells

<sup>1</sup>Digvijay Sarvate, <sup>2</sup>M. K. Bhaskar, <sup>3</sup>Deepak Bohra,

<sup>4</sup>Dharmendra Jain and <sup>5</sup>Manish Parihar

<sup>1,3,5</sup>ME Scholar, <sup>2</sup>Professor, <sup>4</sup>PhD Scholar

<sup>1,2,3,4,5</sup>Deptt of Electrical Engg, JNV University, Jodhpur, Rajasthan-India

**Abstract :** A mathematical model of a Photovoltaic (PV) cell used MATLAB-SIMULINK environment, is developed and presented. Modeling and simulation are done for Monocrystalline panel and Polycrystalline panel of 280 Watt. For both types of panels electrical characteristics are plotted and effect of irradiance is analyzed. During modeling and simulation the PV cell temperature is maintained constant at 25° C and the irradiance is varied. Further MATLAB/simulink is done to analyze effect of variations in irradiance. Power is observed at different levels of the irradiance using MATLAB/simulink. In this paper, both the panels are compared on the basis of the different levels of the irradiance at constant 25° C temperature.

**Keywords** - Matlab, SIMULINK, Photovoltaic Module, standard test condition (STC), mathematical model.

## I. INTRODUCTION

Conventional energy sources are unable to meet the increasing demand for energy worldwide. So, alternative energy sources like sunlight, wind and biomass come into picture. In that context, photovoltaic energy is a source of interesting energy; it is renewable, inexhaustible and non-polluting, and it is used as energy sources in various applications. In this paper, modelling of photovoltaic cells (60 Cells Mono Somera and Eldora Ultima Silver 1500 V Series by Vikram Solar) of 280 watts by matlab/simulink is done. The output quantities (Voltage, current and power) vary as a function of irradiation, temperature and load current. The effects of these three variations are considered in the modeling. The analysis of photovoltaic model proposed in this paper is circuitry based model to be used with simulink. Here module is modelled and P-V & I-V characteristics are plotted for different irradiances (1000W/m<sup>2</sup>, 900 W/m<sup>2</sup>, 700 W/m<sup>2</sup> and 500 W/m<sup>2</sup>) at constant temperature 25°C for Monocrystalline and Polycrystalline panels. This study also compares simulation results with the datasheets of 60 Cells Mono Somera and Eldora Ultima Silver 1500 V Series by Vikram Solar panels. The results show model's accuracy. The objective of this paper is to develop well clear and understandable MATLAB-Simulation PV model in which the irradiance levels and constant temperature form key factors.

## II. A PHOTOVOLTAIC MODULE AND ITS GOVERNING EQUATIONS

Solar Module consists of solar cell. Solar cell is basically a p-n junction fabricated in a thin wafer or layer of semiconductor. The photovoltaic modules are made up of silicon cells. The silicon solar cells give output voltage of around 0.7V under open circuit condition. When large many such cells are connected in series we get a solar PV module. The current ratings of the modules depend on the area of the individual cells. Higher the cell area, higher is the current output of the cell, to obtain higher power output; the solar PV modules are connected in series and parallel combinations forming solar PV arrays. When the PV Cells are exposed to the sunlight, photons with energy higher than the band-gap energy of the semiconductor are absorbed and create some electron-hole pairs proportional to the incident irradiation. With the influence of the internal electric fields of the p-n junction, these carriers are pulled apart and create a photo-current which is proportional to solar isolation. PV system naturally exhibits a nonlinear V-I and P-V characteristics which vary with the irradiance (insolation) at standard test conditions (STC). The governing equations for Monocrystalline and Polycrystalline panels (60 Cells Mono Somera and Eldora Ultima Silver 1500 V Series by Vikram Solar) of 280 Watt given below:

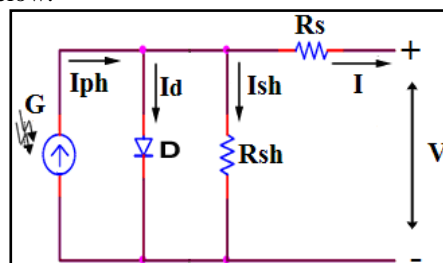

**Fig.1:** Equivalent circuit of PV cell.

$$I_{ph} = [I_{SC} + K_i(T_c - T_r)] * \frac{S}{1000} \quad (1)$$

$$I_{rs} = I_{SC} / [\exp\left(\frac{qV_{oc}}{N_S k A T_c}\right) - 1] \tag{2}$$

$$I_S = I_{rs} \left[\frac{T_c}{T_r}\right]^3 \exp\left(\frac{qE_g}{kA\left(\frac{1}{T_r} - \frac{1}{T_c}\right)}\right) \tag{3}$$

$$I_{pv} = N_p * I_{ph} - N_p * I_S \left[ \exp\left(\frac{qV_{pv} + I_{pv} R_S}{N_S k A T_c}\right) - 1 \right] \tag{4}$$

Where,  $I_{ph} = G$  = photo current,  $I_{rs}$  = reverse saturation current,  $I_S = I_D$  = Saturation current,  $I_{pv}$  = output current ,  
 $N_p$  = No. of parallel branches of the cells,  $A$  = Diode Ideality Factor,  $k$  = Boltzmann’s Constant =  $1.3805 \times 10^{-23} \text{ J/K}$ ,  $K_i$  = Short Circuit Temperature Coefficient in  $\text{mA}^\circ\text{C}$ ,  $N_S$  = Number of Cells Connected in series,  
 $q$  = Magnitude of Charge on the Electron =  $1.6 \times 10^{-19} \text{ C}$ ,  $R_S$  = Series Resistance ( $\Omega$ ),  $R_{sh}$  = Shunt Resistance ( $\Omega$ ),  
 $S$  = Solar irradiation Intensity ( $\text{W/m}^2$ ),  $T_c$  = Working Cell Temperature (K),  $T_r$  = Reference Temperature = 298 K  
 and  $V_{oc}$  = Open Circuit Voltage (V).

**III. REFERENCE MODEL FOR PHOTOVOLTAIC MODULE**

60 Cells Mono Somera and Eldora Ultima Silver 1500 V Series by Vikram Solar panels of 280 watts are taken as the reference models for the comparative study of simulation results using above equations [(1) to (4)]. The datasheets of both the PV panels are given below:

**Table 1:** Datasheet at STC:  $1000 \text{ W/m}^2$  irradiance,  $25^\circ\text{C}$  cell temperature for Mono-Crystalline PV Cell

**Table 2:** Datasheet at STC:  $1000 \text{ W/m}^2$  irradiance,  $25^\circ\text{C}$  cell temperature for Poly-Crystalline PV Cell

Parameters	Values
Peak Power	280 W
Open Circuit Voltage	39.5 V
Short Circuit Current	9.24 A
Temp. Coeff. for Short Circuit Current	0.00053
NOCT	$45^\circ\text{C} \pm 2^\circ\text{C}$

Parameters	Values
Peak Power	280 W
Open Circuit Voltage	38.7 V
Short Circuit Current	9.32 A
Temp. Coeff. for Short Circuit Current	0.00058
NOCT	$45^\circ\text{C} \pm 2^\circ\text{C}$

**IV. A SIMULATED MODEL OF PHOTOVOLTAIC MODULE**

A generalized PV model is built using Matlab/Simulink according to Equations (1) to (4). Solar module [60 Cells Mono Somera and Eldora Ultima Silver 1500 V Series by Vikram Solar panels of 280 watts] are taken as a reference model for simulation results. The proposed model is also implemented using Matlab/Simulink along with P-V & I-V characteristics.

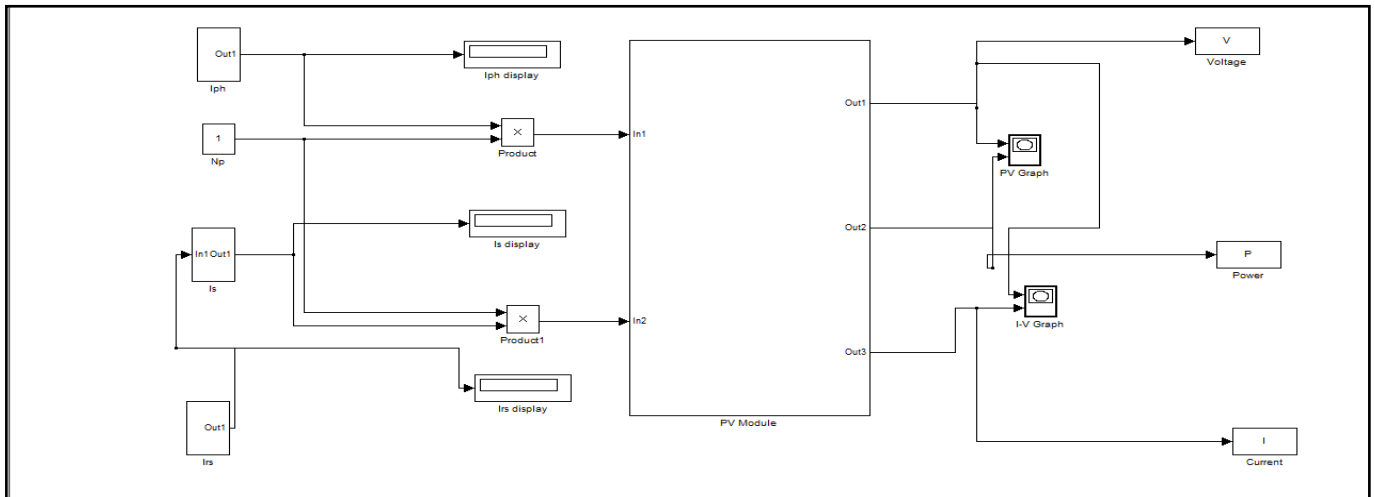

Fig.2: Simulink Model of PV cell.

V. SIMULATION RESULTS

There are simulation results of 60 Cells Mono Somera and Eldora Ultima Silver 1500 V Series by Vikram Solar panels of 280 watts on the basis of comparison as shown in figures below. Both the P-V and I-V characteristics of 60 Cells Mono Somera and Eldora Ultima Silver 1500 V Series by Vikram Solar panels of 280 watts are compared. A comparison table has also been given after the simulation results.

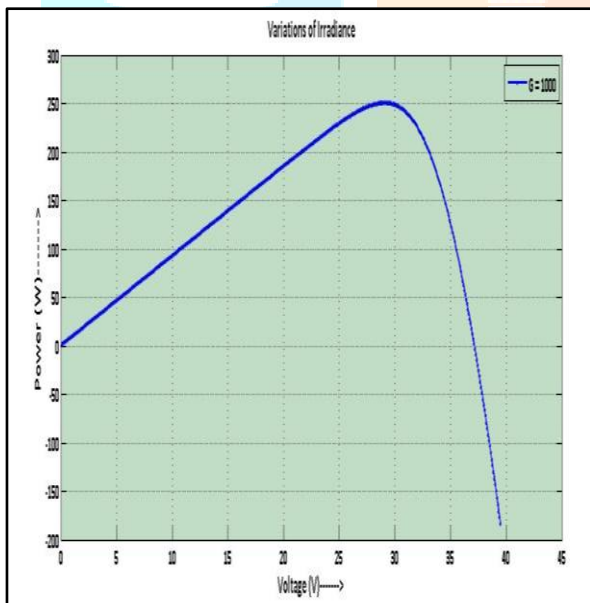

Fig.3: PV Graph for Irradiance at  $G=1000 \text{ W/m}^2$  for Mono Crystalline PV Cell

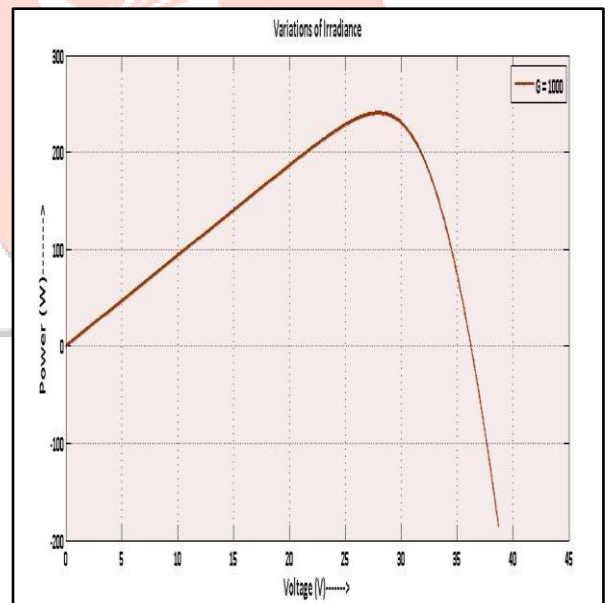

Fig.4: PV Graph for Irradiance at  $G=1000 \text{ W/m}^2$  for Poly Crystalline PV Cell

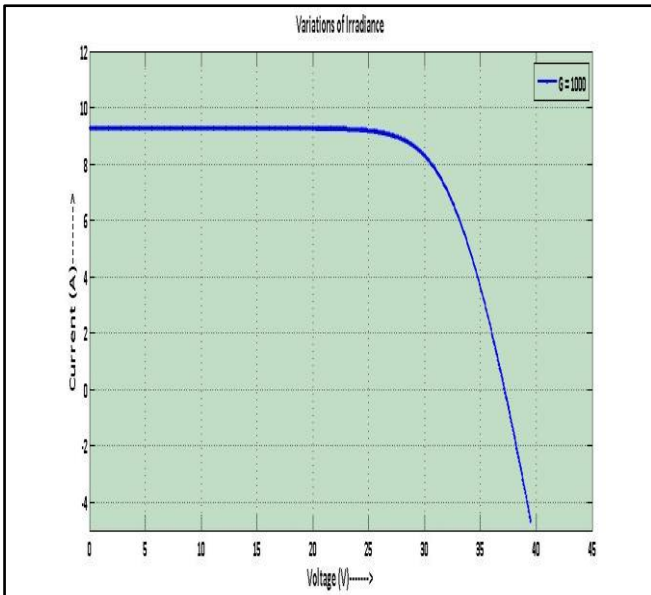

Fig.5: I-V Graph for Irradiance at  $G=1000 \text{ W/m}^2$  for Mono Crystalline PV Cell

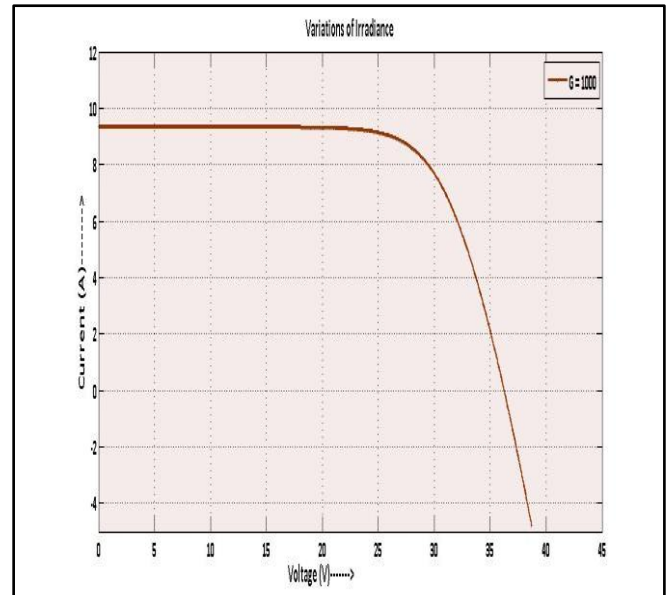

Fig.6: I-V Graph for Irradiance at  $G=1000 \text{ W/m}^2$  for Poly Crystalline PV Cell

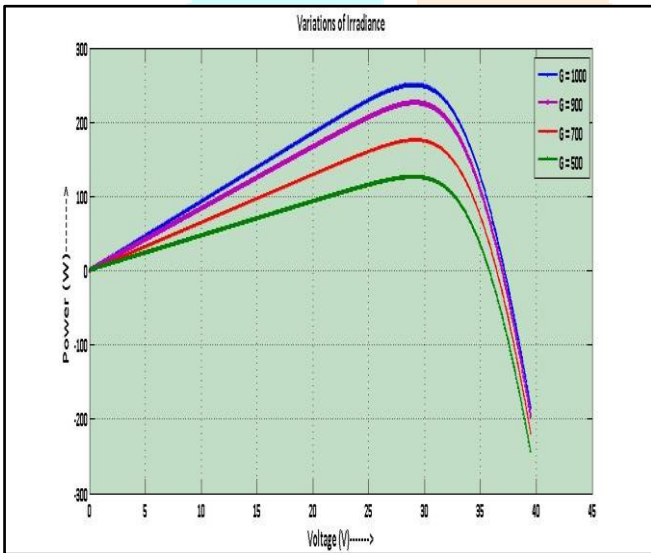

Fig.7: PV Graph for Irradiance at  $G=500 \text{ W/m}^2$  for Mono Crystalline PV Cell

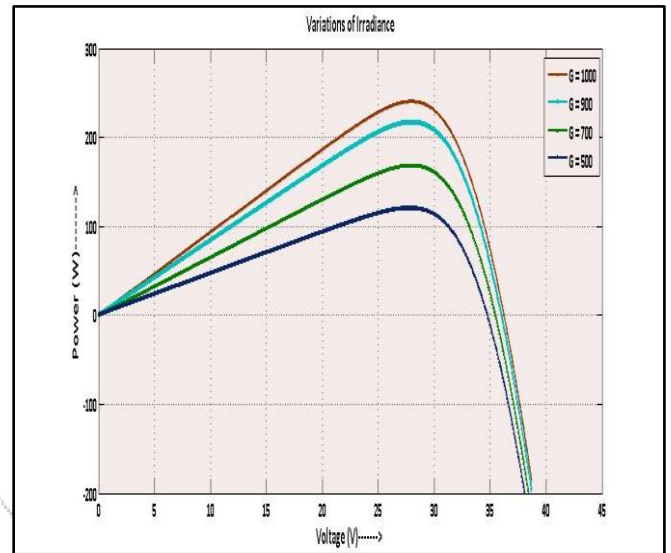

Fig.8: PV Graph for Irradiance at  $G=500 \text{ W/m}^2$  for Poly Crystalline PV Cell

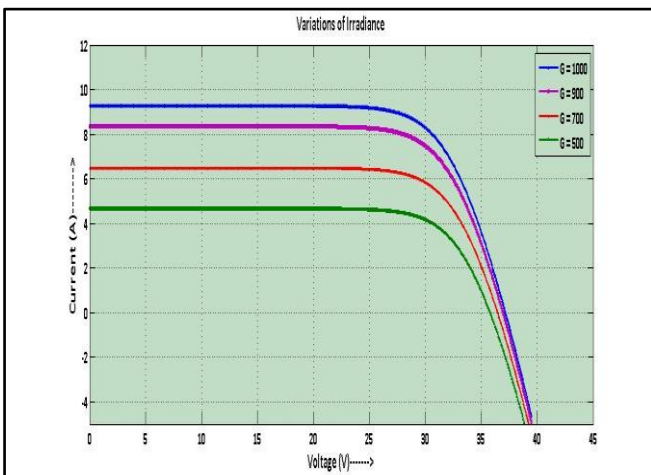

Fig.9: I-V Graph for Irradiance at  $G=500 \text{ W/m}^2$  for Mono Crystalline PV Cell

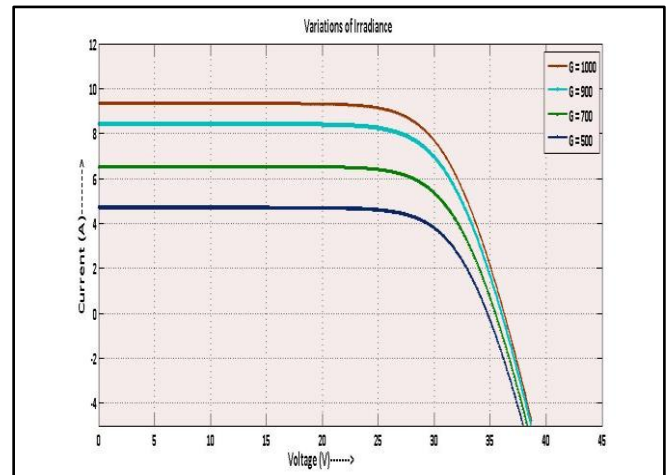

Fig.10: I-V Graph for Irradiance at  $G=500 \text{ W/m}^2$  for Poly Crystalline PV Cell

**Table 3:** Values of Max. Power and Current at Different Levels of Irradiance at 25°C for 60 Cells Mono Somera Ultima Silver 1500 V Series by Vikram Solar panels

Irradiance(W/m <sup>2</sup> )	Max. Power (Watts)	Max. Current (Ampere)
1000	250.01 W	9.24 A
900	225.60 W	8.37 A
700	175.90 W	6.48 A
500	125.23 W	4.63A

**Table 4:** Values of Max. Power and Current at Different Levels of Irradiance at 25°C for 60 Cells Eldora Ultima Silver 1500 V Series by Vikram Solar panels

Irradiance(W/m <sup>2</sup> )	Max. Power (Watts)	Max. Current (Ampere)
1000	240.35 W	9.32 A
900	216.76 W	8.40 A
700	168.78 W	6.53 A
500	119.91 W	4.67 A

**Table 5:** Comparative Values of Max. Power and Current at Different Levels of Irradiance at T= 25°C for Mono and Poly Crystalline Cells

Irradiance(W/m <sup>2</sup> )	Max. Power (Watts)		Max. Current (Ampere)	
	Mono Crystalline	Poly Crystalline	Mono Crystalline	Poly Crystalline
G				
1000	250.01 W	240.35 W	9.24 A	9.32 A
900	225.60 W	216.76 W	8.37 A	8.40 A
700	175.90 W	168.78 W	6.48 A	6.53 A
500	125.23 W	119.91 W	4.63 A	4.67

The table 5 shows the comparative study of mono and poly crystalline PV Cells. It shows the maximum power and current at the different levels of irradiance at 25°C temperature. As it can be seen that the power and current decrease along with decreasing values of irradiance.

**VI. CONCLUSION**

Figures and tables show the simulation results of P-V & I-V characteristics for the variations in solar irradiance. Irradiance variations range starts from 1000W/m<sup>2</sup>, 900 W/m<sup>2</sup>, 700W/m<sup>2</sup>, 500W/m<sup>2</sup>. The variations of irradiance are investigated with constant module temperature 25°C. This analysis and study are performed for 60 Cells Mono Somera and Eldora Ultima Silver 1500 V Series by Vikram Solar panels of 280 watts. The P-V and I-V curves of the Monocrystalline and polycrystalline solar panels are highly dependent on the solar irradiation values. It is very clear that current generated and maximum output power decrease with decreasing solar irradiance values. The accurateness of the simulation results is verified with manufacturer results P-V and I-V characteristics of Mono and Poly Crystalline PV Cells. In this paper, the Mono-Crystalline PV Cell is better than the Poly-Crystalline PV Cell on the basis of comparison. The comparison of Mono Somera and Eldora Ultima Silver 1500 V Series solar panels is done with respect to the power and current respectively.

**REFERENCES**

[1] Awodugba, A. O., Sanusi, Y. K., and Ajayi, J. O., “Photovoltaic solar cell simulation of shockley diode parameters in matlab”, International Journal of Physical Sciences, Vol. 8(22), pp. 1193-1200, 16 June, 2013.

[2] Chetan Singh Solanki, Solar Photovoltaics, PHI publication.

[3] Dev,A. and Jeyaprabha, S.B. 2013. Modeling and Simulation of Photovoltaic Module in MATLAB,Proceedings of the International Conference on Applied Mathematics and Theoretical Computer Science:268-273.

[4] Digvijay Sarvate, M.K. Bhaskar et.al.” Effect of Irradiance on Performance for Poly-Crystalline Photo-voltaic Cell”, International Journal of Engineering and Techniques (IJET), ISSN: 2395-1303Vol. 3, Issue 6, Nov-December, 2017.

[5] Digvijay Sarvate, M.K. Bhaskar et.al.” Performance of Mono-Crystalline Photo-voltaic Cell on the Variations of Irradiance”, International Journal For Science And Advance Research In Technology (IJSART), ISSN [ONLINE]: 2395-1052Vol. 3, Issue 12 in December, 2017.

- [6] Dunford ,W.G., Xiao,W. and Capel, A. 2004. A Novel Modeling Method for Photovoltaic Cells, 35<sup>th</sup> Annual IEEE Power Electronics Specialists Conference: 1950-1956.
- [7] H. Mahamudul, M. Saad, and I. Henk, “A Modified Simulation Method of Photovoltaic Module in Simulink Environment,” no. 1, pp. 607–610, 2012.
- [8] Habbati Bellia, Ramadani Yousef, Moulay Fatima, “A detailed modeling of photovoltaic module using MATLAB”, NRIAG journal of Astronomy and Geophysics, (2014)3, 53-61.
- [9] Pandiarajan, N. and RanganathMuthu. 2011. Mathematical Modeling of Photovoltaic Module with Simulink, International Conference on Electrical Energy Systems, 314-319.
- [10] S. Sheik Mohammed. 2011. Modeling and Simulation of Photovoltaic module using MATLAB/Simulink, International Journal of Chemical and Environmental Engineering, Vol.2, Issue5:350-355.
- [11] Salmi,T., Bouzguenda ,M., Gastli,A., and Masmoudi, A. 2012. MATLAB/Simulink Based Modelling of Solar Photovoltaic Cell, International Journal of Renewable Energy Research, Vol.2, and No.2: 213-218.
- [12] Soumyadeep Ray. 2013. Mathematical Modeling of Photovoltaic System And Study of Various Characteristics By this Model, International Journal of Electrical Engineering Research & Applications (IJEERA), Vol. 1, Issue 3: 9-16.
- [13] Sudeepika, P and Khan, G. March 2014. Analysis of Mathematical Model of PV Cell Module in MATLAB/Simulink Environment, International Journal of Advanced Research in Electrical, Electronics and Instrumentation Engineering, Vol. 3:7823-7829.
- [14] T. Marnoto, K. Sopian, W. A. N. Ramli, and W. A. N. Daud, “Mathematical model for determining the performance characteristics of multi-crystalline photovoltaic modules,” International Conference on Mathematical and Computational Methods in Science and Engineering , pp. 79–84, 2007.
- [15] Tsai, C.S. Tu, and Y.J. Su .2008. “Development of generalized photovoltaic model using Matlab/Simulink,” Proceedings of the World Congress on Engineering and Computer Science.
- [16] Venkateswarlu, G. and Raju, P.S. 2013. Simscape model of photovoltaic cell, International Journal of Advanced Research in Electrical, Electronics and Instrumentation Engineering, Vol. 2, Issue 5: 1766-1772.
- [17] Villalva,M.G., Gazoli,J.R. and Filho,E.R.2009. Modeling and circuit-based simulation of photovoltaic arrays, IEEE: 1244-1254.

