



INTERNATIONAL JOURNAL OF CREATIVE RESEARCH THOUGHTS (IJCRT)

An International Open Access, Peer-reviewed, Refereed Journal

DESIGN AND ANALYSIS OF OPTIMAL SIZING OF WATER TREATMENT PLANT BY MCDM TECHNIQUE

¹ Ishwar Lal Tavare, ² Ashutosh Pandey,

¹Reserch Scholar, ²Assistant Professor,

¹Civil Engineering, ¹Civil Engineering, ¹Civil Engineering

¹Mats School of Engineering & Information Technology, Raipur, India

²Mats School of Engineering & Information Technology, Raipur, India

Abstract: The study identifies the most important water quality parameter and location selection parameter, as well as the suitability index of two sites in Raipur, C.G.: Chandandih WTP and Nimora WTP. Now a days many water resources are polluted by anthropogenic sources including household and agricultural waste and industrial processes. Public concern over the environmental impact of wastewater pollution has increased. several conventional wastewater treatment techniques, i.e. Chem- ical coagulation, adsorption, activated sludge, have been applied to remove the pollution, however there are still some limitations, especially that of high operation costs. Waste water treatment can be defined as a process of removing organic and inorganic matter from the wastewater to make it suitable to be discharged back to the environment. Rainwater entering drains and industrial wastes also appear to fit under this category.

Index Terms - WTP, Waste water, MCDM, rain water.

I. INTRODUCTION

A rapid growth in population is now being seen. The more people there are, the more fundamental necessities are necessary. Water is one of the most fundamental requirements, and it is regarded as the most crucial. Only 2.5 percent of the water on this island is fresh, therefore it cannot meet 100 percent of the standards. As a result, it is our job to treat and make potable the remaining water on the planet. We'll need to build surface water treatment plants to treat the water and provide it to the homes.

This method is suitable for large and old city with considerable development. If it is used for small, average or comparatively new cities, it will give lower population estimate than actual value .In this method the average increase in population per decade calculated from the past census reports.

II. MOTIVATION OF THE STUDY

The motivation for treatment of waste water are manifold. Treatment and re-use of waste water- conserves the supply of fresh water and this represents clear advantages with respect to environmental pollution. So the main aim of this project is to plan, Design a waste water treatment plant for Raipur city.

III. METHODOLOGY

3.1 Forecasting of Population

3.1.1 Arithmetic Increase Method

This method is suitable for large and old city with considerable development. If it is used for small, average or comparatively new cities, it will give lower population estimate than actual value .

This method is based on the assumption that population is increasing at a constant rate

The rate of change of population with time is constant. The population after 'n' decades can be determined by the formula

$$P_n = P + n X c \text{ where,}$$

p = population at present n = no.of decades

c = constant determined by the average of increase of 'n' decades.

For future years

$$P(2021) = P(2011) + n \times c \quad P(2021) = 2,12,640 + 1 \times 33,942$$

$$P(2021) = 2,46,582$$

$$P(2031) = P(2021) + n \times c \quad P(2031) = 2,46,582 + 1 \times 33,942$$

$$P(2031) = 2,80,524$$

So, for the present study, planning and design for treatment plant is carried out for population of 280524.

3.2 Quantity of Sewage

1. Quantity of water = future year population \times per capital per day liters

$$= 2,80,524 \times 135 \text{ liters/day}$$

$$= 3,78,81,000 \text{ liters/day}$$

$$= 37881 \times 10^3 \text{ liters/day}$$

$$= 37,881 \text{ m}^3/\text{day}$$

$$= 1,878.375 \text{ m}^3/\text{hour}$$

$$= 26.306 \text{ m}^3/\text{min}$$

$$= 0.438 \text{ m}^3/\text{sec}$$

2. Quantity of sewage = 80percent of water that is supplied

$$= 0.8 \times 2,80,524 \times 135 \times 1.5$$

$$= 45.44 \times 10^6 \text{ lit/day}$$

$$= 45.44 \times 10^3 / 24 \times 3600$$

3. Average sewage flow = $0.525 \text{ m}^3/\text{sec}$

$$= 12.62 \text{ m}^3/\text{hr}$$

→ Peak factor: (Range; 2-4)

4. Design of flow capacity = Average sewage flow \times peak factor (m^3/hr)

$$= 12.62 \times 3$$

$$= 37.87 \text{ m}^3/\text{hr}$$

3.3 Size Calculation of Collection pit :

Retention period = 4 hr (Range: 3-6hr :SOURCE:Text Book; M.N.RAO.)

capacity of collection sump = (design of flow capacity \times retention period)

$$= 37.87 \times 4$$

$$= 151.48 \text{ m}^3$$

Assume liquid depth 3 to 6m

Area required for collection pit =

Capacity of Collection Sump

Assume liquid depth

$$= (151.48/6)$$

$$= 25.246 \text{ m}^2$$

If it is circular tank,

$$\rightarrow \pi r^2 = 25.246$$

$$r = 2.83 \text{ m} = 3 \text{ m diameter} = 6\text{m}$$

Volume of the pit provided = $(\pi d^2 / 4) \times$ Liquid depth

$$= \pi \times 6^2 / 4 \times 6$$

$$= 169.64 \text{ m}^3$$

area of pit provided = $\pi \times 6^2 / 4$

$$= 28.27 \text{ m}^2$$

3.4 Design of Bar Screens

Bar Screen catches large objects that have gotten into sewer system such as bricks, bottles, pieces of wood, etc

LOCATION:

The screens are generally located before the grit chambers

CLASSIFICATIONS:

a . Depending upon the size of operations, the screens are classified as:

- Fine screens (mesh type screen size of openings about 1.5 to 6mm).
 - Medium screens (Size of openings 6 to 40mm).
 - Codices screens (Size of opening about 40mm or more).
- b . Depending upon condition of screens they are classified as:
- Fixed screens.
 - Movable screens.
 - Moving screens.

From the above classification of screens, fixed screens are designed in the treatment plant for clear spacing.

3.4.1 Construction and working of fixed screens

The screen consists of parallel 6mm steel bars having 30mm equal spacing between them.

The screens is placed at an angle of 30degrees to horizontal. All the floating solids larger in size than of the openings retained on the screen. They are removed periodically.

3.4.2 Disposal of screenings

:When sewage is passed through screens, the suspended and floating matters larger than the openings of the screens and are removed from sewage. These removed materials are continuously deposited on screens. After some time then the screens becomes partially clogged, they are cleaned and the screenings are taken away for disposal.

Assume Size of the bar = 50mm X 6mm and

Peak discharge = 11300kL (per day) = 11300 m³

(per hr) = 470.83 m³ / hr

Average sewage flow = 12.62 m³ / hr Inclination of bars = 30°

Velocity = 0.3 X capacity of collection sump

= 0.3 X 151.48

= 45.44 m/h/m²

= 470.83 / 45.44(Cross Section Area required = (peak discharge/velocity))

= 10.36 m²

Let liquid depth required = 2m (depth of flow) Required effective width= 10.36 / 2

= 5.18 = 6m

A clear spacing of 24mm between the bar is provided Assume velocity of flow normal top the screen is 30cm/sec

Net Area= Average rate of flow / Velocity =

1.75m³

per MLD)

3.5 Design of Grit Chamber

A grit chamber is an enlarged channel through which sewage is passed through to remove grit.

TYPES:

- Manually cleaned type
- Mechanically cleaned type
- Hydraulically cleaned type

In above types of grit chambers, the manually cleaned type grit chamber is used.

LOCATION:

The manually cleaned type grit chamber is placed before sedimentation and immediately after the screens.

3.5.1 Construction and Working

It is a concrete enlarged channel of 18m long with slightly larger area of flow that the velocity is 0.3m/sec. Two separate chambers are provided, one to take care of minimum flow and another to take care of maximum flow. Here the detention period is 1 minute or 60 seconds. The sewage is allowed into the grit chamber, the velocity of flow is reduced due to increased areas of cross section of flow. At such low velocity all the inorganic grit particles settle down by gravity and are deposited on bottom. When sufficient accumulations of grit takes place it is cleaned by the manual cleaned type method.

3.5.2 Disposal of Grit chamber

Clean grit is without odours. Washed grit may resemble particles of sand and gravel, interspersed with particles of eggshell and other relatively inert materials from the households. Grit washing machine should be employed when the detention time is more and flow of velocity is less. Unless washed, it may contain considerable amount of organic matter. This attracts rodents and insects. The grit should be disposed of by dumping or burying or by sanitary land fill of low lying areas.

$$\begin{aligned} \text{Capacity of grit chamber} &= 0.525 \times 60 \\ &= 32 \text{ m}^3 \end{aligned}$$

$$\text{Surface loading rate} = 1200 \text{ m}^3 / \text{m}^2 / \text{day} \quad (\text{SOURCE: Text book; M.N.RAO.})$$

Surface area =

$$\begin{aligned} &= 45.44 \times 10^3 / 1200 \\ &= 37.86 \text{ m}^3 / \text{m}^2 \end{aligned}$$

Assuming horizontal velocity @ 0.3 m / sec 1 min as detention period

$$\text{Length of grit chamber} = 0.3 \times 60$$

$$= 18 \text{ m (length = 10 to 18m)}$$

$$= 32 / 2 \times 18 \quad (\text{cross section Area of Grit Chamber} = (\text{Capacity of Grit Chamber} / 2 \times \text{length}))$$

$$= 0.9 \text{ m}^2$$

$$\text{Volume of grit chamber} = (\text{avg sewage flow} \times 2.5) \times \text{detention time} \quad \text{Maximum flow} = \text{avg sewage flow} \times 2.5$$

$$= 0.525 \times 2.5 \times 60$$

$$= 78 / 2.5$$

$$= 31.25 \text{ m}^3$$

$$= 78 / 15 (\text{Area})$$

$$= 5.20 / 2.5 = 2.1 \text{ m}^2$$

Provide 2m as width of chamber (liquid depth bar screen=2m) (25 percent increased to accommodate inlet and outlet zone)

→ Volume of grit chamber (15x2x1)

provide 0.3m freeboard +0.25m grit accumulation zone total depth = 1 + 0.55

$$= 1.55 \text{ m}$$

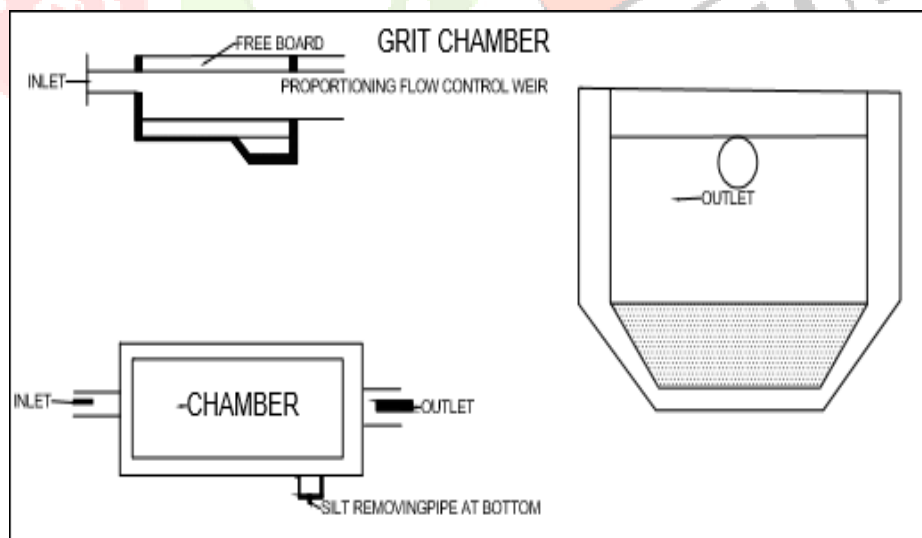

Figure 3.5: Diagram of Grit chamber

3.6 Design of Skimming Tank

3.6.1 Working

The skimming tank consists of a chamber into which sewage is allowed and detained for about 3 minutes and skimmed at bottom. Now the oils, fats and grease are separated from water and they float to the top surface. The floating substances are now collected in the outlet channel and then removed.

3.6.2 Disposal of skimming

The disposal of skimming obtained from the skimming tanks can be done for the manufacture of the soap, lubricants, wax, pitch and other non-edible products. The skimmings are usually disposed of by burning or burying in the ground. If the mineral oils are present in small quantity and more quantity of organic and vegetable oils are present, this can be used in the production of the fuel gas.

$$\text{Surface area required for a tank (A)} = 6.22 \times 10^{-3} \times \frac{q}{V}$$

$$\text{where, } q = \text{rate of flow of sewage} = m^3 / \text{day}$$

$$= 44.44 \times 10^{-3} m^3 / \text{day}$$

$$V_r = \text{Self-cleaning velocity (Minimum raising velocity of oily material to be removed)}$$

$$= 0.25 \text{ m / min}$$

$$A = 0.78 m^2 = 1 m^2$$

SIZE OF THE TANK:

$$\text{Assumed depth} = 3 \text{ m } L : B = 1.5 : 1$$

$$1.5 B^2 = 1$$

$$B = 1 / \sqrt{1.5} = 0.8 \text{ m}$$

$$\text{Size of the tank} = (1.25 \text{ m} \times 0.8 \text{ m} \times 3 \text{ m}) + 0.5 \text{ m (free board)}$$

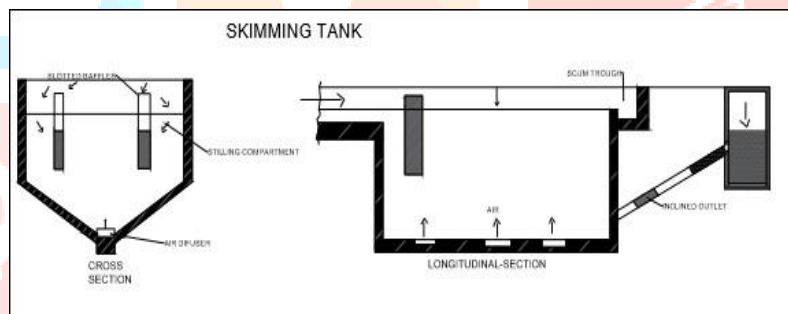

Figure 3.6 : Diagram of Skimming tank

3.7 Design of Primary Setting Tank

Sedimentation tank is also known as settling tank or Clarifier. 2hrs detention time @ average flow

$$\text{Capacity of primary setting tank} = 0.525 \times 60 \times 60 \times 2$$

$$= 3780 m^3$$

$$2 \text{ nos of circular setting tanks of depth (2.5m-5m)} = 3 \text{ m}$$

$$\text{Surface area of each tank} = \frac{\text{Capacity}}{2 \times 3}$$

$$= 630 m^2$$

$$\text{Diameter of tank} = \frac{630}{0.78630 \text{ m}}$$

$$= 800 \text{ m}$$

Wier loading of tank = Average daily flow / area of the tank

$$\frac{45.44 \times 10^3}{4} = 2 \times 10^4 \times 302$$

$$= 32.14 \text{ m}^3 / \text{m}^2 / \text{day}$$

(should be less than 100m³/m²/day Hence it safe for our design

Assuming that grit chamber removes 100PPM of Suspended solids

$$100(450 - 100)$$

$$= 227 \text{ PPM}$$

Assuming that Primary setting tank also remove 30percent of B.O.D3

$$= 230 \times 100$$

$$= 69 \text{ PPM}$$

The effluent coming out from the primary setting tank, will contain suspended solids

$$= 350 - 227$$

$$= 123 \text{ PPM}$$

$$\rightarrow = 230 - 69 = 161 \text{ PPM}$$

Quantity of suspended solids removed =

$$\frac{227 \times 45000 \times 10^3}{106}$$

$$= 10215 \text{ kgm} / \text{day}$$

Assuming tht solid content is only 5 percent

The quantity of sludge = *Quantity of Suspended solids removed Assumed solid conte*

$$= 10215 \times 1005$$

$$= 2,04,300 \text{ kgm} / \text{day}$$

Assuming density of sludge = 1000 kgm / cum

$$\text{Volume of sludge produced} = \frac{\text{Quantity of sludge}}{\text{Density of sludge}}$$

$$204300 / 1000 = 204.3 \text{ cum} / \text{day}$$

Figure 3.7: Diagram of Primary Setting Tank

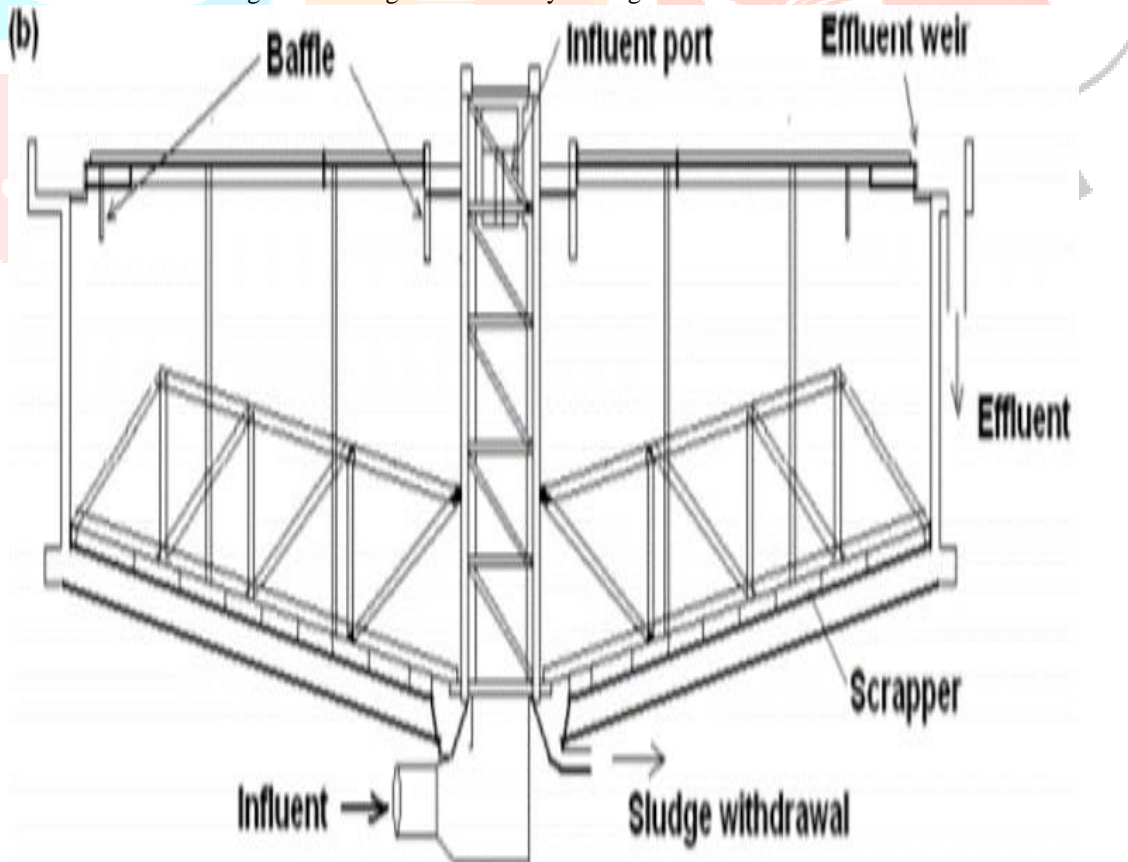

3.8 Design of Aeration tank

B.O.D in the feed sewage = $100 \text{ kg m}^{-3} \text{ day}^{-1}$
 Number of Aeration tank = 1
 Average flow = 350 KLD
 Total B.O.D to the aeration tank = $21.9 \times 24 \times 100$
 $= 52,560 = 52.56 \text{ Kg}$
 MLSS = Mixed Liquor Suspended solids = 1500-3000
 F / M = Food to Microorganisms ratio = 0.4-0.3

Volume of tank required =
 $\frac{350 \times 100}{0.4 \times 2000}$
 $= 43.75 \text{ m}^3$
 Assume liquid depth = 3.0 m (Design criteria) Area = $43.75 / 3.0$
 Area = 14.5 m^2
 Size of the tank = 3.8m X 3.8m X 3.0m

3.9 Design of Secondary Setting Tank

Quantity of effluent to be handled (including recirculation effluent)
 $= 45000 \times 2.5$

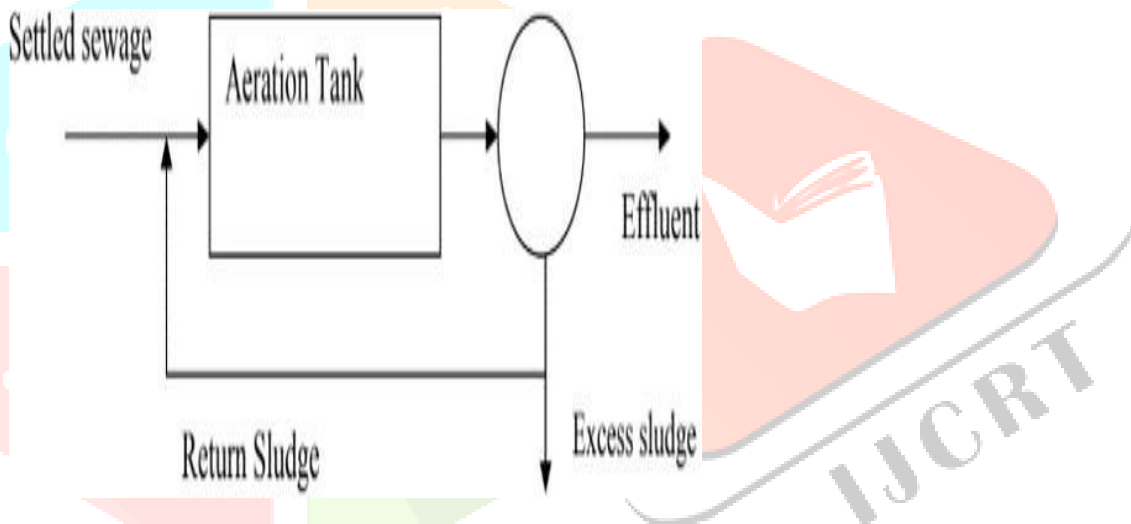

Figure 4.6: Diagram of Aeration Tank

$= 1,12,500 \text{ m}^2 / \text{day}$ Assuming detention period of 2 hrs

Total Capacity of tank = $4 / 24 \times 1,12,500$
 $= 18750 \text{ m}^3$

Assuming 4 no.s radial flow tanks with 3mtrs depth Capacity of each tank = $18750 / 4$
 $= 4687.5 \text{ m}^3$

Diameter of tank:

$$\pi \times d^2 = 187503$$

$$d^2 = \frac{187503}{\pi}$$

$$d = \sqrt{\frac{187503}{\pi}}$$

$$d = 1990$$

$$d = 44.50 = 45 \text{ m}$$

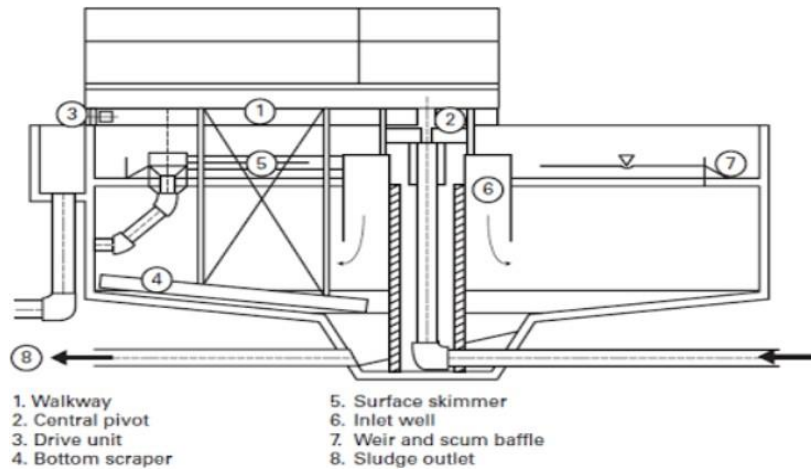

Figure 3.9 : Diagram of Secondary Setting Tank

3.10 Sludge Digestion Tank

Sludge digestion is a biological process in which organic solids are decomposed into stable substances.

Digestion reduces the total mass of solids, destroys pathogens, and makes it easier to dewater or dry the sludge. Digested sludge is inoffensive, having the appearance and characteristics of a rich pottingsozil.

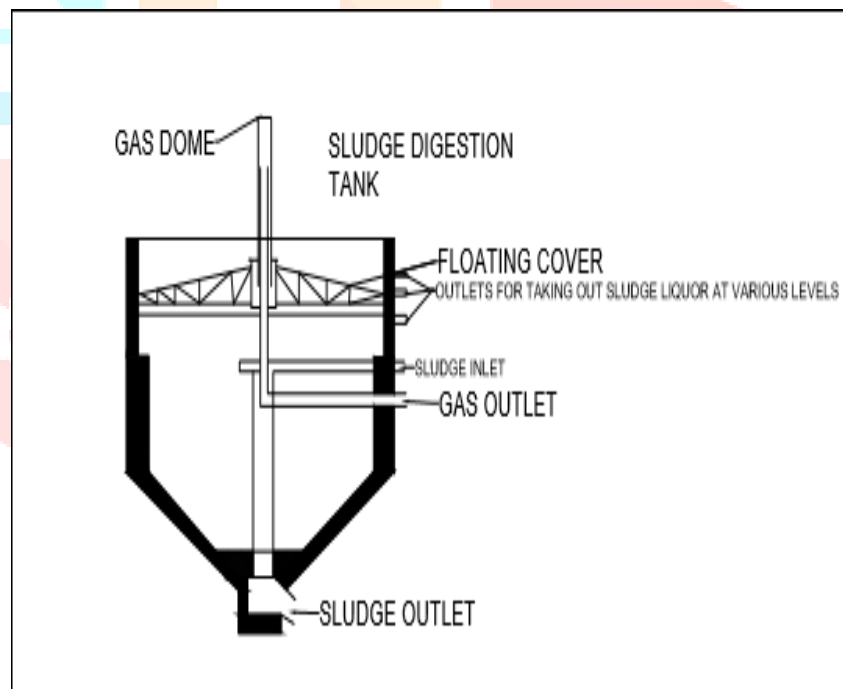

Figure 3.10 : Diagram of Sludge Digestion Tank

3.11 Design of trickling filter

Trickling filters are also known as percolating or sprinkling filters. The trickling filters work on the principle of attached growth process in which the aerobic bacteria, accumulated on the surface of solid medium are employed to iodize the colloidal and dissolved organic substances.

3.11.1 Construction

The trickling filter consist a circular tank with the top opened to atmosphere. The depth of filter medium may be 3m. There is a free circulation of air through the medium i.e. where the medium is plading. The sewage flows through the centrally placed riser pipe from where it goes into the spraying distributors.

The spraying distributors consist of four arms, each arm containing three nozzles. The assembly between the riser pipe and rotary distributors is done with spraying system and mercury seal to avoid any leakage of sewage. An under drain system is provided at the bottom of the tank so as to collect the sewage after trickling over the surfaces to the broken stone.

3.11.2 Working

The sewage is sent to the distributor with sufficient head, it is issued in the form of spray through the nozzles. The equal and opposite reactions to spray jets act on the spraying system and make it to rotate slowly. Thus the spray of sewage is uniformly applied on the top of surface of filter medium. The sewage then trickles over the surface of broken stone and is finally collected by the under drain system.

After continuous working of trickling filter the thickness of bacterial film grows and soon aerobic conditions are set up. Then it is necessary that filtration is stopped, filter medium is washed and cleaned. The trickling filter can be put to use again.

$$\begin{aligned} \text{B.O.D. Load in the primary effluent} &= 174\text{ppm} \\ &= 174 \times 44.50 \times 10^3 / 10^6 \\ &= 7893.684 \text{ kg/m} \end{aligned}$$

Trickling filters are designed on the basis of NRC and Ranking's equation from U.S.A:

(Water supply and Sanitary Engineering :By G.S.Birdie and J.S.Birdie) Circulation ratio : 0.5 - 3.0 (Domestic water) Depth : 0.9 - 2.5

Hydraulic loading $m^3 / m^2 / \text{day}$: 10 - 40 Organic loading : 0.32 - 1.0

Recirculation Ratio : 0.5 - 3.0 (Domestic water)

: upto 8 (Industrial water)

Providing high rate trickling filter with recirculation arrangements using 4 no.s trickling of filter bed 30 m dia and 1.0 m deep

Total volume of filter media $= Xd^2$

$$X30^2 = X \cdot 1.0 \times 4$$

Total volume of filter media = 5026 cu-m

$$= 1.570 \text{ Kgm} / m^2$$

Surface loading = Quantity of sewage / volume of filter media

$$= 45 \times 10^6 / 5026$$

$$= 8953 \text{ ltr} / m^2 / \text{day} \text{ Recirculation ratio} = 2.5$$

Average hydraulic load on filter = 45000

$$\times 2.5 / 1.62$$

$$= 69,444 \text{ cu-m} / \text{day}$$

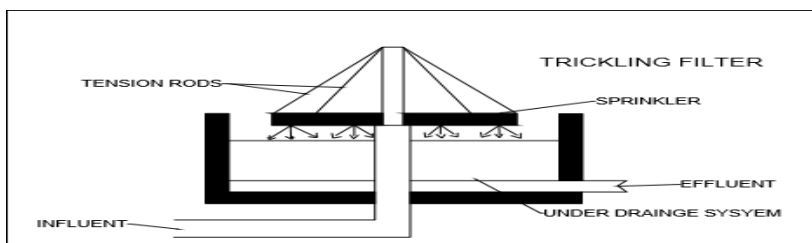

Figure 3.11: Diagram of Trickling filter

DISCUSSION

In the current study, the top eight parameter weights of two selected parameters DO, Temperature, pH, Turbidity, TSS, Chlorides, Hardness, and BOD were used in the decision-making step. We discovered that area Chandandih at the chosen location will be the ideal place for developing a Water Treatment Plant based on the eight WTP characteristics. The water treatment plant emerged as the best plant layout based on the following factors: construction cost, distance from the community, future extension, proximity to an industry, accessibility, disposal facility, transportation, raw water supply, public acceptance and security, and independent source of power.

V. CONCLUSION

Finally, the Suitability Rating for two locations, Chandandih WTP and Nimora WTP, is calculated, revealing that Chandandih is the most ideal location for the building of a water treatment plant, with a suitability index of 0.9.

Dimensions of the each component of waste water treatment plant is worked out. Finally the water treated from this treatment plant can be put to use for purposes like gardens, industrial purposes, washing vehicles and cleaning garages etc..

REFERENCES

1. Alossta, A., Elmansouri, O., & Badi, I. (2021). Resolving a location selection problem by means of an integrated AHP-RAFSI approach. *Reports in Mechanical Engineering*, 2(1), 135–142. <https://doi.org/10.31181/rme200102135a>
2. Ayyildiz, E., & Taskin Gumus, A. (2021). Pythagorean fuzzy AHP based risk assessment methodology for hazardous material transportation: an application in Istanbul. *Environmental Science and Pollution Research*, 28(27), 35798–35810. <https://doi.org/10.1007/s11356-021-13223-y>
3. Bakır, M., & Atalık, Z. (2021). Application of Fuzzy AHP and Fuzzy MARCOS Approach for the Evaluation of E-Service Quality in the Airline Industry. *Decision Making: Applications in Management and Engineering*, 4(1), 127–152. <https://doi.org/10.31181/dmame2104127b>
4. Brown, R. M., McClelland, N. I., Deininger, R. A., & O'Connor, M. F. (1972). A Water Quality Index — Crashing the Psychological Barrier. *Indicators of Environmental Quality*, 173–182. https://doi.org/10.1007/978-1-4684-2856-8_15
5. Choudhury, S., Howladar, P., Majumder, M., & Saha, A. K. (2019). Application of Novel MCDM for Location Selection of Surface Water Treatment Plant. *IEEE Transactions on Engineering Management*, 1–13. <https://doi.org/10.1109/tem.2019.2938907>
6. Choudhury, S., & Saha, A. K. (2017). Prediction of Operation Efficiency of Water Treatment Plant with the Help of Multi-criteria Decision-making. *Water Conservation Science and Engineering*, 3(2), 79–90. <https://doi.org/10.1007/s41101-017-0034-2>
7. Choudhury, S., & Saha, A. K. (2019). Location selection for Installation of Surface Water Treatment Plant by Applying a New Sinusoidal Analytical Hierarchy Process. *International Journal of Energy Optimization and Engineering*, 8(3), 20–42. <https://doi.org/10.4018/ijeoe.2019070102>
8. Choudhury, S., Saha, A. K., & Majumder, M. (2019). Optimal location selection for installation of surface water treatment plant by Gini coefficient-based analytical hierarchy process. *Environment, Development and Sustainability*, 22(5), 4073–4099. <https://doi.org/10.1007/s10668-019-00373-w>