



# INTERNATIONAL JOURNAL OF CREATIVE RESEARCH THOUGHTS (IJCRT)

An International Open Access, Peer-reviewed, Refereed Journal

## Smart Agricultural Monitoring System Using IoT

Mr. Raviraj Bangad  
B.E ( Department of Electrical Engineering)  
KJ's Trinity College of Engineering & Research  
Pune, India

Mrs. Rajashree Chavan  
B.E ( Department of Electrical Engineering)  
KJ's Trinity College of Engineering & Research  
Pune, India

Mr. Prithviraj Jagtap  
B.E ( Department of Electrical Engineering)  
KJ's Trinity College of Engineering & Research  
Pune, India

Mr. Saurabh Jathar  
B.E ( Department of Electrical Engineering)  
KJ's Trinity College of Engineering & Research  
Pune, India line

Prof. R. P. Kelapure  
Assistant Professor, Department of Electrical Engineering  
KJ's Trinity College of Engineering & Research  
Pune, India

**Abstract**— We know that every field increases and changes with technology. The Internet of Things is a turning point for the advancement of technology. The Internet of Things (IoT) has opened the door to the creation of agricultural machines that can complete their tasks. Arduino based systems are very reliable and widely used in agriculture. Smart Farming is powered by Arduino using IoT System. It includes humidity sensor, temperature sensor, soil moisture sensor, PIR sensor and DC motor. The system automatically detects soil moisture and moisture content. The sensor is used to determine the water level, if the water level falls below the limit, the system automatically starts watering. Depending on the temperature change, the sensor does its job. IoT also shows data about humidity, by adding date and time.

**Keywords**— IoT, Arduino Uno, Soil moisture sensor, PIR sensor, Buzzer, DHT 11 (temperature and humidity) sensor, Wi-Fi module, DC to DC converter, Relay, Motor

### I. INTRODUCTION

In this era, innovation is upgrading and it is vital to drift up agribusiness as well. IoT plays a key part in savvy horticulture. Internets of Things (IoT) sensors are utilized to supply essential data around rural areas. Internet of Things (IoT) has opened ways of openings to plan farming frameworks with precision of performing assignments. Arduino based frameworks are solid and can be utilized broadly for horticulture applications. By utilizing IoT framework the savvy horticulture is fueled by Arduino. It incorporates the humidity sensor, temperature sensor, soil moisture sensor, PIR sensor and DC motor. The sensors are utilized to sense the level of water and moisture in the soil, if it is below limit; it starts watering. By monitoring

humidity, temperature sensor does its work. IoT moreover appears the data of temperature, moisture and humidity level by counting date and time. Where IOT plays a really critical part in horticulture, IOT sensors are able of giving data almost of any areas. This IOT based Rural checking framework utilizes remote sensor systems that collects information from distinctive sensor conveyed at different hubs and sends it through the cloud platform. This will help to make agriculture advance and easy.

### II. PROBLEM STATEMENT

The issue emerges at whatever point there is any basic circumstance that cannot be taken care of at that has indicated time. When the climate shifts at that point naturally field parameters moreover suddenly changes. At whatever point there's overwhelming precipitation or temperature changes or may be any mammals are meandering or touching within the field, this may get to be exceptionally difficult to analyze the circumstance and it causes a major problem. Taking this as an issue into thought, planning of IOT based agribusiness observing framework is exceptionally required. This IOT server can be easily monitored from any place and comfortable to get to the changes within the fields. We can screen from anyplace through our portable phone effectively based on the IOT servers and SMS alarms.

### III. BLOCK DIAGRAM

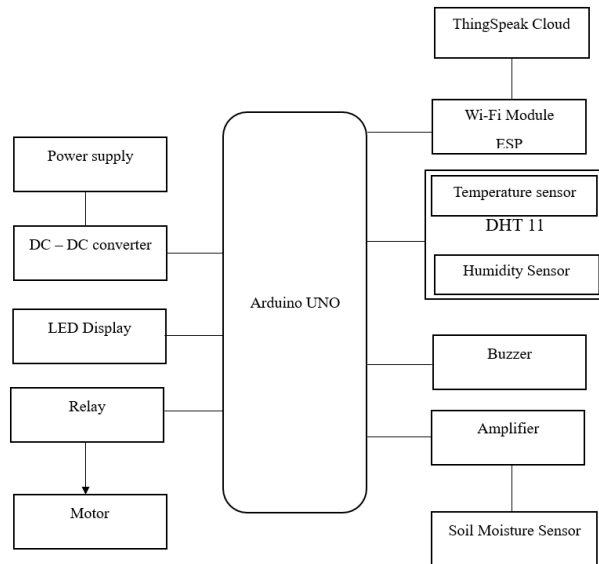

*Fig.a. Block Diagram*

India positioned within the world's five biggest makers of over 80% of rural generation. As expanded request for nourishment due to population and pay growth agricultural advances makes a difference to extend worldwide trim yields up to 67%. To accept the climate, alter on the agribusiness and to extend the generation of feasible field to bolster the planet [1]. The existing strategy and one of the most seasoned ways in farming is the manual strategy of checking the parameters. In this strategy they detect data from manual sensors and monitors it. [2].

It focuses on developing gadgets and device to oversee, show and alert the clients utilizing the points of interest of a wireless sensor network. It points at making agribusiness advance by utilizing robotization and IOT innovations. The highlighting features are GPS based inaccessible controlled robot to perform errand like weeding, spraying, dampness detecting, human and animal detection and keeping watch. [2] The cloud computing gadgets that can make an entire computing framework from sensors to devices that watch information from agribusiness field. It proposes a novel strategy for savvy cultivating by connecting a keen detecting framework and keen irrigator framework through remote communication technology [2].

In the framework employments Arduino is used to control watering and maintenance of the greenhouse [1]. Its employs measurable information obtained from sensors (like temperature, stickiness, dampness and light concentrated sensors) compared with the climate figure for choice making. Kalman filter is utilized to eliminate noise from the sensors. Horticulture Framework (AgriSys) employs temperature, pH, humidity sensors and the hybrid interference to input the information from sensors. [6]

The framework screens the sensors data on LCD and PC. Muhammad (2010), Proposed a straightforward approach to "Automatic Water system control issue utilizing Fake Neural Network Controller". The proposed framework is compared with ON/OFF controller and it is appeared that ON/OFF Controller based Framework comes up short hopelessly because of its limitations. On the other hand, ANN based approach has brought about in conceivable usage of superior and more productive control. These controllers don't require an earlier knowledge of the system and can make it more efficient. [6]

### IV. OBJECTIVE

Design the monitoring system for agriculture applications. Develop the prototype for the system. Observe the performance of the prototype and verify the results. The main objective of this paper is to design a IOT based agriculture monitoring system. This system acts a protector of the fields from various problems.

### V. COMPONENTS USED

#### 1. Arduino UNO-

The maximum length and width of the Uno PCB are 2.7 and 2.1 inches respectively, with the USB connector and power jack extending beyond the former dimension. Three screw holes allow the board to be attached to a surface or case. The Arduino Uno has a resettable poly fused that protects your computer's USB ports from shorts and overcurrent. The Atmega328 has 32 KB of flash memory for storing code. It has also 2 KB of SRAM and 1 KB of EEPROM. If more than 500 mA is applied to the USB port, the fuse will automatically break the connection until the short or overload is removed. ARDUINO UNO is a microcontroller board works with ATmega328p micro controller. It also has ATmega16U microcontroller.



*Fig.b. Arduino UNO*

For Atmega328p It has high performance Atmel Pico power 8bit AVR RISC based microcontroller which is capable of executing powerful instruction in single clock cycle. The board is equipped with set of 14 digital and 6 analog input output pins. It is interfaced to various expansion boards and other peripherals for different applications.

The power supply for the board is given by using mini-USB connection of 5V. It is the one of the best AVR controllers and is used in many ARDUINO boards. The Arduino Integrated Development Environment (IDE) is a cross-platform application in which the functions are written in C and C++ languages. It is used to write and dump the written programs to Arduino compatible boards with the help of third-party cores and other vendor development boards.

#### 2. Thing Speak-

Thing Speak is an IOT analytics platform service that allows you to aggregate, visualize, and analyze live data streams in the cloud. You can send data to Thing Speak from your devices, create instant visualization of live data, and send alerts. One can set up the time to record the data on Thing Speak cloud. This cloud is easily accessible and free

for students. It shows the recorded data of all sensors output (temperature, humidity, soil moisture, buzzer output) in graphical representation and in also table form with date, actual time and accurate readings.

### 3. Soil Moisture sensor-

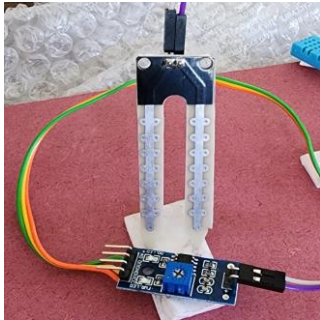

*Fig.c Soil Moisture Sensor*

This sensor can be used to test the moisture of soil, when the soil is having water shortage, the module output is at high level, else the output is at low level. The input for this sensor is 5 V, it is connected to OPAM. By using this sensor one can automatically water the flower plant, or any other plants requiring automatic watering technique (such as by using pump).

The soil moisture sensor uses capacitance to measure the water content of soil. Simply insert the rugged sensor into the soil to be tested, and the volumetric water content of the soil is reported in percent. It measures the dielectric permittivity of the surrounding medium. The sensor creates a voltage proportional to the dielectric permittivity, and therefore the water content of the soil.

### 4. DHT 11-

The humidity sensor manufactured by Honeywell is used for sensing the humidity. It delivers instrumentation quality RH (Relative Humidity) sensing performance in a low cost, solder able SIP (Single In-line Package). Relative humidity is a measure, in percentage, of the vapor in the air compared to the total amount of the vapor that could be held in the air at a given temperature.

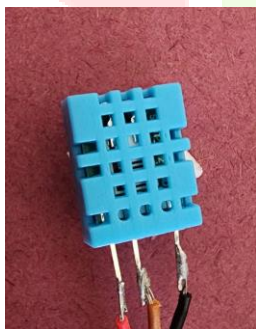

*Fig.d. DHT 11 Sensor*

This DHT11 Temperature & Humidity Sensor features a temperature & humidity sensor complex with a calibrated digital signal output. It ensures high reliability and excellent long-term stability. This sensor includes a resistive-type humidity measurement component and an NTC temperature measurement component, and connects to a high-performance 8-bit microcontroller, offering excellent quality, fast response, anti-interference ability and cost-effectiveness. Its small size, low power consumption and up-to 20-meter signal transmission making it the best choice for various applications, including those most demanding ones.

### 5. PIR Sensor –



*Fig.e. PIR Sensor*

PIR modules have a 3-pin connection at the side or bottom. It's often silkscreened on right next to the connection (at least, ours is!) One pin will be ground, another will be signal and the final one will be power. Power is usually 3-5VDC input. Sometimes larger modules don't have direct output and instead just operate a relay in which case there is ground, power and the two switch connections.

PIR sensors allow you to sense motion, almost always used to detect whether a human has moved in or out of the sensors range. They are small, inexpensive, low-power, easy to use and don't wear out. Connecting PIR sensors to a microcontroller is really simple. The PIR acts as a digital output, it can be high voltage or low voltage, so all you need to do is listen for the pin to flip high (detected) or low (not detected) by listening on a digital input on your Arduino. Power the PIR with 5V and connect ground to ground. Then connect the output to a digital pin. In this example we'll use pin 4. The code is very simple, and is basically just keeps track of whether the input to pin 4 is high or low. It also tracks the state of the pin, so create a sound by using speaker when motion has started and stopped.

### 6. Buzzer –

A buzzer or beeper may be a signaling gadget, more often electronic, regularly utilized in automobiles, family machines such as a microwave broiler, or amusement appear. It most commonly comprises of a number of switches or sensor associated to a control unit that decides on the off chance that and which button was pushed or a show time has passed, and as a rule lights up a light on the fitting button or control board, and sounds a caution within the shape of a nonstop or irregular buzzing or beeping sound.

Initially this gadget was based on an electromechanical framework which was indistinguishable to an electrical chime without the metal gong (which makes the ringing commotion)

### 7. Mini Submersible Pump Motor –

This is a low cost, small size Submersible Pump Motor which can be operated from a 2.5 to 6V power supply. It can take up to 120 litres per hour with very low current consumption of 220mA. Just connect tube pipe to the motor outlet, submerge it in water and power it. Make sure that the water level is always higher than the motor. Dry run may damage the motor due to heating and it will also produce noise.



8. DC – DC buck converter-



**Fig.f. DC-DC buck Converter**

LM2596 DC-DC Buck Converter Adjustable Step Down Power Supply Module Specifications  
 Input Voltage - 3.2V - 40V DC  
 Output Voltage - 1.25V - 35V DC  
 Size - 43mm x 20mm x 15mm  
 Output Current - 2A, Max 3A.

Pin	Name	Detail	Pin	Name	Detail
1	Output	Active high output	4	RX	Receiver
2	+5 V	Power supply	5	TX	Transmitter
3	Ground	Power supply ground	6	Ground	Power supply ground

9. LCD (Liquid Crystal Display)-



**Fig.g. LCD Display**

LCD means liquid crystal. A 16x2 LCD display is very commonly used device, where each character is represented with 5x8 pixel matrix. It operates at 4.7V-5.3V. it consist of 16 pins.

10. ESP Wi-Fi module-

The ESP-01 ESP8266 Serial WIFI Remote Handset Module could be a self-contained SOC with coordinates TCP/IP convention stack that can give any microcontroller get to your WiFi arrange. The ESP8266 is competent of either facilitating an application or offloading all Wi-Fi organizing capacities from another application processor. Each ESP8266 module comes pre-programmed with an AT command set firmware, meaning, you can hook this up to your Arduino gadget and get approximately as much WiFi-ability as a WiFi Shield offers.

The ESP8266 module is a greatly cost-effective board with a gigantic, and ever developing, community. This module encompasses an effective sufficient on board preparing and capacity capability that permits it to be coordinates with the sensors and other application particular gadgets through its GPIOs with minimal improvement up-front and negligible stacking amid runtime. Its high degree of on-chip integration permits for minimal outside circuitry, counting the front-end module, is outlined to possess minimal PCB region.



**Fig.h. ESP Wi-Fi Module**

The ESP8266 supports APSD for VoIP applications and Bluetooth co-existing interfacing, it contains a self-calibrated RF permitting it to work beneath all working conditions and requires no outside RF parts. There is a nearly boundless wellspring of information accessible for the ESP8266, all of which has been given by astonishing community back.

**VI. WORKING**

When the power supply of 12v DC is turned on, firstly supply goes to DC-DC buck converter to convert it from 12v to 5v DC. The input required for almost every component in this system is 5v DC, that's why it is necessary to step down it. When the power supply turns on; soil moisture sensor, temperature sensor, humidity sensor, PIR sensor starts sensing the data and sends it to Arduino. Arduino is a brain of this system, if the feedback signal data from soil moisture sensor and temperature sensor and humidity sensor is less than threshold value it starts acting. If soil moisture is less, it sends the signal to relay which turns the motor on and farm gets watered. If PIR sensor detects an object, it sends data to Arduino which turns on the buzzer. Arduino collects all data from all measuring units and sends it to Thingspeak cloud through Wi-Fi module. Wi-Fi module converts the data in graphical representation and in table form. So, we can observe it from any location all over the world.

VII. RESULT

1.Result for Temperature

The temperature read by DHT 11 sensor is send to Thingspeak cloud, that turned it into graphical form as shown below in Fig.i.

2. Result for Humidity

The humidity measurement done by DHT11 is as shown below in Fig.j.

3.Result for Soil Moisture

The reading sensed by soil moisture is in graphical represented by Thingspeak cloud platform as shown in Fig.k.

4. Result for PIR sensor

The PIR status is as shown in Fig.l. The status given by PIR is either 1 or 0. 1 means an object is detected and at normal

5. The data uploaded on Thingspeak cloud is represented in a table form as shown below.

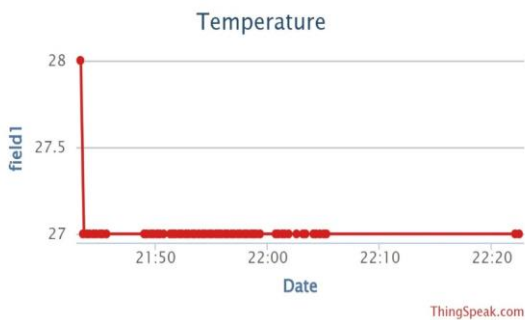

Fig.i. Result for Temperature

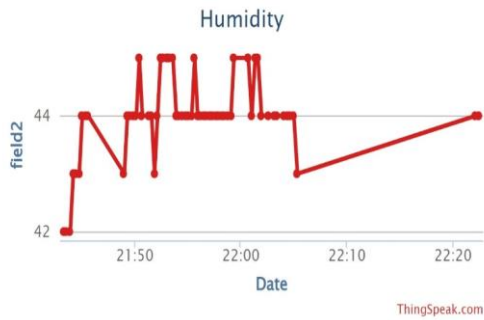

Fig.j. Result for Humidity

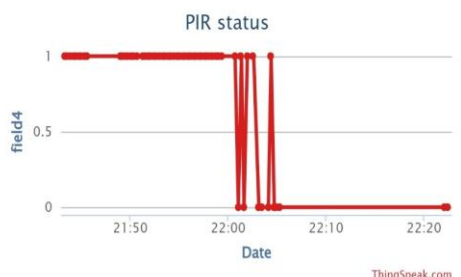
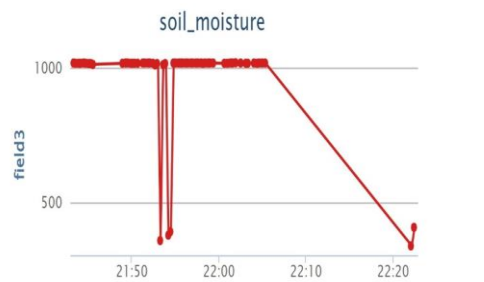

Fig.k. Result for Soil Moisture

Fig. l. Result for PIR Sensor

VIII.CONCLUSION

	A	B	C	D	E	F
1	created_at	entry_id	field1	field2	field3	field4
2	2023-05-10T12:00:20-04:00	1	27	44	1018	1
3	2023-05-10T12:00:37-04:00	2	27	44	1018	1
4	2023-05-10T12:00:54-04:00	3	27	44	1018	1
5	2023-05-10T12:01:12-04:00	4	27	44	1017	1
6	2023-05-10T12:01:29-04:00	5	27	44	1018	1
7	2023-05-10T12:01:46-04:00	6	27	44	1018	1
8	2023-05-10T12:02:03-04:00	7	27	44	1018	1
9	2023-05-10T12:02:20-04:00	8	27	44	1018	1
10	2023-05-10T12:02:37-04:00	9	27	45	1017	1
11	2023-05-10T12:02:54-04:00	10	27	44	1018	1
12	2023-05-10T12:03:11-04:00	11	27	44	1018	1

Smart agricultural monitoring system using IoT made it easy to monitor farms and crops in advance manner. Usage of soil moisture sensor, temperature sensor, humidity sensor and PIR sensor calculated various parameters of the farm. By implementing this system soil moisture, humidity, temperature readings and PIR status is shown and observed in easy manner. This made agriculture more protective and advanced and reduced human efforts. With more research and development in these systems can make it more beneficial and cost cutting with reducing human efforts. This system can help to monitor agricultural data from any corner of the world.

IX. FUTURE SCOPE

In future this system can be improved by adding several modern techniques like irrigation system to the motor, use of solar power source.

By installing a webcam or cameras in the system, photos and videos of the farm can be captured and the data can be sent to database.

Speech based option can be implemented in the system for the people who are less literate. Like Siri and Alexa.

GPS (Global Positioning System) can be installed to provide specific location of the farmer and more accurate weather reports of agriculture field and garden.

Regional language feature can be implemented to make it easy for the farmers who are aware of only their regional language and can use it in any language.

More controlling features like fans, heaters, etc. can be installed and operated.

## X. REFERENCES

- (1) IOT Based Monitoring System in Smart Agriculture, Khandare V.V.<sup>1</sup>, Alande Anuja P.<sup>2</sup>, Alase Anagha A.<sup>2\*</sup>, Patil Anjali M.<sup>2</sup>, Patil Kajal K. <sup>2</sup>Assistant Professor<sup>1</sup>, Student<sup>2</sup>, Department of Electronics and Telecommunication Engineering Department, Sharad Institute of Technology, College of Engineering, Yadrav, Maharashtra, India.
- (2) Iot Based Smart Agriculture Monitoring System  
T. Rajesh<sup>1</sup>, Y. Thrinayana<sup>2</sup>, D. Srinivasulu<sup>3</sup>  
<sup>1,2</sup>Student, Dept. of Electronics & Communication Engineering, SACET, Chirala, Andhra Pradesh, India<sup>3</sup>Associate Professor, Dept. of Electronics & Communication Engineering, SACET, Chirala, Andhra Pradesh, India.
- (3) IOT BASED SMART AGRICULTURAL MONITORING SYSTEM Syeda Fasiha Fatima M. Tech. Student, Department of Electronics and Telecommunication Engineering, Chh. Shahu College of Engineering, Aurangabad, (MS), India – 431 001  
Dr. U. B. Shinde Principal, Department of Electronics and Telecommunication Engineering, Chh. Shahu College of Engineering, Aurangabad, (MS), India – 431 001  
Dr. Sumera Ali Associate Professor, Department of Electronics and Telecommunication Engineering, Chh. Shahu College of Engineering, Aurangabad, (MS), India – 431 001
- (4) IOT based Smart Agriculture Monitoring and Irrigation System  
Swaraj C M PG Student Department of MCA, PES College of Engineering Mandya, Karnataka, India  
K M Sowmyashree Assistant Professor Department of MCA, PES College of Engineering Mandya, Karnataka, India
- (5) IoT based agriculture monitoring system.  
Mr. Bhelave Jayramdas Rajkumar, (Student BE. Dept of computer Engineering P.K. Technical Campus, Pune, India), Mr. Kapse Gaurav Vijay (Student, BE dept. of Computer Engineering P.K. Technical Campus, Pune, India), Mr. Manjare Babaji Baban, (Student BE. Dept of computer Engineering P.K. Technical Campus, Pune, India), Mr. Barne Nilesh Santosh, (Student BE. Dept of computer Engineering P.K. Technical Campus, Pune, India), Prof. S.R. Bhujbal, (assistant prof. Dept. of Comp. Eng. P.K. Technical Campus, Pune, India)
- (6) An IoT based Smart Irrigation System using Soil

Moisture and Weather Prediction

Dr. S. Velmurugan , V.Balaji, T. Manoj Bharathi , K.saravanan ,professor & head, Department of Electronics & Communication Engineering, students, Department of Electronics and communication Engineering, T.J.S. Engineering College, T.S.J Nagar, Kavaraipettai, Chennai – 601206, Tamil Nadu, India.

