



INTERNATIONAL JOURNAL OF CREATIVE RESEARCH THOUGHTS (IJCRT)

An International Open Access, Peer-reviewed, Refereed Journal

Design and Implementation of Power Factor Control using MMC Converter

¹ A. Jacob eraiyanbu, ² S.Vijayabaskar, ³ P. Mariaraja, ⁴ S. Arun

¹PG Student, ²Professor, ³Associate Professor, ⁴Assistant Professor

Department of Electrical and Electronics Engineering

P. A. College of Engineering and Technology, Pollachi, Tamil Nadu, India

Abstract - This paper gives the idea to develop Aiming to address the growth and the integration of renewable sources and electronic loads, different types of dc-dc topologies with specific feature shave been proposed, going from medium frequency isolated Modular Multilevel Converter. This paper presents the theoretical study and simulation validation of a PFC based AC DC using MMC converter applications. This topology is based on the modular multilevel converter (MMC) and employs the concepts of interleaving converters and integrated power stages. A single magnetic element operating at medium frequency is employed to perform galvanic isolation and coupling between the grid-side and load-side converters. The main characteristics of the structure are derived from the aforementioned characteristics, such as passive elements operating with an effective frequency higher than the switching frequency, minimized current ripples at high frequency, as well as reduced volume and weight.

Index Terms -Modular Multi-Level Converter, Switched Capacitor, Power Factor Correction Controller, Half Bridge

I. INTRODUCTION

Intending to reliably interface medium/high voltage dc grids(MVDC/HVDC) and low/medium voltage dc power loads, such as electrical vehicles, electrified transport, data centers, etc, dc-dc converters based on multilevel topologies have been intensively studied in recent years, with the Modular Multilevel Converter (MMC) playing an important role in this scenario, mainly because of the modularity and capability of using well known electronic technologies provided by this topology. In this context, medium frequency isolated MMC based dc-dc topologies have been proposed. The galvanic isolation enhances the fault protection capability and the transformer turns ratio can be used to better interface the inverter and the rectifier stages. Moreover, the medium frequency operation leads to the converter volume/weight reduction. On the other hand, all the power processed by the converter must flow through the transformer and the higher frequency tends to increase the dv/dt applied on the windings, which can limit the medium transformer volume/weight reduction and make its design quite challenging. In order to reduce the power processed by the transformer, the dc auto-transformer converter is proposed. Also based on MMC with Half-Bridge (HB) sub modules (SM), this topology has a direct electrical connection between the inverter and the rectifier stages, allowing part of the power to flow straight from the input dc voltage source to the load and, then, reducing the transformer power rating. However, this arrangement comes

at the cost of loosing the galvanic isolation between the dc terminals, as well as part of the converter fault blocking capability, unless more complex SM configurations are used, instead of HB.

In general, these topologies use either a capacitive path or the MMC arm inductors to perform the voltage balancing between the upper and lower arms. However, when the difference between the input and output voltages is significant, a high ac current and/or bulky arm passive components are needed to achieve this balance, leading to low efficiency and bad use of the components capacity in these cases. This drawback is addressed, where different current source modules are used to intermediate the energy transfer between the dc terminals. Since the increase of the SMs quantity takes to a decrease of the maximum output voltage, these topologies covers applications that demand high voltage ratio between dc input and output.

S. Kenzelmann et.al., (2015) proposed Isolated DC/DC structure based on modular multilevel converter, [1]. Sharon Sanjeev George (2018) Proposed Electric vehicles (EVs) are substantial applications of clean energy. Their effectiveness for mainstream transportation is predicated on the efficient use of stored energy within the vehicle's power pack [2]. Gagandeep Singh, and Shalki Srivastava (2019) proposed a non-isolated high gain DC-DC converter which is preferred for photovoltaic (PV) applications [3]. X. Xiang, et.al., (2018) proposed a compact modular multilevel DC-DC converter for high step-ratio MV and HV use, [4]. N. R. Zargari .et. Al (2017) proposed a transformer less bipolar multistring DC/DC converter based on series-connected

modules, [5].

S. Du and B. Wu, proposed a transformer less bipolar modular multilevel DCDC converter with wide voltage ratios, (2017) [6]. S. H. Kung and G. J. Kish, (2018) proposed a modular multilevel HVDC buck-boost converter derived from its switched-mode counterpart [7]. G. J. Kish, et. al., (2015) proposed a modular multilevel DC/DC converter with fault blocking capability for HVDC interconnects [8]. H. You and X. Cai, (2018) Proposed a three-level modular DC/DC converter applied in high voltage DC grid, [9]. P. Gray et.al., (2022) proposed a modular multilevel DC-DC converter with flying capacitor converter like properties [10]. Rajmadhan et. al., [12] carried out their work for inverter application with few number of switches. Kish et. al., [11] worked for multilevel DC/DC converter with fault blocking capability.

The proposed article describes the a transformer less Power factor corrections based ac-dc converter based the MMC which is composed by four series connected sets of N SMs, here defined as arms (Aa , Ab , Ac and Ad), a flying capacitor (Cf) and an output LC filter composed by Lo and Co . The LC filter input voltage is defined as $v_{LC} = v_{Lo} + v_o$. All the analysis presented in this project considers the topology operating in Buck mode, but can be similarly applied to obtain the Boost mode equations. The SM configuration can be chosen according to some desired features. For example, HB SMs will provide a low account of semiconductors, reducing the converter complexity and losses.

This paper begins with the introduction in Section I. Section II briefs about the block diagram of the prototype system. Section III delivers the elements used in simulation software. In section IV, the results are discussed briefly. Finally it is concluded in the section V.

II. PROTOTYPE BLOCK DIAGRAM

The block diagram of the prototype system gives the idea of implementation of power factor correction because of fluctuation current the functional block diagram and pin connection of the prototype system is shown in Figure. 1.

Intending to reliably interface medium/high voltage dc grids (MVDC/HVDC) and low/medium voltage dc power loads, such as electrical vehicles, electrified transport, data centers, etc, dc-dc converters based on multilevel topologies have been intensively studied in recent years, with the Modular Multilevel Converter (MMC) playing an important role in this scenario, mainly because of the modularity and capability of using well known electronic technologies provided by this topology. In this context, medium frequency isolated MMC based dc-dc topologies have been proposed.

The galvanic isolation enhances the fault protection capability and the transformer turns ratio can be used to better interface the inverter and the rectifier stages. Moreover, the medium frequency operation leads to the converter volume/weight reduction. On the other hand, all the power processed by the converter must flow through the transformer and the higher frequency tends to increase the dv/dt applied on the windings, which can limit the medium transformer volume/weight reduction and make its design quite challenging. In order to reduce the power processed by the transformer, the dc auto-transformer converter is proposed.

Also based on MMC with Half-Bridge (HB) sub-modules (SM), this topology has a direct electrical connection between the inverter and the rectifier stages, allowing part of the power to flow straight from the input dc voltage source to the load and, then, reducing the transformer power rating. However, this arrangement comes at the cost of losing the galvanic isolation between the dc terminals, as well as part of the converter fault blocking capability, unless more complex SM configurations are used, instead of HB. Furthermore, the transformer can still be bulky, specially when the difference between the input and the output voltages is significant. Due to the medium frequency transformer issues, some transformer less MMC based dc-dc converters have been studied.

In general, these topologies use either a capacitive path or the MMC arm inductors to perform the voltage balancing between the upper and lower arms. However, when the difference between the input and output voltages is significant, a high ac current and/or bulky arm passive components are needed to achieve this balance, leading to low efficiency and bad use of the components capacity in these cases. This drawback is addressed, where different current source modules are used to intermediate the energy transfer between the dc terminals. Since the increase of the SMs quantity takes to a decrease of the maximum output voltage, these topologies covers applications that demand high voltage ratio between dc input and output.

Another category of transformer less dc-dc converters is composed by the Switched Capacitor (SC), Switched Inductor (SL) and Hybrid Switched Capacitor (HSC) topologies. The operating principle of these converters consists in parallel/series connecting groups of capacitors/inductors to process the energy, which results in high voltage ratio capability and converters with high power density. Moreover, self-voltage clamping and balancing of some components is achieved on SC and HSC converters. On the other hand, the efficiency dependence on the operating duty cycle, the large components count, the voltage ratio variation with the number of cells and the current/voltage spikes concern can impose some limitations or add complexity to these topologies.

This paper is aimed to present a bidirectional MMC based Hybrid Switched Capacitor (MMC-HSC-DC) dc-dc topology. It is a transformer less converter that structurally differs by the absence of the arms inductors. It provides a new strategy to balance the arms total voltages, which become automatically clamped by the flying capacitor Cf . Consequently, it is not necessary to generate an ac power flux through the arms to achieve the voltage balance, unlike the mentioned topologies. Additionally, the converter acquires a switched capacitor operational behavior.

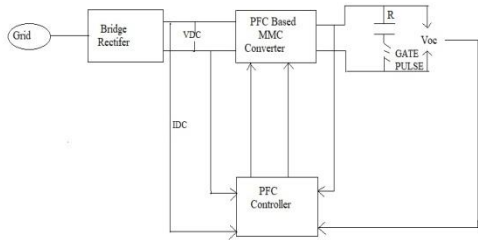

Figure1. Block diagram of the prototype system

Demanding a new approach regarding the topology design, since issues like current spikes and equivalent output resistance must be addressed. On the other hand, when compared to other HSC converters, the number of SMs in the MCC-HSC-DC arms can be changed without leading to output voltage range restrictions. Furthermore, due to the topology operational symmetry, it can be designed to reduce the duty cycle influence on the converter conduction losses. Hence, better efficiency behavior can be achieved in closed-loop operation. The Quasi-Two-Level (Q2L) modulation is used to reduce the passive components size, to create a degree of freedom regarding the dv/dt applied on the magnetic, by limiting the voltage steps on the windings, and to provide a voltage equalization method to balance the SM capacitors within each arm. The step-down unidirectional variant of the proposed converter is introduced, where more superficial and general topology analyses are developed.

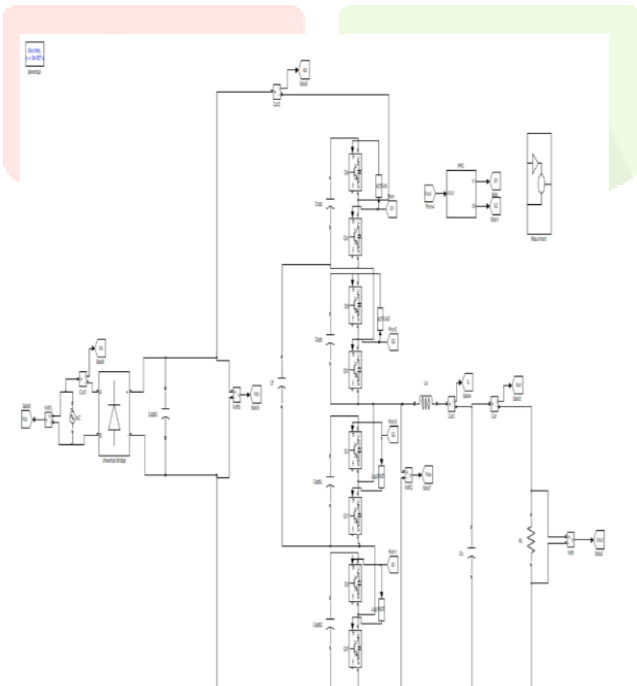

Figure.2 Simulation Diagram of PFC based AC DC using MMC Converter

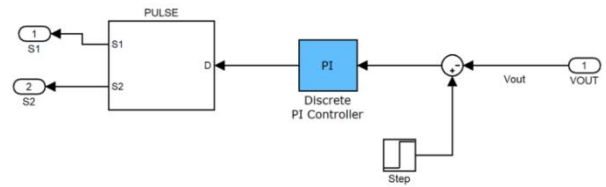

Figure.3 Simulation Diagram of PI controller system

The current paper is conceived to provide a broader and more detailed mathematical approach regarding the topology operation, covering: two operation modes; an equivalent output resistance thorough analysis; a peak current estimation method that takes into account the Q2L transitions and the SM capacitance effects; and experimental results to compare with the analytical data. This text is divided in a general topology overview, approaching the topological states and the applied modulation technique; an average value static analysis, to define the converter equivalent output resistance characteristic and the voltage static gain; an instant value static analysis, to address the SC current spikes; and the laboratory scale prototype experimental results along with discussion. Variables defined with small and capital initial letters represent ac plus dc signals and signal average or RMS value, respectively. Matrices are defined by bold and initial capital letter variables.

III. HARDWARE DESCRIPTION

The elements used to build the proposed prototype are described in this section.

a) MMC Converter A modular multilevel converter (MMC) is an advanced voltage source converter applicable to a wide range of medium and high-voltage applications. It has competitive advantages such as quality output performance, high modularity, simple scalability, and low voltage and current rating demand for the power switches. The generalized configuration of a three-phase MMC is comprised of a DC terminal, an AC terminal, and a converting kernel involving three phase legs. Each leg/phase has two symmetric arms referred to as the upper arm and lower arm. The upper arm and lower arm contain a group of identical sub modules connected in series together with a chock inductor to suppress high-frequency components in the arm current. The research interests of MMCs are primarily associated with the topologies, mathematical modeling, output voltage and current control, sub module balancing control, circulating current control, and modulation methods.



Figure.4 MMC Converter

b) **Power Factor Correction Controller (PFC)** PFC Controller or Power Factor Correction Controller is a front end circuit that is used in AC-DC power supply for improving the power factor and power quality. It is usually used in between the rectifier and the smoothing capacitor of power supply circuits. The PFC controller reduces the harmonic distortion in the supply current and thereby creates an input AC line current waveform in-phase with the sine input voltage waveform. Non-linear loads such as SMPS generates harmonic currents. As a result, the shape of the input AC line current wave changes into a non-sinusoidal and therefore, reduces the power factor. This harmonic distortion in line current degrades power quality. Hence, the PFC controller is used to avoid input current harmonics by minimizing the interference with other devices being powered from the same source. It also improves the power factor significantly to ensure electrical efficiency of the power distribution



Figure.4 Power Factor Correction Controller

c) **Bridge Rectifier**

When four diodes are connected as shown in figure, the circuit is called as bridge rectifier. The input to the circuit is applied to the diagonally opposite corners of the network, and the output is taken from the remaining two corners. Let us assume that the transformer is working properly and there is a positive potential, at point A and a negative potential at point B. the positive potential at point A will forward bias D3 and reverse bias D4. The negative potential at point B will forward bias D1 and reverse D2. At this time D3 and D1 are forward biased and will allow current flow to pass through them; D4 and D2 are reverse biased and will block

current flow. The path for current flow is from point B through D1, up through RL, through D3, through the secondary of the transformer back to point B. this path is indicated by the solid arrows. Waveforms (1) and (2) can be observed across D1 and D3.



Figure.5 Bridge rectifier

One-half cycle later the polarity across the secondary of the transformer reverse, forward biasing D2 and D4 and reverse biasing D1 and D3. Current flow will now be from point A through D4, up through RL, through D2, through the secondary of T1, and back to point A. This path is indicated by the broken arrows. Waveforms (3) and (4) can be observed across D2 and D4. The current flow through RL is always in the same direction. In flowing through RL this current develops a voltage corresponding to that shown waveform (5). Since current flows through the load (RL) during both half cycles of the applied voltage, this bridge rectifier is a full-wave rectifier.

IV. SOFTWARE REQUIREMENTS

For control the power factor, the prototype system involves One HDL code (simulink) and one Mathematical based Algorithm development (MATLAB) which is the package of same software called MATLAB.

a) **Simulink**

Simulink is a MATLAB-based graphical programming environment for modeling, simulating and analyzing multi-domain dynamical systems. Its primary interface is a graphical block diagramming tool and a customizable set of block libraries.

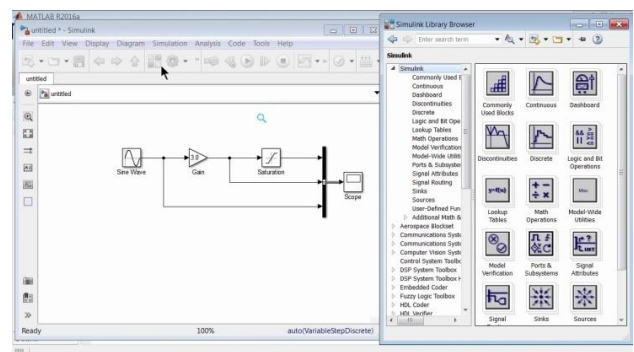

Figure.6 Simulink

b) MATLAB

MATLAB is a programming platform designed specifically for engineers and scientists to analyze and design systems and products that transform our world. The heart of MATLAB is the MATLAB language, a matrix-based language allowing the most natural expression of computational mathematics.

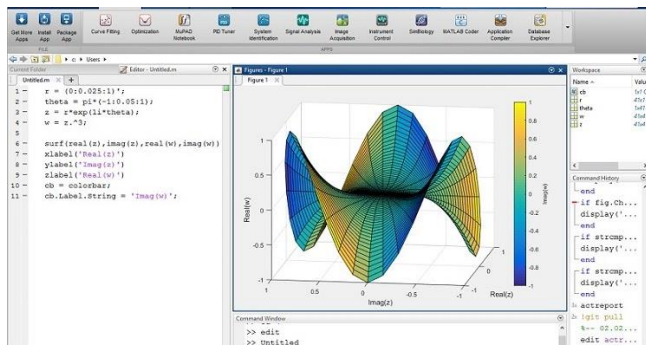

Figure.7 MATLAB

RESULTS

Various aspects of the design and operation are enhanced compared to a full power converter, like a greater efficiency of the AC-DC conversion and a small power rating for the converter is accomplished. In spite of the changes in power sources comparison with an existing converter, proposed system results in lower conversion losses and a higher efficiency and attains better performance compared to the existing ones.

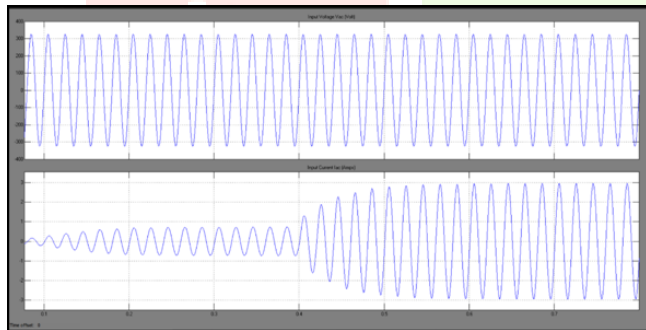

Figure.8 Output Waveform of Input Voltage/Current

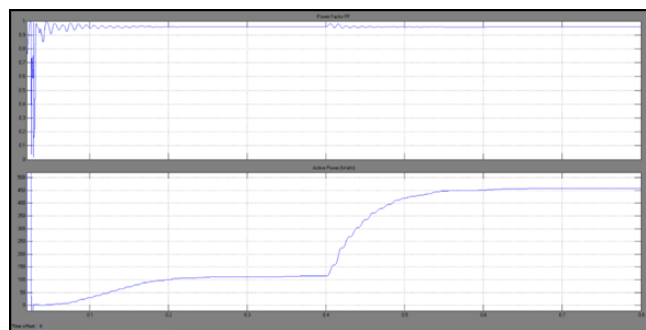

Figure.9 Output Waveform of Power factor/ Active Power

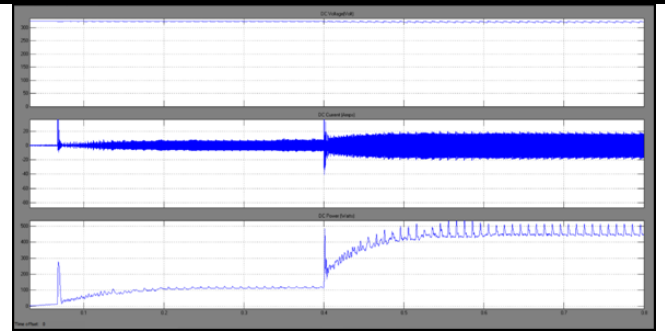

Figure.10 Output Waveform of DC Voltage/Current/Power

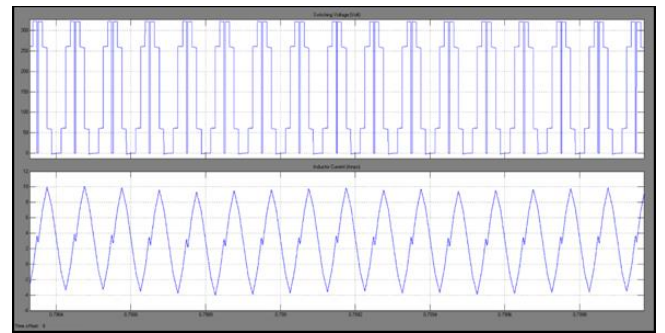

Figure.11 Output Waveform of Switched Voltage/Inductor Current

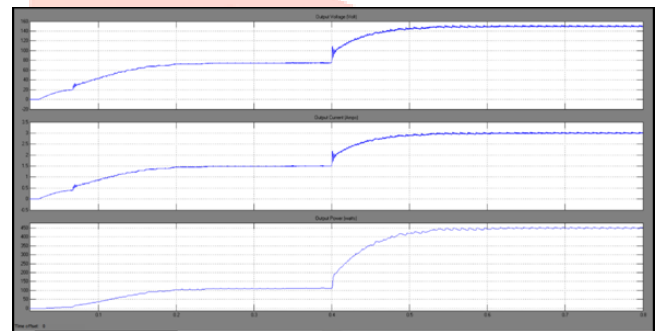

Figure. 12 Output Waveform

It is a measurement of the degree of the utilization of the power from grid. Mathematically it is the proportion of the real power to the apparent power and is in the range of 0 to 1.

$$PF = \frac{\text{Real Power}}{\text{Apparent Power}}$$

Real power is in watts and is the power necessary for real work done. Apparent power is in volt-amp. and is the vector summation of active and reactive power.

For pure sinusoidal voltage and current waveforms; $PF = \cos \phi$

Where $\cos \phi$ is the displacement factor of the voltage and current. In general PFC tends to the compensation of the displacement factor.

Hence in simple, the power factor correction is referred as the minimization of the line current harmonic. The main objective of the thesis is the power factor correction i.e.; maintaining a least phase angle between the input voltage and current with improved THD level i.e. keeping the harmonic content to a minimum level. The

effect of harmonic and its problems on power system is observed as significant and hence Electricity regulatory commissions and utilities, all over the world is penalizing the users for harmonic dumping into the supply lines. Central Electricity Regulatory Commission of India has given guideline to Institute of Electrical and Electronics Engineers (IEEE) Standard 519-92 on permissible limits for harmonics in the electrical system. Both the utility and users should know and understand the standard and the essential of limits specified.

The non-linear loads in the distribution network, line current harmonics are introduced, which need to be minimized. There are numbers of procedures for the power factor correction. But mainly, it categorized into methods as; "Passive method" and "Active method". L-C filter is used in "Passive PFC approach". L-C filter is introduced between the supply line and diode rectifier to improve the shape of the line current. It is simple and rugged technique but bulky in size and expensive. Moreover, in this technique power factor cannot be highly improved and output voltage is not controllable. Active switches are used in association with reactive element for "Active PFC approach" for the improvement of line current shape and to obtain controllable output voltage. For this DC-DC converter is in employment and is working at high frequency to make shape of the line current waveform as sinusoidal. Boost, buck, buck-boost, fly back, cuk, or sepic topologies are the commonly used PFC DC-DC converter topologies. Mainly Boost Converter topology is more suitable for PFC application and is widely used for PFC pre-regulation application.

V. CONCLUSION

A PFC based AC DC using MMC converter topology is proposed. It can be composed by different SM configurations according to the application requirements, and the number of SMs per arm is defined in order to attend the semiconductors blocking voltage limit. The theoretical analysis, design procedures, and simulation results for the proposed topology have been presented and discussed to validate the operation of the proposed topology. In fact, they demonstrate the operation of the proposed converter at high power factor condition. Considering that the losses regarding the passive elements and the semiconductors connected to the secondary side of the converter have been neglected, and attained high efficiency with less voltage stress. The PWM modulation scheme and the average current mode control strategy associated with the additional voltage balance and circulating current control loops demonstrate to be an adequate approach for the proposed converter operation. In addition, the modulation technique provides a higher operating frequency for the magnetic elements, thus leading to reduced weight and volume of the converter.

VI. REFERENCES

- [1] S. Kenzelmann, A. Rufer, D. Dujic, F. Canales, and Y. R. de Novaes, "Isolated DC/DC structure based on modular multilevel converter," *IEEE Trans. Power Electron.*, vol. 30, no. 1, pp. 89–98, Jan. 2015.
- [2] G. Lambert, M. V. Soares, P. Wheeler, M. L. Heldwein, and Y. R. de Novaes, "Current-fed multipulse rectifier approach for unidirectional HVDC and MVDC applications," *IEEE Trans. Power Electron.*, vol. 34, no. 4, pp. 3081–3090, Apr. 2019.
- [3] X. Xiang, X. Zhang, T. Lüth, M. M. C. Merlin, and T. Green, "A compact modular multilevel DC-DC converter for high step-ratio MV and HV use," *IEEE Trans. Ind. Electron.*, vol. 65, no. 9, pp. 7060–7071, Sep. 2018.
- [4] S. Milovanovic and D. Dujic, "High-power DC–DC converter utilizing scott transformer connection," *IET Electric Power Appl.*, vol. 13, no. 10, pp. 1441–1452, Apr. 2019. [Online]. Available: <https://digital-library.theiet.org/content/journals/10.1049/iet-epa.2018.5746>
- [5] A. Schön and M.-M. Bakran, "A new HVDC-DC converter for the efficient connection of HVDC networks," in *Proc. Europe Int. Exhib. Conf. Power Electron. Intell. Motion Renewable Energy Manage. Nürnberg: VDE Verlag GmbH*, 2013, pp. 525–532.
- [6] S. Du, B. Wu, K. Tian, D. Xu, and N. R. Zargari, "A novel medium-voltage modular multilevel DC-DC converter," *IEEE Trans. Ind. Electron.*, vol. 63, no. 12, pp. 7939–7949, Dec. 2016.
- [7] S. Du, B. Wu, D. Xu, and N. R. Zargari, "A transformerless bipolar multistring DC/DC converter based on series-connected modules," *IEEE Trans. Power Electron.*, vol. 32, no. 2, pp. 1006–1017, Feb. 2017.
- [8] S. Du and B. Wu, "A transformerless bipolar modular multilevel DCDC converter with wide voltage ratios," *IEEE Trans. Power Electron.* vol. 32, no. 11, pp. 8312–8321, Nov. 2017.
- [9] S. Du, B. Wu, and N. R. Zargari, "A transformerless high-voltage DC–DC converter for DC grid interconnection," *IEEE Trans. Power Del.*, vol. 33, no. 1, pp. 282–290, Feb. 2018.
- [10] S. H. Kung and G. J. Kish, "A modular multilevel HVDC buck-boost converter derived from its switched-mode counterpart," *IEEE Trans. Power Del.*, vol. 33, no. 1, pp. 82–92, Feb. 2018.
- [11] G. J. Kish, M. Ranjram, and P. W. Lehn, "A modular multilevel DC/DC converter with fault blocking capability for HVDC interconnects," *IEEE Trans. Power Electron.*
- [12] D. Rajmadhan, A. Kuppaswamy, P. Mariaraja, "Three Phase 11-Level Single Switch Cascaded Multilevel Inverter, *The International Journal of Engineering and Science*, Vol.3, No.3, pp: 19-25, 2014.