



COMPARATIVE PERFORMANCE ANALYSIS OF FIVE LEVEL CHB AND MMC USING PHASE DISPOSITION CARRIER PWM

¹P. Uma Ashitha, ²Raja Babu

¹PG student, ²Assistant Professor,
¹EEE Department,

¹Dr. K V Subba Reddy Institute of Technology, Kurnool, India

Abstract: This paper presents the Phase Disposition (PD) Carrier based Pulse Width Modulation (PWM) for five-level Modular Multilevel Converter (MMC). The projected control scheme is implemented for both Cascade H-Bridge (CHB) and MMC. The CHB converter is required individual dc source and leads complexity. The CHB is not suitable for the PV applications due to requirement of individual dc sources. Recently, MMC are popular in converter topologies. The MMC is projected in this paper to overcome above demerits. The MMC is controlled using PD PWM. The performance of MMC is compared with CHB using PD PWM. The performance parameter of Total Harmonic distortion (THD) is presented in this paper.

Index Terms - CHB, MMC, PWM, PDPWM, THD.

I. INTRODUCTION

Through a series-parallel combination of the semiconductor switches, multilevel inverters (MLIs) are able to increase the voltage levels by a factor of (n minus 1) in comparison to that of conventional high-power two-level voltage source inverters (VSIs), where n represents the number of output voltage levels [1]. Harmonic distortions, dv/dt stress on the semiconductor switches, and EMI at the output voltage are all reduced in an MLI compared to a traditional inverter of the same power rating [2]. There is a wide variety of uses for MLIs, including low-voltage and low-power applications [3], medium-voltage and high-power applications [4]-[5], solar grid-connected systems [6], [7], locomotive traction [8], and others [9]. Neutral point clamped (NPC) [10], flying capacitor (FC) [11], and cascaded H-bridge (CHB) [13]-[26] are the three main types of topologies used in these MLIs. Since more diodes and capacitors are used in the NPC topology to provide larger output voltage levels, a sophisticated control mechanism is required [25]. Although the amount of components in an FC topology inverter is equivalent to that of an NPC inverter, the larger number of capacitors needed results in a larger overall circuit. The CHB inverter, on the other hand, is made up of discrete low-voltage H-bridge modules that are wired to independent dc sources in order to generate a wide range of output voltage levels (n). The PWM gate pulses in the standard carrier-based PWM method are generated from a combination of a triangular carrier wave and a reference sinusoidal wave. While traditional PWM is the most straightforward method of PWM pulse generation for industrial driving applications, it also produces low-frequency harmonics at greater modulation index (MI) and switching frequencies. A common method for regulating the AC voltage produced by CHB dc/ac converters is multicarrier pulse width modulation (MCPWM). To generate a low-frequency output voltage, MCPWM employs (n-1) triangular waves with a varying duty cycle at a high frequency.

II. MODULAR MULTILEVEL CONVERTER

One of the potential topologies in the multi-cell converter family is known as the modular multilevel converter or MMC for short. Because of the MMC, there is no longer a requirement for isolated DC sources or a transformer when conducting high-voltage operations. In order to achieve the appropriate amount of system voltage while simultaneously generating a high-quality, multilevel output voltage waveform, it makes use of a cascade connection of sub-modules. Using IGBT devices and DC capacitors allows for the sub module, which is a building element that makes up the MMC, to be designed in a variety of different shapes. The application, operating voltage, and rating of the IGBT devices all play a role in determining the optimal number of sub modules for usage in the MMC. There is hope in the form of the modular multilevel converter (MMC) topology for industrial uses of both high voltage and high power. A chopper cell is another name for the half-bridge (HB) sub module. Fig. 1 depicts the circuit configuration of a half-bridge sub module.

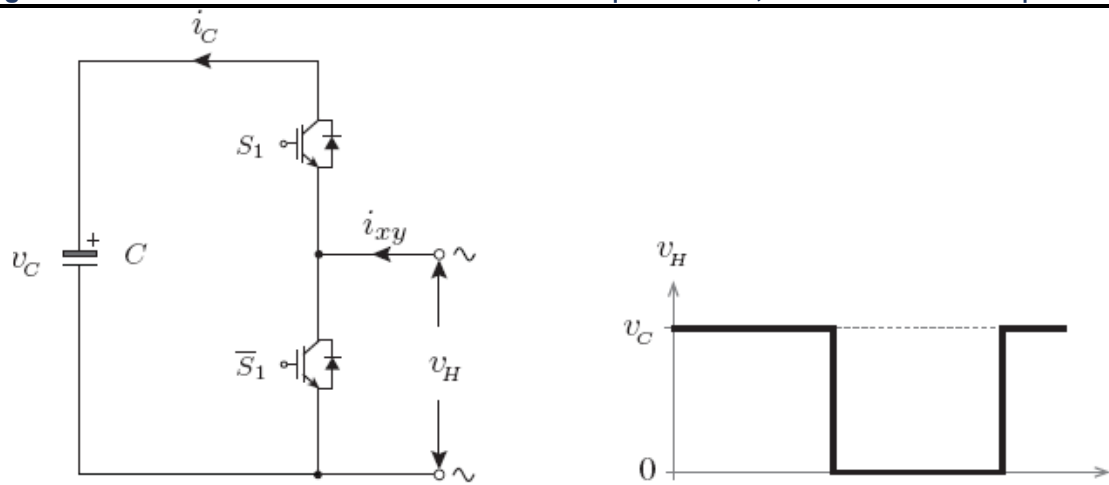

Fig. 1: Half-bridge sub module and output voltage waveform

DC capacitor current is either equal to the AC current or zero, depending on the position of the top switch S_1 . Table 1 displays the various states that S_1 can be in, together with the resulting DC capacitor voltage for various AC current directions. The configuration of MMC is shown in Fig.2.

Table 1: Switching states of HB SM

| State | S_1 | v_H |
|-------|-------|-------|
| 2 | 1 | v_c |
| 1 | 0 | 0 |

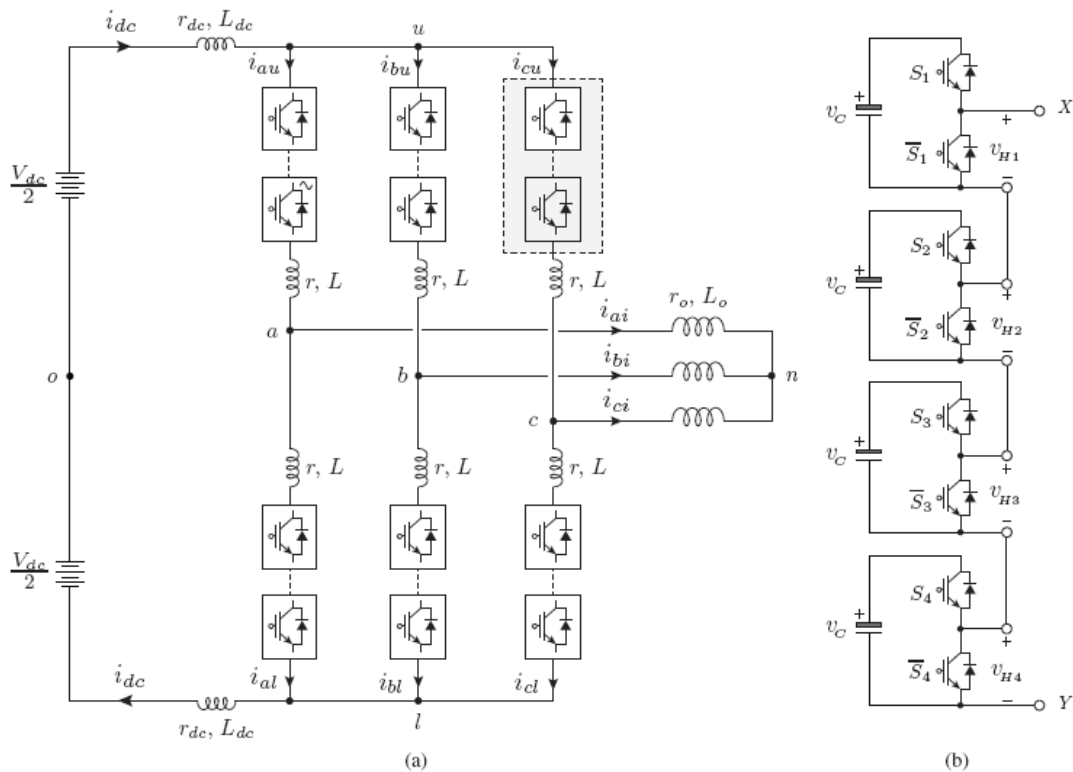

Fig.2: Modular multilevel converter and arm configuration: (a) MMC with passive load and (b) connection diagram of HB sub module with in the arm

The arm voltage equation, which represents the operation of an arm, is given by

$$v_{XY} = v_{H1} + v_{H2} + v_{H3} + v_{H4} \tag{1}$$

Or

$$v_{XY} = S_1 v_c + S_2 v_c + S_3 v_c + S_4 v_c \tag{2}$$

The arm voltage is the same as the sum of the voltages that are output from the sub modules. Each sub module's output voltage is proportional to the product of the voltage of the associated sub module's capacitor and the switching state of that sub module. The aforementioned principle is easily adaptable to accommodate an unlimited number of sub modules per arm. The multilevel voltage waveform that is produced by a modular multilevel converter is controlled to be produced across the AC system by the sub-modules that are located in the upper and lower arms of the converter.

III. PHASE DISPOSITION PWM

When it comes to managing the ac output of power electronic converters, the pulse-width-modulation (PWM) technique is one of the most common strategies used. With this method, the intended average low-frequency output voltage or current can be achieved by varying the duty cycle of the converter switches at a high frequency. This can be done to produce the desired result. Since the early 1980s, modulation theory has been one of the most important research focuses in the field of power electronics, and it continues to garner a significant amount of attention and interest currently. In concept, the goal of all modulation methods is to generate trains of switching pulses that, at any given time, have the same fundamental volt-second average as a target reference waveform. The pulse width modulation (PWM) schemes for a multilevel inverter can be decomposed into high switching frequency, low switching frequency, and fundamental switching frequency modulation schemes. These categories are determined by the switching frequency. In this paper PD PWM is considered for both the cascaded five-level inverter and MMC with R-load. The PD PWM method uses carriers that are identical in frequency, amplitude, and phases; the only difference between them is in their DC offset, which allows them to occupy contiguous bands. All of the bands have carriers that are in phase with one another. When using this method, a substantial amount of harmonic energy is focused at the carrier frequency; however, due to the fact that it is a co-phasal component, it is not reflected in the line-to-line voltage. The generation of gate pulses using triangular carrier is shown in Fig.3.

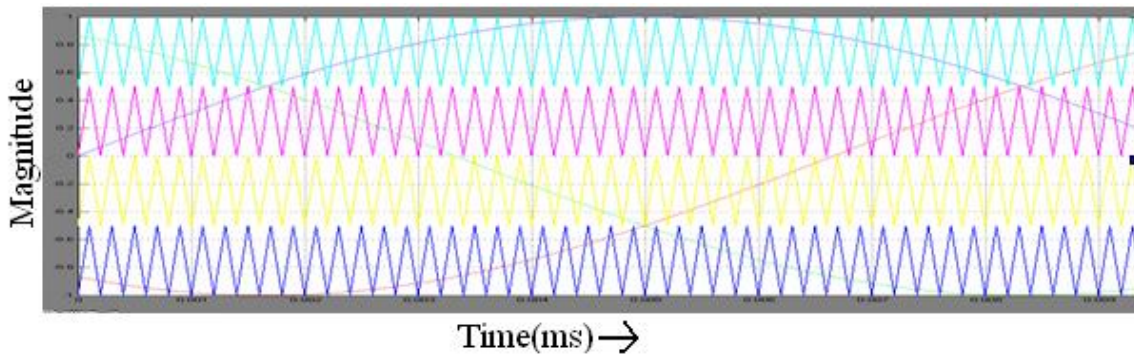
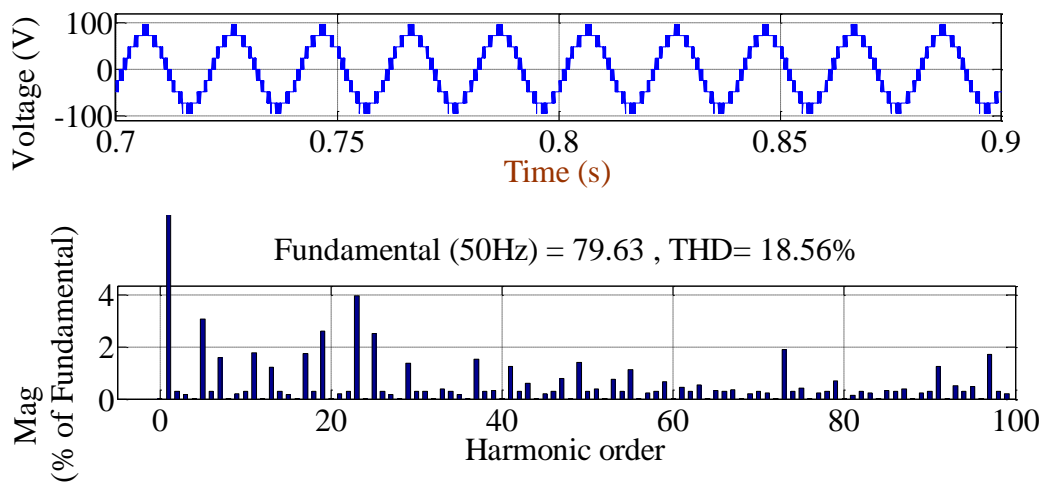

Fig. 3: Generation of gate pulses with triangular carriers

IV. RESULTS AND DISCUSSION

The simulation is done for different modulation indices such as unity, 0.9 and 0.8. The corresponding results are shown in Fig.4, Fig.5 and Fig.6 respectively. It is observed from Fig.4 is the output voltage magnitude of CHB 5L is 79.63 V with 18.56% whereas for MMC 5L, it is 79.53 V with 18.43%. The configuration is further simulated for Modulation Index (MI) = 0.9 and the corresponding results are presented in Fig.7. From this Figure, it is observed that the performance of both the inverters is same but slight improvement in voltage magnitude is observed for MMC 5L.

The simulation results using modulation index of 0.8 is presented in Fig.8. From this, it is observed that the magnitude of voltage is found same and slight improvement in %THD is observed for MMC 5L. The complete comparative performance analysis is presented in Table 2. The output current waveform of 5L CHB and 5L MMC is illustrated in Fig. 5 and Fig.6.



(a) CHB 5L inverter

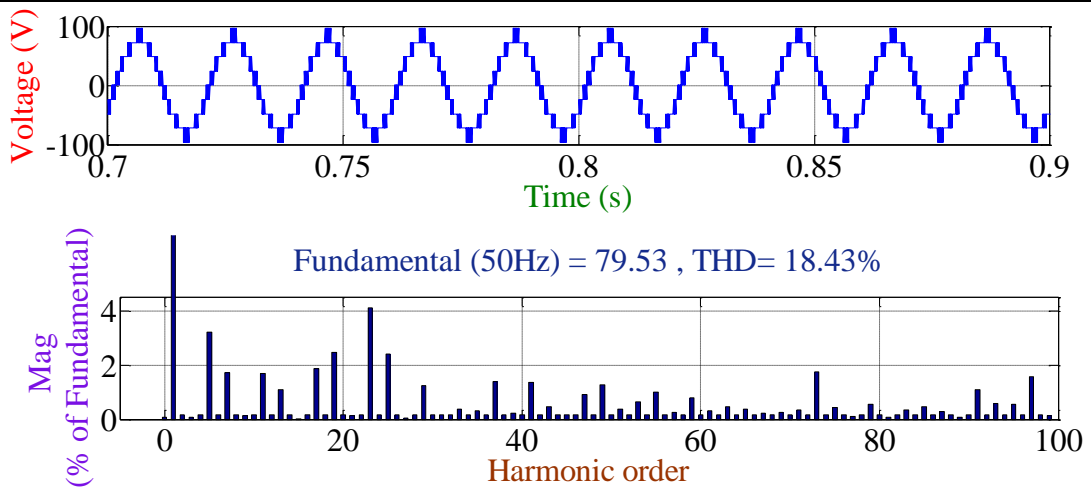

(b) MMC 5L inverter
Fig.4: Performance comparison using Modulation Index of 1

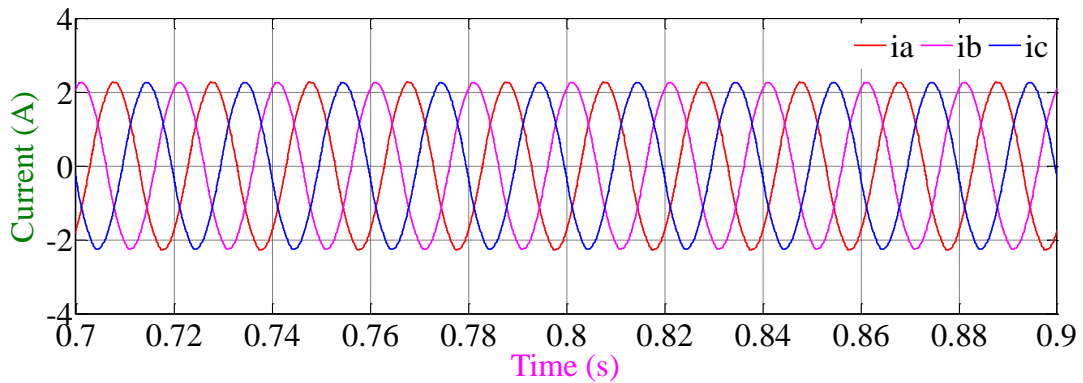

Fig.5: Output current of CHB 5L for Modulation Index of 1

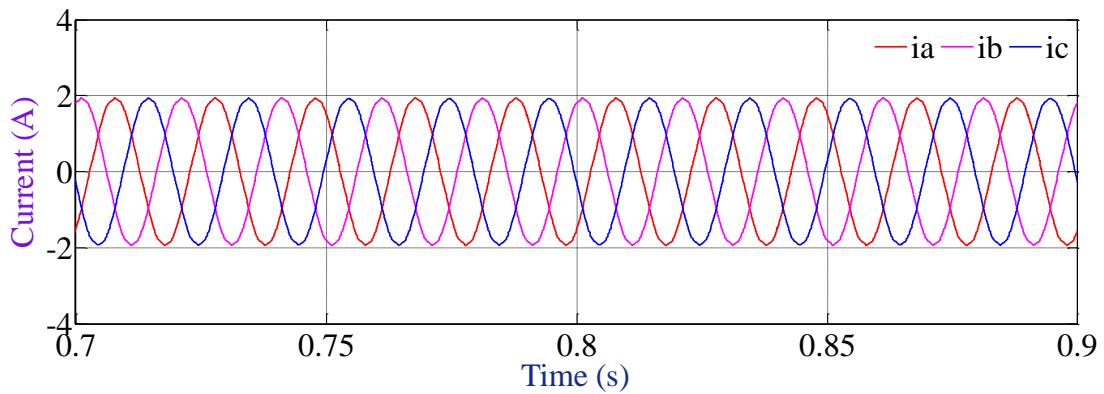
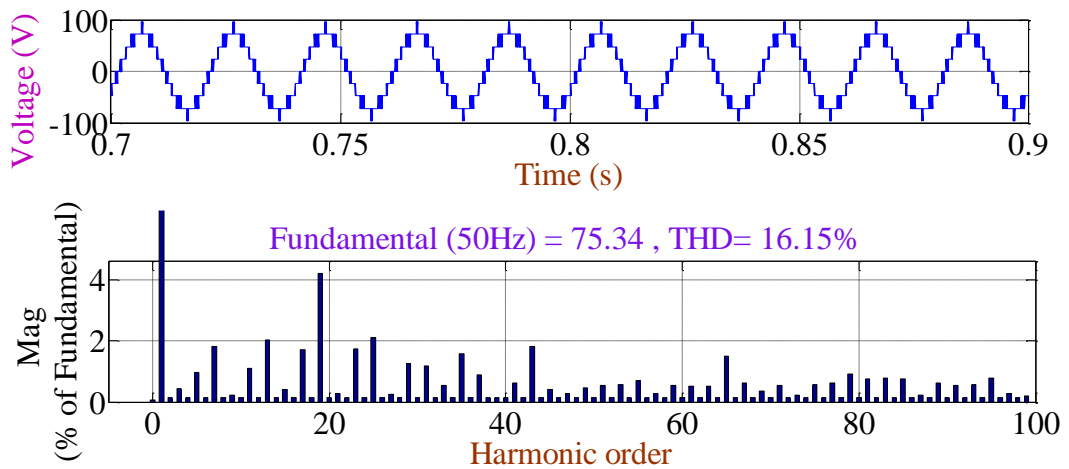

Fig.6: Output current of MMC 5L for Modulation Index of 1



(a) CHB 5L inverter

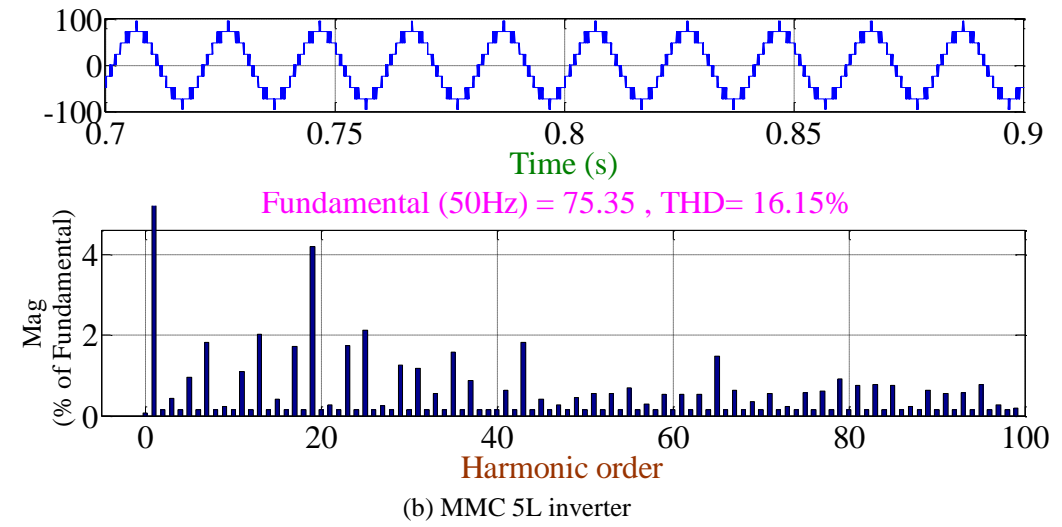

Fig.7: Performance comparison using Modulation Index of 0.9

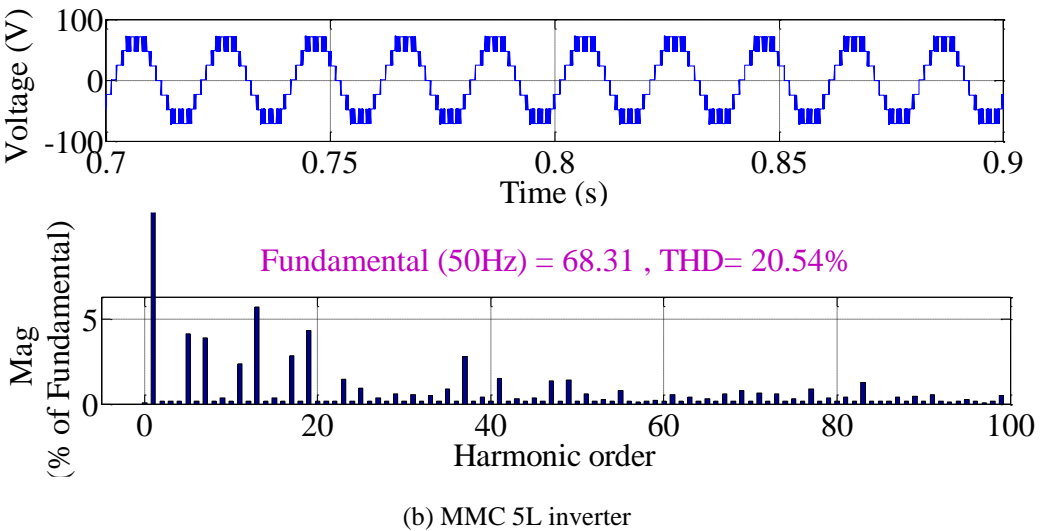
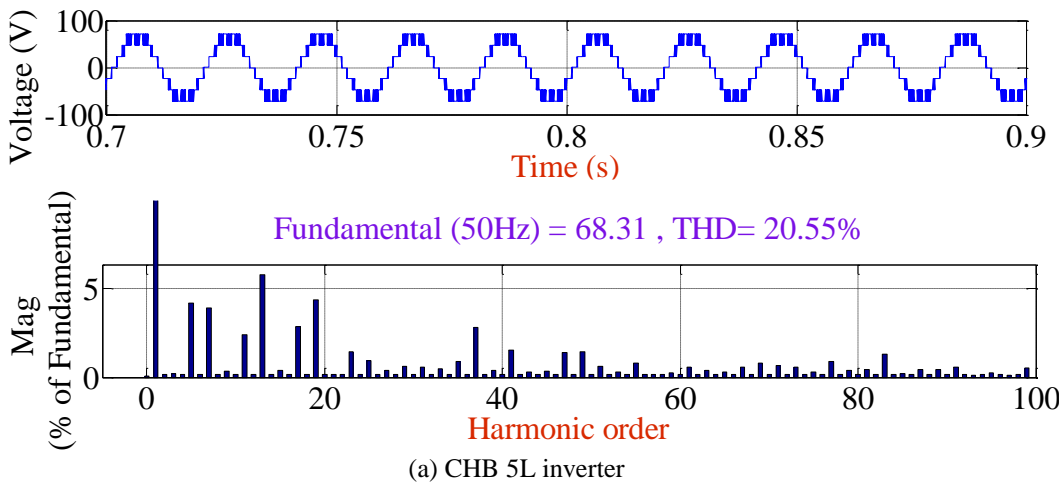

Fig.8: Performance comparison using Modulation Index of 0.8

Table 2: %THD comparison of voltage

| Modulation index | 5L CHB | | 5L MMC | |
|------------------|-------------|-------|-------------|-------|
| | Voltage (V) | %THD | Voltage (V) | %THD |
| M=1 | 79.63 | 18.56 | 79.53 | 18.43 |
| M=0.9 | 75.34 | 16.15 | 75.35 | 16.15 |
| M=0.8 | 68.31 | 20.55 | 68.31 | 20.54 |

V. CONCLUSION

In this work, an MCPWM technique was described that uses a new harmonic mitigation algorithm to determine the range of switching angles for a five-level CHB-MLI that produces the lowest amplitude for the low-frequency harmonics. To be more specific, the method that was proposed was successful in reducing the amplitude of the fifth, seventh, and eleventh order harmonics to less than 5% by adjusting the fundamental amplitude between 0% and 10%. In addition, the method was able to figure out the switching angles of the MCPWM pulses by basing its calculations on the MI as well as the switching frequency of the semiconductor switches.

REFERENCES

- [1]. X. Wu, C. Xiong, S. Yang, H. Yang, and X. Feng, "A simplified space vector pulse width modulation scheme for three-phase cascaded H-Bridge inverters," *IEEE Trans. Power Electron.*, vol. 35, no. 4, pp. 4192–4204, Apr. 2020.
- [2]. I. Abari, A. Lahouar, M. Hamouda, J. B. H. Slama, and K. Al-Haddad, "Fault detection methods for three-level NPC inverter based on DC-Bus electromagnetic signatures," *IEEE Trans. Ind. Electron.*, vol. 65, no. 7, pp. 5224–5236, Jul. 2018.
- [3]. S. Mukherjee, S. K. Giri, and S. Banerjee, "An improved adjustable modulation strategy for three-level NPC inverters considering dynamic loading applications," *IEEE Trans. Ind. Appl.*, vol. 55, no. 4, pp. 3915–3925, Jul./Aug. 2019.
- [4]. N. D. Dao and D. Lee, "Operation and control scheme of a five-level hybrid inverter for medium-voltage motor drives," *IEEE Trans. Power Electron.*, vol. 33, no. 12, pp. 10178–10187, Dec. 2018.
- [5]. Z. Ni, A. H. Abuelnaga, and M. Narimani, "A new fault-tolerant technique based on nonsymmetrical selective harmonic elimination for cascaded H-Bridge motor drives," *IEEE Trans. Ind. Electron.*, vol. 68, no. 6, pp. 4610–4622, Jun. 2021.
- [6]. S. A. Singh, G. Carli, N. A. Azeem, and S. S. Williamson, "Modeling, design, control, and implementation of a modified Z-Source integrated PV/Grid/EV DC charger/inverter," *IEEE Trans. Ind. Electron.*, vol. 65, no. 6, pp. 5213–5220, Jun. 2018.
- [7]. K. Wang, R. Zhu, C. Wei, F. Liu, X. Wu, and M. Liserre, "Cascaded multilevel converter topology for large-scale photovoltaic system with balanced operation," *IEEE Trans. Ind. Electron.*, vol. 66, no. 10, pp. 7694–7705, Oct. 2019.
- [8]. A. Kersten, O. Theliander, E. A. Grunditz, T. Thiringer, and M. Bongiorno, "Battery loss and stress mitigation in a cascaded H-Bridge multilevel inverter for vehicle traction applications by filter capacitors," *IEEE Trans. Transport. Electric.*, vol. 5, no. 3, pp. 659–671, Sep. 2019.
- [9]. F. P. Feletto, R. A. Durham, E. d. C. Bortoni, and J. G. de Carvalho Costa, "Improvement of MV cascaded H-Bridge inverter (CHBI) VFD availability for high-power ESP oil wells," *IEEE Trans. Ind. Appl.*, vol. 55, no. 1, pp. 1006–1011, Jan./Feb. 2019.
- [10]. M. Sharifzadeh, G. Chouinard, and K. Al-Haddad, "Compatible selective harmonic elimination for three-phase four-wire NPC inverter with DC-Link capacitor voltage balancing," *IEEE Trans. Ind. Informat.*, to be published. doi: 10.1109/TII.2019.2934467.
- [11]. C. Sadanala, S. Pattnaik, and V. P. Singh, "A flying capacitor based multilevel inverter architecture with symmetrical and asymmetrical configurations," *IEEE J. Emerg. Sel. Topics Power Electron.*, to be published. doi:10.1109/JESTPE.2020.3029681.
- [12]. C. B. Barth et al., "Design and control of a gan-based, 13-Level, flying capacitor multilevel inverter," *IEEE J. Emerg. Sel. Top. Power Electron.*, vol. 8, no. 3, pp. 2179–2191, Sep. 2020.
- [13]. F. A. d. C. Bahia, C. B. Jacobina, N. Rocha, I. R. F. M. P. da Silva, and R. P. R. de Sousa, "Hybrid asymmetric cascaded multilevel inverters based on Three- and Nine-Level H-Bridges," *IEEE Trans. Ind. Appl.*, vol. 55, no. 6, pp. 6047–6060, Nov./Dec. 2019.
- [14]. T. Qanbari and B. Tousei, "Single-Source three-phase multilevel inverter assembled by three-phase two-level inverter and two single-phase cascaded H-Bridge inverters," *IEEE Trans. Power Electron.*, vol. 36, no. 5, pp. 5204–5212, May 2021.
- [15]. X. Wu, C. Xiong, S. Yang, H. Yang, and X. Feng, "A simplified space vector pulsewidth modulation scheme for three-phase cascaded H-Bridge inverters," *IEEE Trans. Power Electron.*, vol. 35, no. 4, pp. 4192–4204, Apr. 2020.
- [16]. J. S. Mohamed Ali and V. Krishnasamy, "Compact switched capacitor multilevel inverter (CSCMLI) with self-voltage balancing and boosting ability," *IEEE Trans. Power Electron.*, vol. 34, no. 5, pp. 4009–4013, May 2019.
- [17]. Q. Huang and A. Q. Huang, "Feed forward proportional carrier-based PWM for cascaded H-Bridge PV inverter," *IEEE J. Emerg. Sel. Top. Power Electron.*, vol. 6, no. 4, pp. 2192–2205, Dec. 2018.
- [18]. H. Lin, et al., "A simplified 3-D NLM-Based SVPWM technique with voltage-balancing capability for 3LNPC cascaded multilevel converter," *IEEE Trans. Power Electron.*, vol. 35, no. 4, pp. 3506–3518, Apr. 2020.
- [19]. A. Routray, R. K. Singh, and R. Mahanty, "Harmonic minimization in three-phase hybrid cascaded multilevel inverter using modified particle swarm optimization," *IEEE Trans. Ind. Informat.*, vol. 15, no. 8, pp. 4407–4417, Aug. 2019.
- [20]. A. Perez-Basante, et al., "Circulating current control for modular multilevel converters with (N+1) selective harmonic Elimination—PWM," *IEEE Trans. Power Electron.*, vol. 35, no. 8, pp. 8712–8725, Aug. 2020.
- [21]. C. Buccella, M. G. Cimatorini, M. Tinari, and C. Cecati, "A new pulse active width modulation for multilevel converters," *IEEE Trans. Power Electron.*, vol. 34, no. 8, pp. 7221–7229, Aug. 2019.
- [22]. S. K. Sahoo and T. Bhattacharya, "Phase-shifted carrier-based synchronized sinusoidal PWM techniques for a cascaded H-Bridge multilevel inverter," *IEEE Trans. Power Electron.*, vol. 33, no. 1, pp. 513–524, Jan. 2018.
- [23]. K. Yang, Z. Yuan, R. Yuan, W. Yu, J. Yuan, and J. Wang, "A groebner bases theory-based method for selective harmonic elimination," *IEEE Trans. Power Electron.*, vol. 30, no. 12, pp. 6581–6592, Dec. 2015.
- [24]. G. Schettino, F. Viola, A. O. Di Tommaso, P. Livreri, and R. Miceli, "Experimental validation of a novel method for harmonic mitigation for a three-phase five-level cascaded H-Bridges inverter," *IEEE Trans. Ind. Appl.*, vol. 55, no. 6, pp. 6089–6101, Nov./Dec. 2019.
- [25]. M. Sharifzadeh, H. Vahedi, R. Portillo, L. G. Franquelo, and K. Al-Haddad, "Selective harmonic mitigation based self-elimination of triplen harmonics for single-phase five-level inverters," *IEEE Trans. Power Electron.*, vol. 34, no. 1, pp. 86–96, Jan. 2019.
- [26]. Z. Gao and Q. Lu, "A hybrid cascaded multilevel converter based on Three-level cells for battery energy management applied in electric vehicles," *IEEE Trans. Power Electron.*, vol. 34, no. 8, pp. 7326–7349, Aug. 2019.