



# INTERNATIONAL JOURNAL OF CREATIVE RESEARCH THOUGHTS (IJCRT)

An International Open Access, Peer-reviewed, Refereed Journal

## Line Follower Stretcher

K chanikya Reddy, D Anusha, B Rohith Varma, D Vamshi, K Varun Kumar

*Department of Electronics and Communication Engineering,  
Sreenidhi Institute of Science and Technology, Hyderabad*

### Abstract

In this period, there are increasing needs for automation and Industry 4.0. Automation is necessary for every machine since it helps to boost productivity and efficiency. A stretcher that is mechanised is created with these demands in mind. The machine or device in the manufacturing sector finds its way to move from one location to another. The autonomous guided vehicle has the ability to stick to a predetermined path. The use of automation improves and maintains quality while reducing human mistake in handling and increasing job efficiency, all of which contribute to economic growth. An automated stretcher that responds to commands has been created. Multispecialty hospitals with huge buildings can benefit from this use.

The name of this machine is "Line Follower Stretcher." Using Ir sensors, the proposed system detects the dark path and moves in that direction on the ground. This technique reduces the need for labour while also making work easier. According to the specifications, a black line is traced through the hospital, and the stretcher recognises the lines and travels there on its own. The line-following robot is powered by an Arduino-based system. If there is a problem, a buzzer sounds to signal the moving impediment to move out of the way.

**Keywords:** Ir sensor, Arduino, Stretcher, Line follower.

### Introduction

Robots are now essential for use in many industries due to the scientific advancements occurring in this world today, but their use is not only restricted to the industrial sector; it has also spread to other industries such as those in restaurants, laboratories, hospitals, and educational settings due to the robots' high degree of accuracy and ability to significantly reduce human interference and error. Of course, the most recent period has seen an increase in the use of robots. Utilizing the security can lower the project owner's running expenses. In order to accomplish this, a robot that Utilizing the security can lower the project owner's running expenses. And the way to do it is to build a robot that can precisely and fully reproduce two or three people. These robots are not impacted by human emotions or the effects of fatigue or exhaustion. Our nation's population is growing quickly, and with more people comes the need for effective service management. A place like a hospital needs surveillance around-the-clock. Insufficient staff members and careless nurses pose a serious risk to patients' lives. Of course, the easy but ineffective response to this is to hire more employees. The age of technology and automation is now. Automation will be much more productive if it is implemented in healthcare facilities. The use of line-following robots can bring automation to medical facilities. In the event of an emergency, a line-following robot can serve as a temporary nurse and help the hospital staff. Additionally, a robot of this type will serve as a delivery robot in operating rooms where doctors Additionally, this type of robot will serve as a delivery robot in operating rooms when surgeons may require additional supplies in an emergency. This type of robot has benefits including quick service, availability around-the-clock, more dependability, and greater efficiency.

Three laws: Planck's radiation law, Stephan Boltzmann law, and the operation of IR sensors. This robot kind is the one that will follow a user-indicated white or black path.

## STRETCHER TYPES:

1. **Portable stretcher:** A flat stretcher or folding stretcher are other names for this kind of stretcher. It is substantially lighter than a typical wheeled stretcher, which makes it much simpler to move a patient downstairs or out of confined locations.
2. **Simple stretchers:** are the most simple kind. They are made of canvas or another synthetic material suspended between two poles or tubular aluminium frames, making them lightweight and portable. Many are kept in storage as emergency supplies and are frequently surplus military equipment.
3. **Flexible stretcher:** The folding stretcher, also known as a top deck or collapsible stretcher, is composed of rubberized canvas or another flexible material, like thick plastic, and frequently has wooden slats sewed into pockets.
4. **Stair chair:** The stair chair makes it easier for rescuers to carry seated medical patients through narrow passageways and down stairs where a regular stretcher cannot. Folding chairs with an aluminium frame and a cloth seat and back; the majority have rubber wheels at the back. The more recent brands are composed of strong folding frames with seats made of durable plastic or canvas that are simple to store.
5. **Basket stretcher:** The term "strokes basket" is occasionally used to describe this object. mostly uninhabited wilderness If there is a spinal injury, strap the patient to a backboard and place them inside a basket stretcher before moving them.
6. **Scoop stretcher:** Usually, this device is composed of aluminium or hard plastic. Because it divides vertically into two sections to scoop the patient up, the stretcher is known as a scoop stretcher. additionally known as an orthopaedic stretcher.
7. **Sprite board:** Backboards are another name for spine boards. When patients are discovered lying down, these are frequently employed. It typically measures 6 to 7 feet in length and contains holes for handles and strap attachment points.

## Literature survey:

Earlier versions of this type of robot were created for transportation-related industrial automation. With the development of technology, this type of robot is now utilised in Amazon's warehouse management. Not surprisingly, Amazon has introduced "SCOUT," a delivery robot that delivers packages to customers' homes. Despite not being a line-following robot, it uses a similar principle. The use of this robot for transportation was recently revived at Masdar City. Here, people used it as a means of transportation for themselves as well as products. Unfortunately, there has been little advancement in healthcare facilities that are automated. In order to make the transportation of medications, food, and injections to healthcare facilities easier, this study proposes an autonomous robot.

Project scope and expected outcome:

The goal of this study is to create a "smart stretcher" concept that will make evacuation easier and deliver advanced care closer to the site of the injury.

The smart stretcher's major objectives are to minimise time-consuming or repetitive manual chores in casualty care and evacuation and to lower the skill threshold for advanced resuscitative care.

1. Additional objectives and specifications include
  2. enabling modular functions that can be scaled in accordance with the knowledge and resources available
  3. optimised size, weight, and power for use at POI
  4. permitting hardware and software upgrades over time
  5. compatibility with automobiles
  6. Allowing for remote monitoring, communication, and control of automated medical equipment.
- Preventing the introduction of dangers through the achievement of crashworthiness, strong and rugged design, and simple operation. Automated medical equipment that is as safe as or safer than manual equipment.

7. This report's main objective is to investigate various smart stretcher subsystems and weigh their potential advantages against technology readiness.

Refined Project Plan:

Detailed schedule and milestones:

We first talked about the project's fundamental premise at multiple meetings where each participant presented their ideas. Second, we compiled a list of the supplies required for the job. We split the crew into two groups after deciding on the concept and course of action. One group is in charge of looking up similar works, while another is in charge of looking up sources of resources, among other things. A number of meetings have been scheduled to sketch out the project and make measurements and connection assumptions. Then we made the decision to create a smaller version of the project till we placed an order for all necessary materials. We started experimenting with the prototype using Tinker CAD to test the viability of our concept.

Later, we began to work on the hardware component and connect all of the wires for each gadget. Later, we began the programming phase, where we programmed and tested each individual sensor. Then, for the major project, we put all of the programming code together. To ensure that everything was operating as we desired, we tested the entire project using various conditions for each sensor. Then we split the team into two groups, one for writing reports and the other for working and looking for the programming-related software component. After then, everyone gathers to talk about the next steps in implementation. We added a stretcher model to the prototype based on our vision when the hardware component began to function.

## COMPONENTS:

### 1.SOFTWARE: ARDUINO IDE

The open-source software known as the Arduino IDE is used to create and upload code to Arduino boards. For different operating systems, including Windows, Mac OS X, and Linux, the IDE programme is appropriate. The programming languages C and C++ are supported. Integrated Development Environment is referred to in this sentence. The programme or code written in the Arduino IDE is often called as sketching. We need to connect the Genuino and Arduino board with the IDE to upload the sketch written in the Arduino IDE software. The sketch is saved with the extension '.ino.'

### 2.The IR Proximity Sensors:

A line follower robot's operation is based on the properties of light. We are aware that black absorbs the majority of the light, but white reflects practically all of the light that strikes it. We use infrared transmitters and receivers, also known as photodiodes, in the instance of a line-following robot. Light is transmitted and received through them. Infrared light is transmitted through IR.

When infrared light strikes a white surface, it bounces back and is captured by photodiodes, causing voltage changes. The photo diode does not receive any light or rays when infrared light strikes a black surface because the light is absorbed by the black surface and no rays are reflected back. This Arduino line-following robot is here.

### 3.L298N H-Bridge Motor Driver:

The Motor Drivers for the H-Bridge Since DC motors need far more current than the Arduino can supply, L298N is employed to operate them. The H-bridge arrangement used by the L298N motor controller is useful for controlling a DC motor's direction of rotation. Another advantage of employing an H-bridge is that we may provide the motors their own power source. This is especially important when using an Arduino board because two DC motors require a 5V power source, which is just insufficient. Motor A and Motor B terminals are available. To the microcontroller, these are connected. Unlike Motor B, which is connected to Terminals 3 and 4, Motor A is connected to Terminals 1 and 2.

#### 4.jumper wires

An electrical wire, or group of them in a cable, with a connector or pin at each end (or sometimes without them - simply "tinned") is known as a jump wire (also known as a jumper, jumper wire, or DuPont wire), and it is typically used to connect the parts of a breadboard or other prototype or test circuit, internally or with other machinery or components, without soldering.

#### 5.TT motors:

Plastic gear motors, commonly referred to as "TT," are a quick and affordable solution to make your projects move. It has a 1:48 gear ratio and two 200 mm wires with 0.1" male breadboard-compatible connectors. It is a TT direct current gearbox motor. Perfect for connecting to terminal blocks or a breadboard. These motors can be powered from 3 volts to 6 volts, while greater voltages will obviously cause them to move a little more quickly. By running an engine off of a stable power source, we were able to determine these statistics.

#### 6.Battery:

an electric battery that provides a nominal voltage of 9 volts is known as a nine-volt battery or 9-volt battery. depending on the battery chemistry, the actual voltage ranges from 7.2 to 9.6 volts. batteries of all shapes and sizes are produced; one popular size is pp3, which was first used in early transistor radios. the pp3 has two polarised snap connectors on the top and is shaped like a rectangular prism with rounded sides. this kind is frequently employed in a wide range of applications, including toys, clocks, and domestic items like smoke and gas detectors.

#### BLOCK DIAGRAM

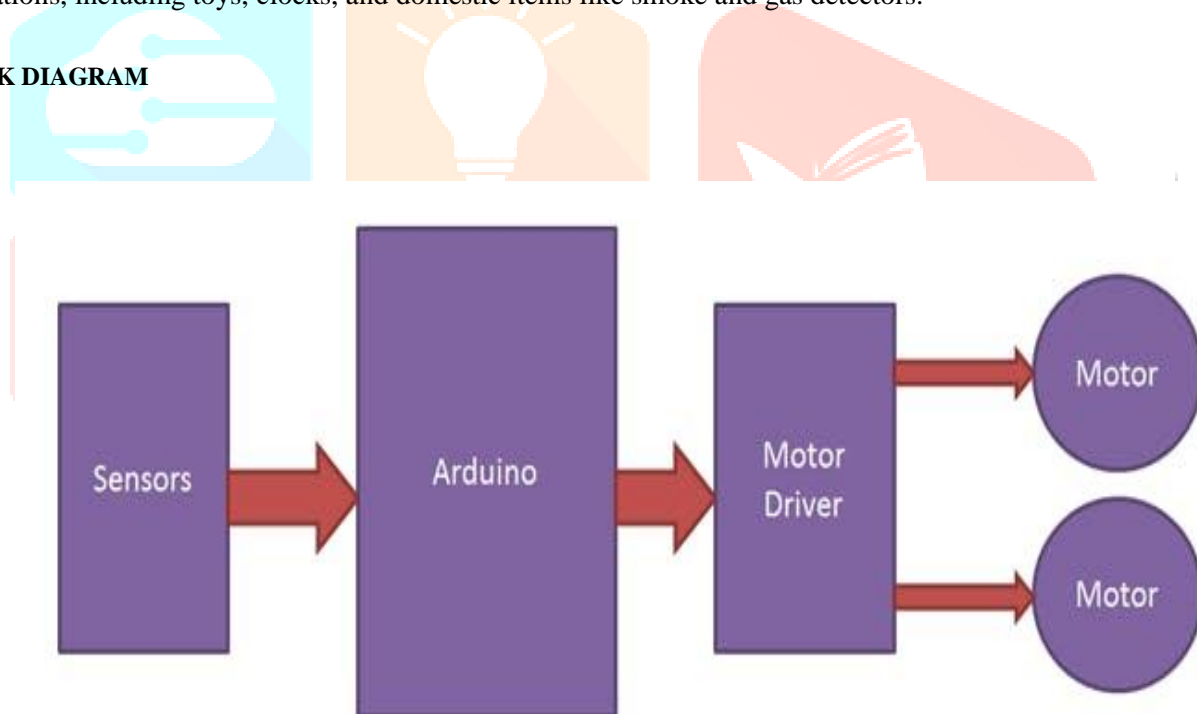

Line follower robot uses a sensor to find white surfaces and then passes the signal to an arduino. Arduino then drives the motors in accordance with the output provided by the sensors. In this setup, sensors, specifically left and right ir sensor modules, are used. When the right and left sensors are on the white route, the robot will advance. When the left sensor is on the black path and the right sensor is on the white path, the robot will turn left. When the right sensor is on a black route, an entirely different process takes place. Robot keeps going forward after recognising surfaces other than black ones. The robot will halt when both sensors are on a black surface.

## WORKING:

Sensors are utilised, as shown, to identify the line. Two IR Sensors with IR LED and photodiode are installed for line identification logic. When an IR LED comes close to a reflective surface, the photo diode will detect the light it emits. The infrared light emitted by the IR LED will be most strongly reflected because of the high percentage of light-colored surfaces that reflect light, and this light will be detected by the photodiode. The dark, black surface fully absorbs the light, making it impossible for it to reach the photodiode because of the low reflectance. We configured the IR sensors on the Line Follower Robot so that they are on each side of the black line using the same process. Both sensors watch for the line to be spotted as the robot travels forward. Think about it: if the IR Sensor RM detects the black line, it indicates that a right curve (or turn) is coming up.

The Arduino UNO recognises the fluctuation in colour and delivers the appropriate signal to the motor driver. The robot slows down its right motor using PWM in order to travel to the right. The motor on the left side is operating at regular speed concurrently. Similar to the previous example, if the IR Sensor RM or LM detects the black line first, it means that there is a right curve or left curve ahead and the robot needs to turn in that direction.

In order for the robot to turn left, the motor on its left side must be slowed down (or halted entirely, or spun in the other way), while the motor on its right side must continue to run at its regular speed. Arduino UNO continuously observes the information from both sensors and positions the robot along the line that was determined by them.

- The left sensor and right sensor IR sensor modules are used in this project. Robot advances when both left and right sensors detect white.

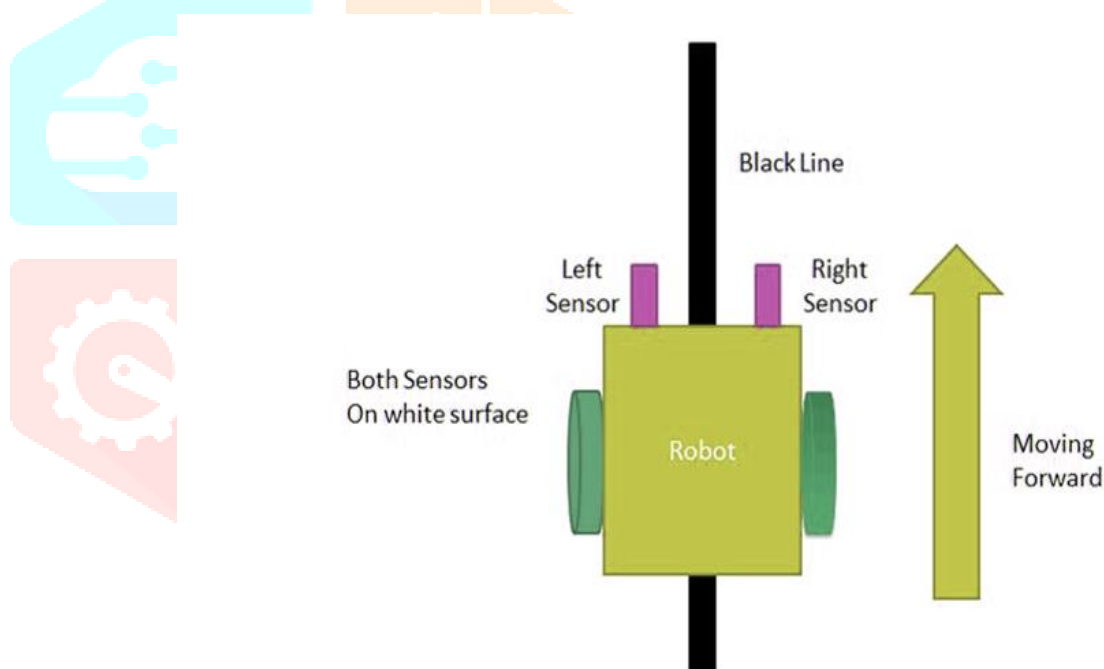

- If the left sensor detects a black line, the robot will turn to the left.

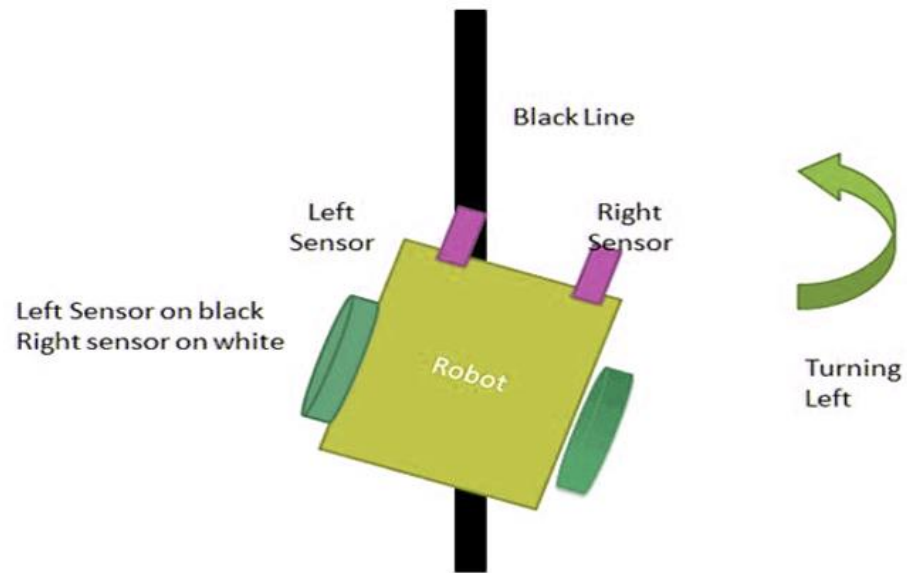

- If the right sensor detects a black line, the robot will turn right until the white surface is reached by both sensors. Robot resumes forward movement as soon as a white surface appears.

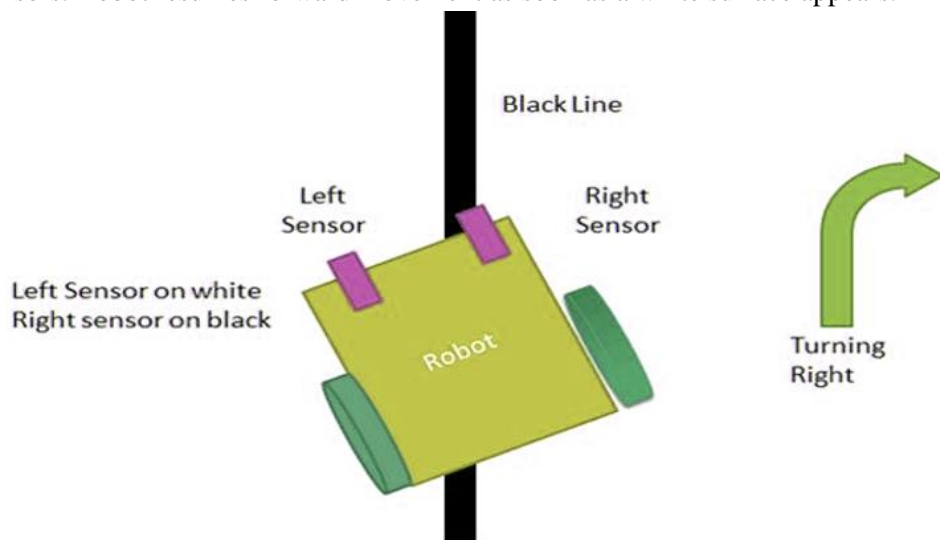



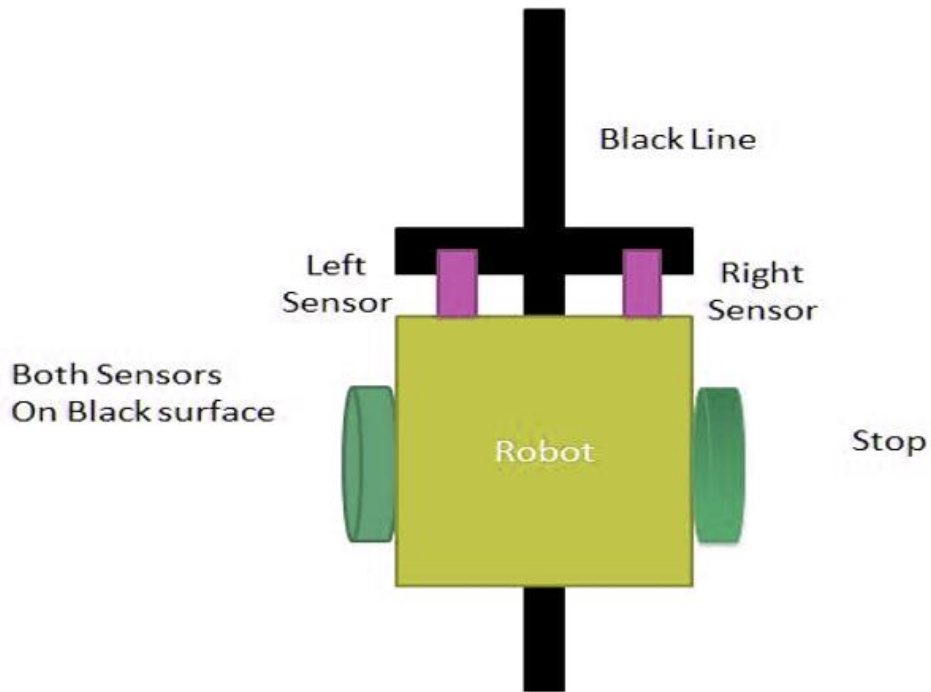

- The robot pauses if both sensors detect a black line

### CIRCUIT VIEW

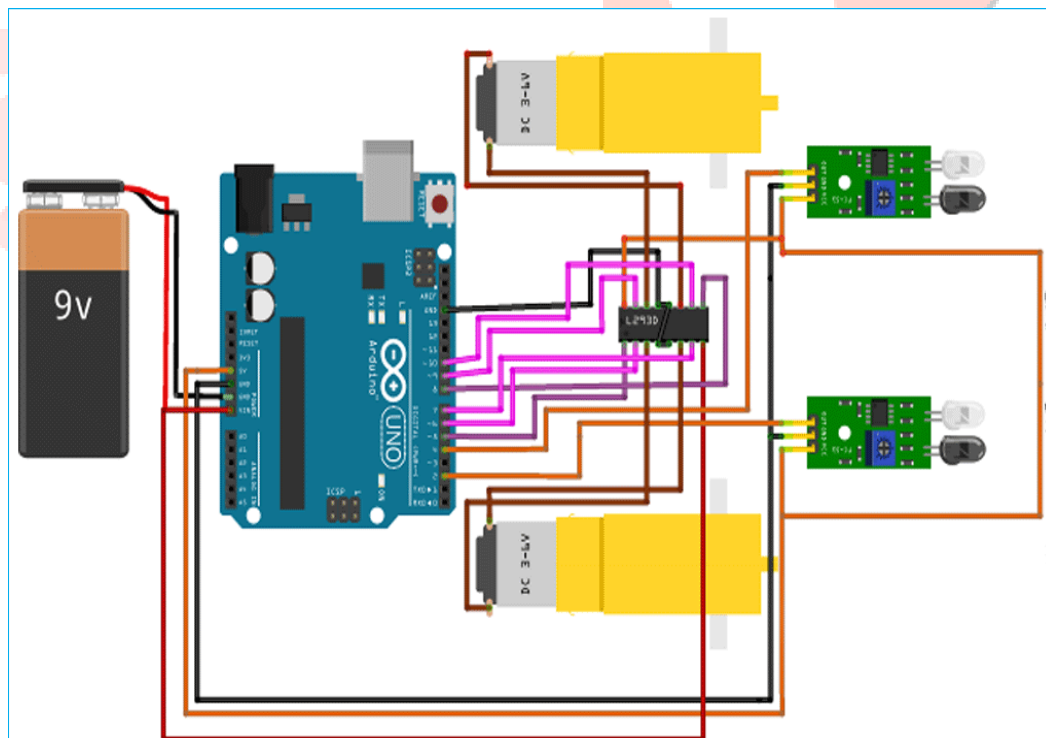

Pin connections:

Motor Drive Pin	Arduino Pin
Enable 1	5
Input 1A	6
Input 1B	7
Enable 2	8
Input 2A	9
Input 2B	10
Right Sensor	2
Left Sensor	4

Output:

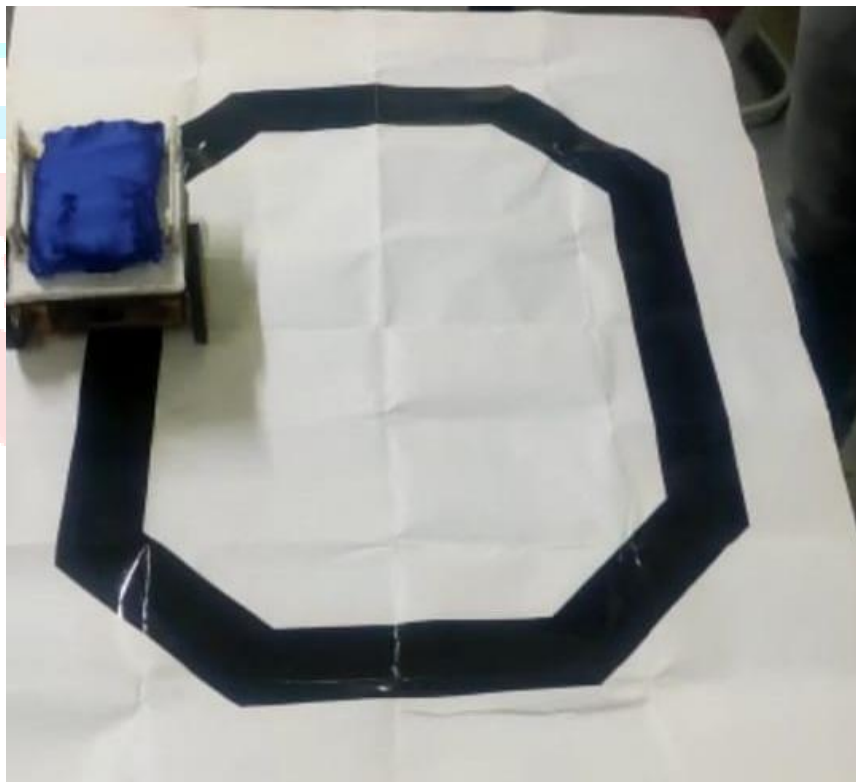



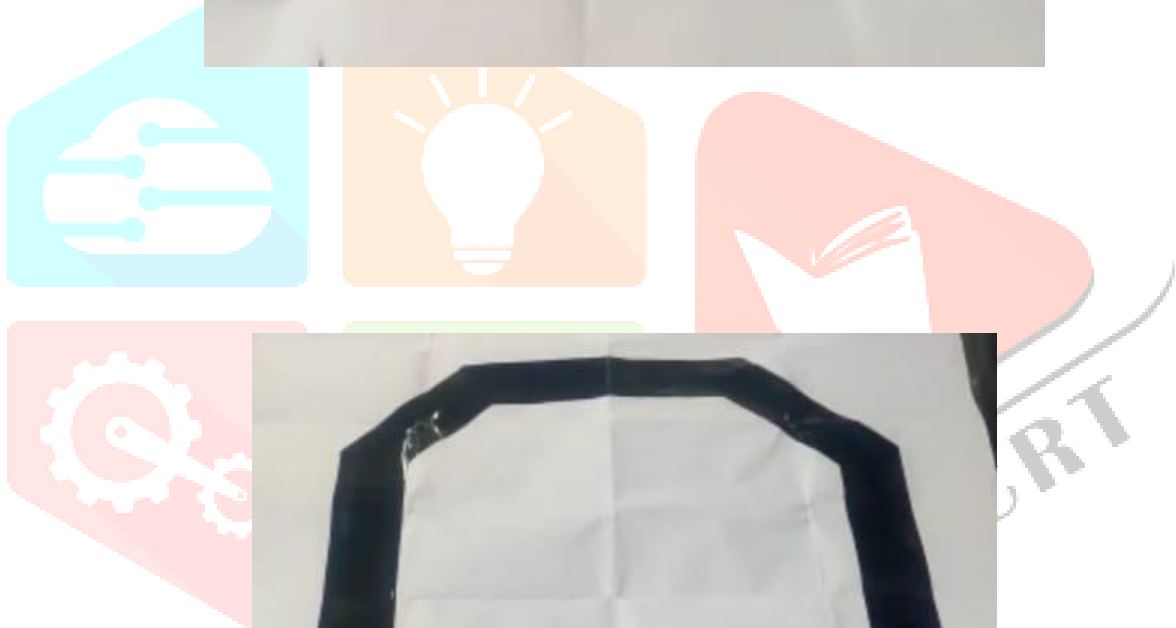
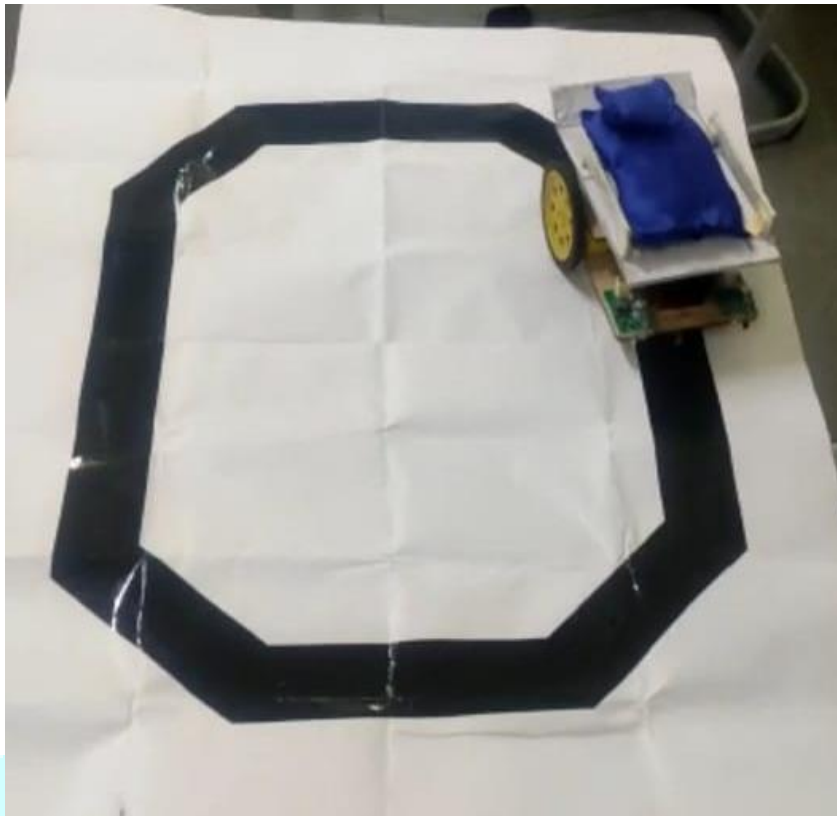

## CONCLUSION :

The DC motors of this robot are powered by a 9-volt battery. The motor's speed is directly proportional to the distance it travels. Due to battery drain, speed is decreased. If we employ this robot in a medical setting, it will not be able to handle heavy loads. This robotic device is a prototype. Practical mistakes will occur when it is really implemented in real time, but they can be fixed with better components and more time. It will be a useful application for healthcare facilities once it has been corrected. On overcoming the aforementioned constraints, high tech, top-notch robots could be designed.

## FUTURE WORK :

- By using this system as a foundation, further possibilities, such as mobile application control of the motor and wi-fi controlled monitoring, might be added to the system. These will increase the prototype's operational capacity and effectiveness.
- Using this method, it is also possible to deliver medical supplies and other equipment to their destination.
- Its use is extremely broad when combined with IOT.

## REFERENCES:

- [1] M.Zafri Baharuddin, "Analyst of Line Sensor Configuration for Advanced Line Follower Robot", University Tenaga Nasional.
- [2] Cao Quoc Huy, "Line Follower Robot", University UPG din Ploiesti.
- [3] P. Heyrati, A. Aghagani, "Science of Robot Disgn and Build Robot", Azarakhsh Publication, 2008.
- [4] M. Mashaghi, "Robotic Guide", Kanone Oloum Publication, 2008.
- [5] A. Kahe, "AVR Microcontroller", Nas Publication, 2007.
- [6] Robotic Competition Rolls site: <http://www.tjrc.ir/roles.asp> in date 2009/05/15
- [7] Hoare, S.; Kelly, M.P.; Prothero, L.; Barclay, S. Ambulance staff and end-of-life hospital admissions: A qualitative interview study. *Palliat. Med.* 2018,32, 1465–1473. [CrossRef]
- [8] Varghese, T. Innovation: The simple stretchers. *Med. J. Armed Forces India* 2003,59, 42–43. [CrossRef]
- [9] Armstrong, D.P.; Ferron, R.; Taylor, C.; McLeod, B.; Fletcher, S.; MacPhee, R.S.; Fischer, S.L. Implementing powered stretcher andload systems was a cost effective intervention to reduce the incidence rates of stretcher related injuries in a paramedic service. *Appl. Ergon.* 2017,62, 34–42.
- [10] .AZ Medical. Plastic Scoop Stretcher. 2020. Available online: <https://emslifes.com/product/scoop-stretcher/> (accessed on 3November 2020).