



EEG Classification for Brain Signal Detection

¹Dr.G.S.S.S.V. Krishna Mohan, ²D.Pravallika, ³B.Kishore, ⁴L.Vinay, ⁵P.Devakinandan

¹Professor, ^{2,3,4,5} Student

¹²³⁴⁵ Dept. of ECE, Aditya Institute of Technology and Management (A)-Tekkali, Andhra Pradesh

Abstract- Nowadays, brain signals are employed in various scientific and practical fields such as Medical Science, Cognitive Science, Neuroscience, and Brain Computer Interfaces. The brain signal analysis is faced with complex challenges including small sample size, high dimensionality and noisy signals. The detection of EEG brain signal in patient to distinguish between normal and abnormal which are tumor and epilepsy, therefore, a very demanding process that requires a detailed analysis of the entire length of the EEG data. This paper describes an automated classification of EEG signals for the detection of normal and abnormal using NSCT and ANN Classifier. Feature extracted from input EEG signals. The performance of the proposed algorithm has been evaluated using in EEG signals. The results showed that the proposed classifier has the ability of classifying EEG signals efficiently.

Keywords-EEG, NSCT, ANN.

1. INTRODUCTION

The disease that affects the human brain due to the disorder in neurological central system. The abnormal activity of brain cells are triggered by this brain diseases. Electroencephalogram (EEG) is currently used for acquiring the abnormal activities that occur in the brain. The brain diseases can be detected by analyzing the abnormal activities in the observed signals. The brain signals can be classified into three types: normal signal, abnormal epilepsy. The patients who are affected by primary epilepsy are 20% and that of the focal epilepsy is 80% as per the report of World Health Organization 2010. The signals from the brain area are classified into either focal or nonfocal. The signal that comes from the abnormal brain cells is called as focal signal, and the signal that comes from the normal brain cells is called non focal signal. Hence, the epilepsy disease is detected by differentiating and detecting the focal signal from nonfocal signal. Certain signal processing techniques have been developed for detecting the epilepsy disease by differentiating the focal from nonfocal signals. The severity analysis of the focal signal is also required for the patient before surgery. The severity may either be “early” or “advance” and the surgery is needed for those patients with “advance” severity level. The decomposition of EEG signal will help the radiologist to detect the focal behavior of the signal through the extracted features from each of the decomposed subband layers. Empirical mode decomposition (EMD), linear prediction decomposition, and nonlinear mode decomposition are the conventional methods for decomposing the EEG signal in order to detect the focal and nonfocal EEG signals. The stationary property of the EEG signals cannot be detected and diagnosed using these decomposition methods⁴. Hence, this study uses dual-tree complex wavelet transform for decomposing the EEG signals in order to analyze the stationary behavior of the signals. Figure 1a shows the normal activity of brain using EEG signal in nonfocal mode and the abnormal activity of brain in focal mode.

This article is organized as follows: states the conventional classification methods of EEG signals. proposes an automated methodology for the classification of EEG signal using machine learning algorithm and discusses the experimental results performed on an open-access data set EEG signals for epilepsy disease detection. concludes this article.

2. LITERATURE SURVEY

Many automated EEG signal classification systems using different approaches have emerged in recent years. Among such studies, Madhava et al⁵ presented a system for differentiating the focal signals from nonfocal signals using deep convolutional networks based on time- frequency domain. Artificial neural network (ANN) was applied on EEG signals for decomposing the signals. Then, the time-frequency features were extracted from the decomposed SST and these features were classified using ANN classification algorithm. The authors obtained a classification accuracy of 99% on Bern-Barcelona EEG data set. Rahul Sharma et al⁶ utilized third-order cumulant function for the automatic detection of focal EEG signals. The features were extracted from the EEG signals using Nonsubsampled contourlet transform

(NSCT), method and then these features were classified using Artificial neural network (ANN) classification technique. The authors obtained a maximum classification accuracy of 99% on Bern-Barcelona EEG data set. Siddharth et al⁷ developed a method for discriminating the focal signals from non-focal EEG signals using sliding mode singular spectrum analysis method. The reconstructed component features were computed from EEG signals and those features were classified using radial basis function neural network. The authors tested their proposed method on the EEG signals of the Barcelona EEG data set and obtained an average accuracy of 99.11%, an average sensitivity of 98.52%, and an average specificity of 99.7%. Rahul Sharma et al⁸ presented a bi spectrum method in order to extract 25 magnitude features from EEG signals. These features were obtained by using NSCT method and then the computed features were classified using ANN classification approach. The authors used 10-fold cross validation approach on the EEG signals of the Barcelona EEG data set and obtained a classification accuracy of 96.2%. Gupta et al⁹ implemented the EMD method on the EEG signals. Then, Sharma-Mittal entropy features were computed from each of the decomposed subbands. These nonlinear features were classified using ANN classification approach and the authors had obtained a maximum classification accuracy of 83.18% on the EEG signals available in Barcelona EEG data set. Yuan et al.¹⁰ detected seizure points in the EEG signals using deep learning algorithms. The inter-correlation and intra correlation features between each of the variation points in the EEG signals were computed, and those correlation features were classified using multi-view method. Fivefold cross validation method was incorporated for testing the effectiveness of the proposed EEG signal classification.

3. MATERIAL AND METHODS

In this study, shear let transform-based random forest (RF) classification approach is used for the classification of focal and nonfocal EEG signals. Initially, the features are extracted from the coefficients of the shear let transform. Then those features are optimized using genetic algorithm and finally the optimized features classified using RF classification approach. Figure 2 shows the proposed EEG signal classification using RF classification approach.

3.1. Materials

This study uses the Bern-Barcelona EEG data set²⁷ for the classification of EEG signals. This is an open-access data set and was created in the year 2012, which was permitted all the researchers to use the acquired EEG signals. The EEG signals in this data set are obtained from five patients over a period of 80 hours at the Neurology Department of the Bern University. This data set contains 7500 pairs of EEG signals and these signals are categorized into focal (3750) and nonfocal EEG signal (3750). All these EEG signals are quantized at the frequency range of 512 Hz for a time duration of 20 seconds. Each EEG signal in this data set is represented by its X- and Y-channel, respectively. From this dataset, 750 focal and 750 nonfocal EEG signals are obtained for evaluating the performance of the proposed method. The signals used in this study are further split into training and testing data set. The training data set contains 150 focal and 150 non-focal EEG signals. The testing data set contains 350 focal and 350 nonfocal EEG signals. The EEG signals in both of the training and testing data sets are independent of each other.

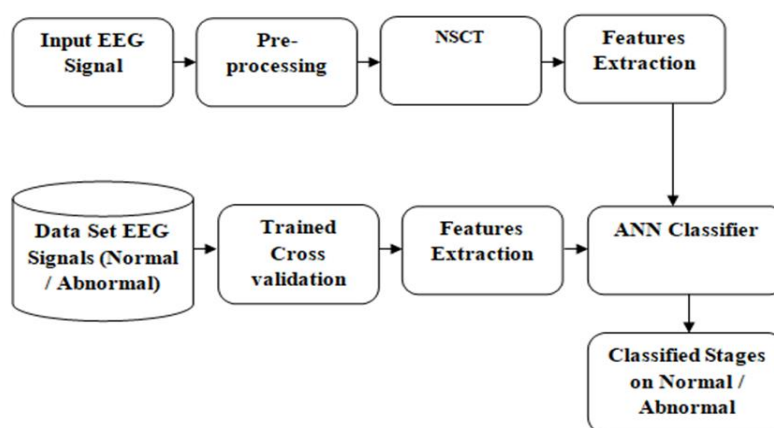

Figure1- Proposed methodology for electroencephalogram (EEG) signal classifications

3.2. Methods

The nonsubsampled contourlet transform (NSCT) is applied on the EEG signal which decomposes the source signal into approximate and directional sub bands. The features are extracted from those sub bands and then they are finally classified by ANFIS classification method. Figure1 shows the proposed methodology for the classifications of EEG signal.

3.3 Nonsubsampled contourlet transform

In this study, three-level decomposition is carried out on EEG signals using NSCT. The NSCT consist of non-subsampled pyramid filter bank (NSPF) and non- subsampled directional filter bank (NSDF). First, the EEG signals are passed through NSPF, which decom- poses the signal into low-pass and high-pass signals. The high-pass signals are passed through NSDF, which produces directional sub bands. At decomposition stage 2, the low-pass sub band signals are passed through NSPF, which produces low- and high-frequency sub bands. This high-frequency sub band signals are again passed through NSDF for obtaining the directional sub bands. This pro- cess is repeated for the third-stage decomposition also. Figure 3 shows the decomposition of EEG signals using three-level NSCT. In this study, MATLAB toolbox NSCT is used for decomposing the EEG signals into approximation and directional sub bands.

3.4 Feature extractions

The focal and nonfocal EEG signals can be differentiated with the help of features that are extracted from the decomposition sub bands. Characteristic feature vector (CFR), probability density function (PDF), mutual information (MI) features, energy and pattern spectrum entropy (PSE) features are extracted for the classification of EEG signals.

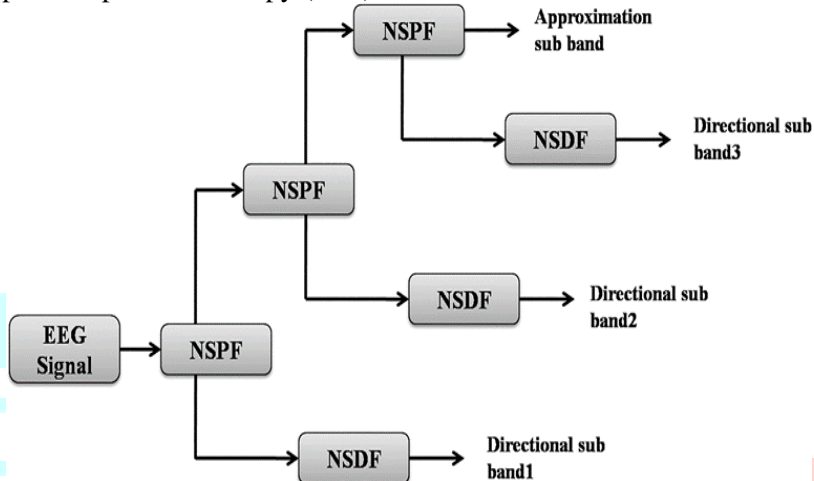

Figure 2- Decomposition of electroencephalogram (EEG) signals using three-level nonsubsampled contourlet transform

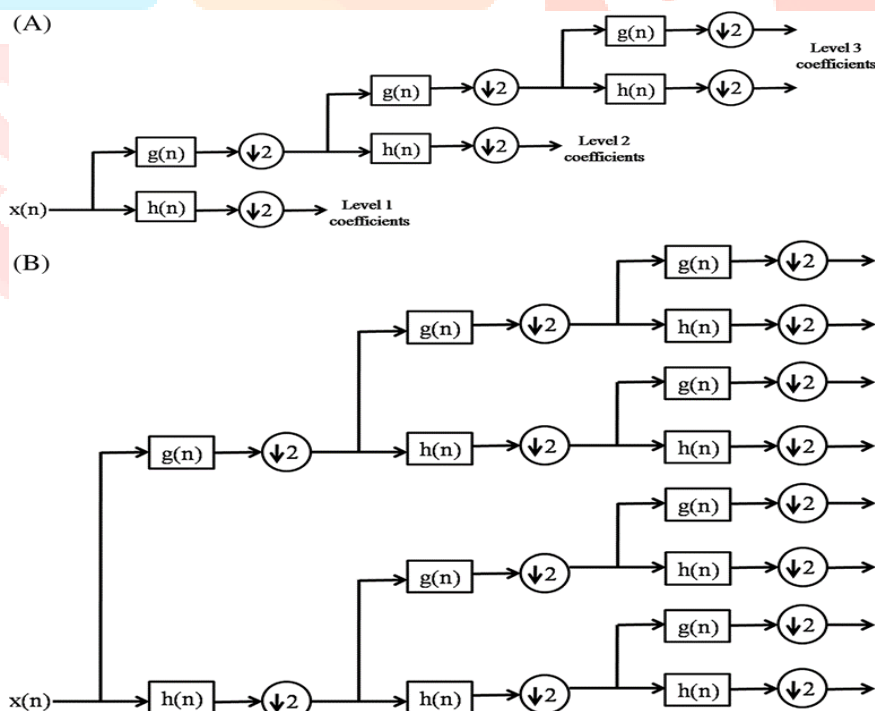

Figure 3- Third level decomposition of electroencephalogram (EEG) signal: A, wavelet decomposition of signal; B, wavelet packet decomposition of signal.

3.5 Characteristic feature vector

In this study, the CFR features were computed by decomposing the EEG signals with the help of wavelet packet decomposition (WPD) method. It is the extension of wavelet decomposition (WD), in which the signals can be passed through low-pass filter (LPF) $g(n)$ and high-pass filter (HPF) $h(n)$ with decimation factor 2. The LPF produces approximation sub bands and HPF produces detailed sub- bands, at level 1 of the decomposition. At level 2 of the decomposition, the approximation sub bands are again pas- sed through LPF and HPF, which produces approximation and detailed sub bands. This process is repeated until level3 coefficients are obtained. The main function of DWT is to convert the signals from time domain representation into frequency domain representation.

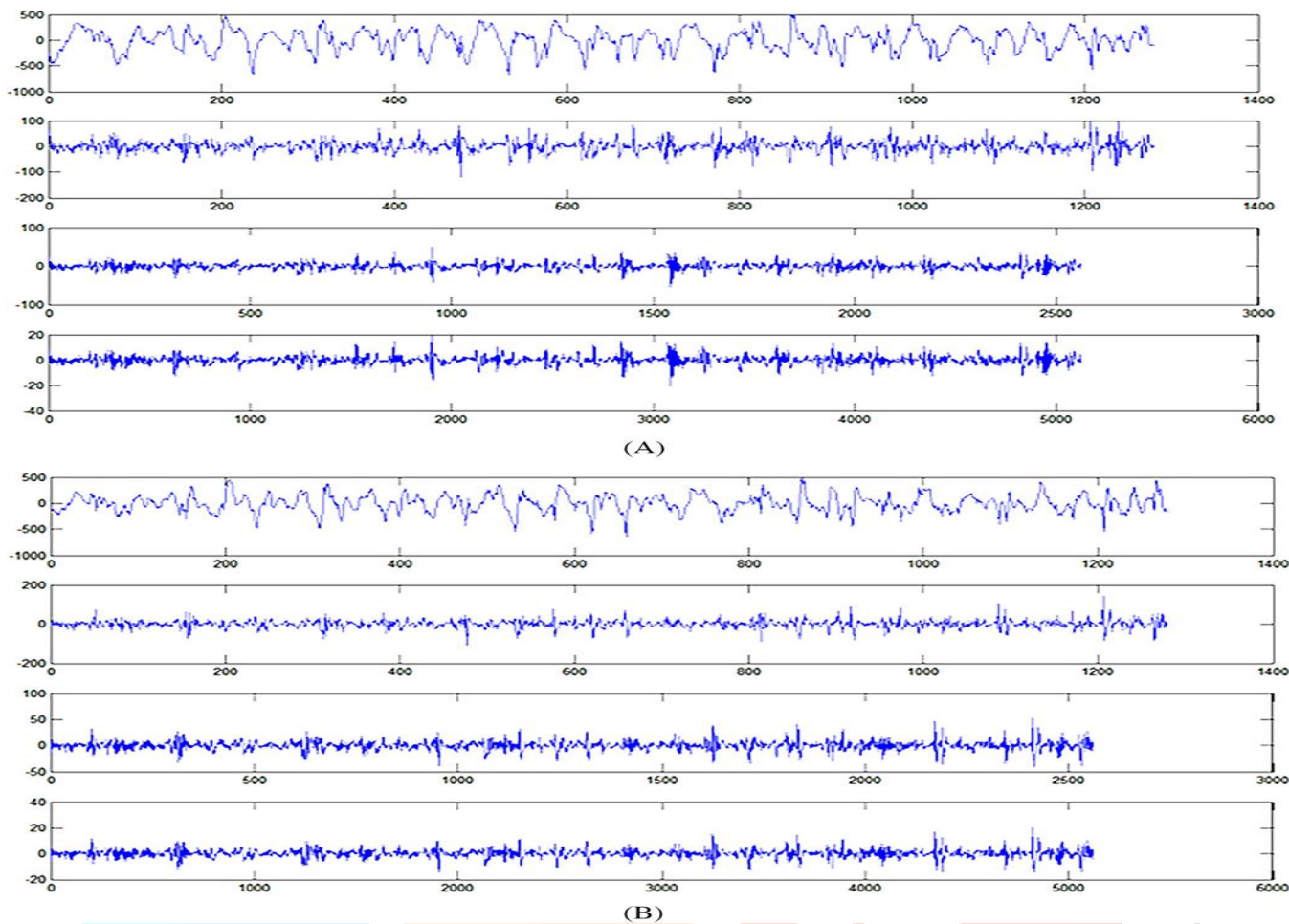

Figure 4- Level 3 decomposition of electroencephalogram (EEG) signal: A, wavelet packet decomposition (WPD) of X-channel;(B) WPD of Y-channel

The main limitations of this filter is that its time resolution is reduced and frequency resolution is increased at each of the consecutive stages of decomposition. The produced frequency resolution bands are not of the same size. This will create the frequency instability on decomposed sub bands as depicted in Figure 4a. In order to overcome the limitation of WD, WPD is used for decomposing the EEG signals, in which the signals passed through LPD and HPD produce approximation and detailed sub bands, respectively. At the level 2 of decomposition, the approximation and detailed sub bands are passed through LPF and HPF in order to produce equal frequency sub bands. This process is repeated until level 3 coefficients are obtained as shown.

the WPD of X-channel shows the WPD of Y-channel at the level 3 of the decomposition stages. From the level 3 sub band decomposition of WPD, the energy factors are computed for each of the sub bands S_{3j} using the following equation:

$$E_j = \sqrt{\sum_{j=0}^7 |s_{3j(l)}|^2} \tag{1}$$

Then, the Eigen vectors are computed using energy factors of each of the individual sub bands at level 3 with the help of the following equation:

$$E = \sqrt{\sum_{j=0}^7 e_j^2} \tag{2}$$

The CFR is computed using Eigen vectors and individual energy factors for each of the sub bands at the level 3 of decomposition using the following equation:

$$CRF = \frac{e_j}{e} \quad j=0, \dots, 7 \tag{3}$$

3.6 Mutual information features

The mutual information features are computed between X- and Y-channel of the EEG signals. The MI between X and Y-channel of the EEG signals is computed using the following equation:

$$MI = Entropy(X) - Entropy(Y) + Joint Entropy(X,Y) \dots\dots\dots 7$$

The MI between Y- and X-channel of the EEG signal is computed using the following equation:

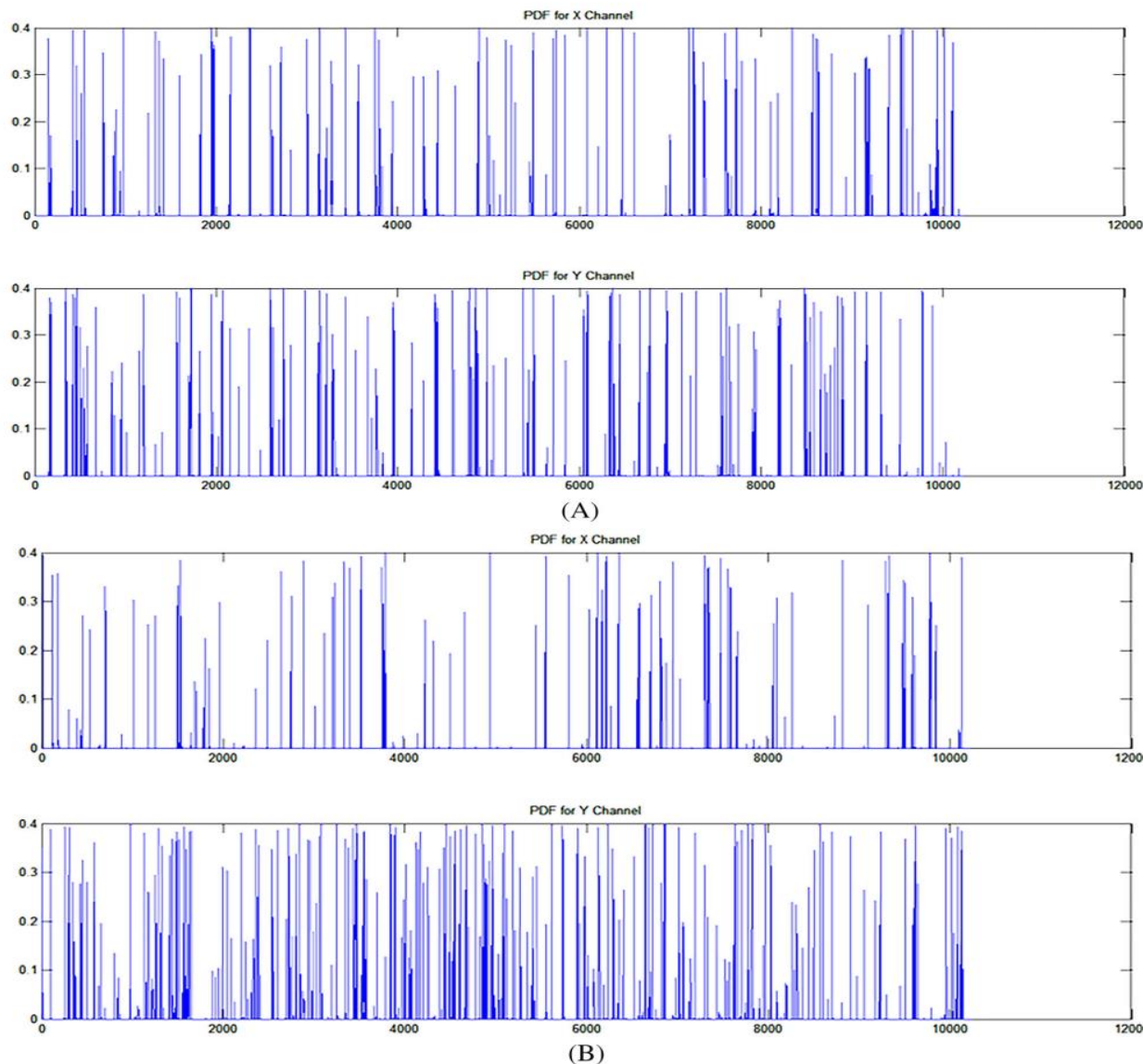

Figure 5- Probability density function (PDF) features of X- and Y-channel: A, focal signal; B, nonfocal signal

3.7 Energy features

The energy level of the quantitative sampling points in the EEG signal represent the energy level of the signal for the given time period. The focal and nonfocal EEG signals can have different energy levels with respect to its sampling point variations.

The energy feature of X-channel is computed as

$$E1 = \sqrt{\sum_{i=0}^{N-1} xi^2} \quad (8)$$

The energy feature of Y-channel is computed as

$$E2 = \sqrt{\sum_{i=0}^{N-1} Yi^2} \quad (9)$$

4.SIMULATION RESULTS

4.1: Normal case

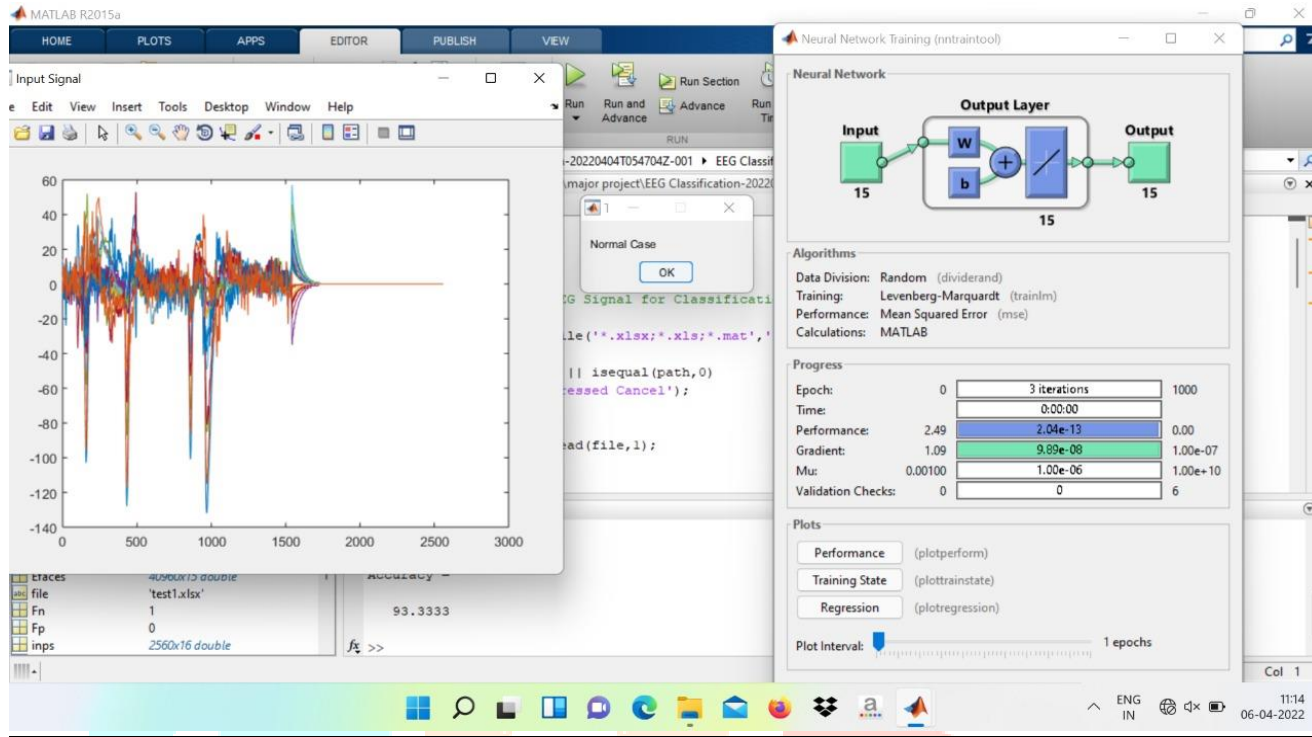

Figure 6- Input signal and simulation results of normal case

4.2: Tumor case

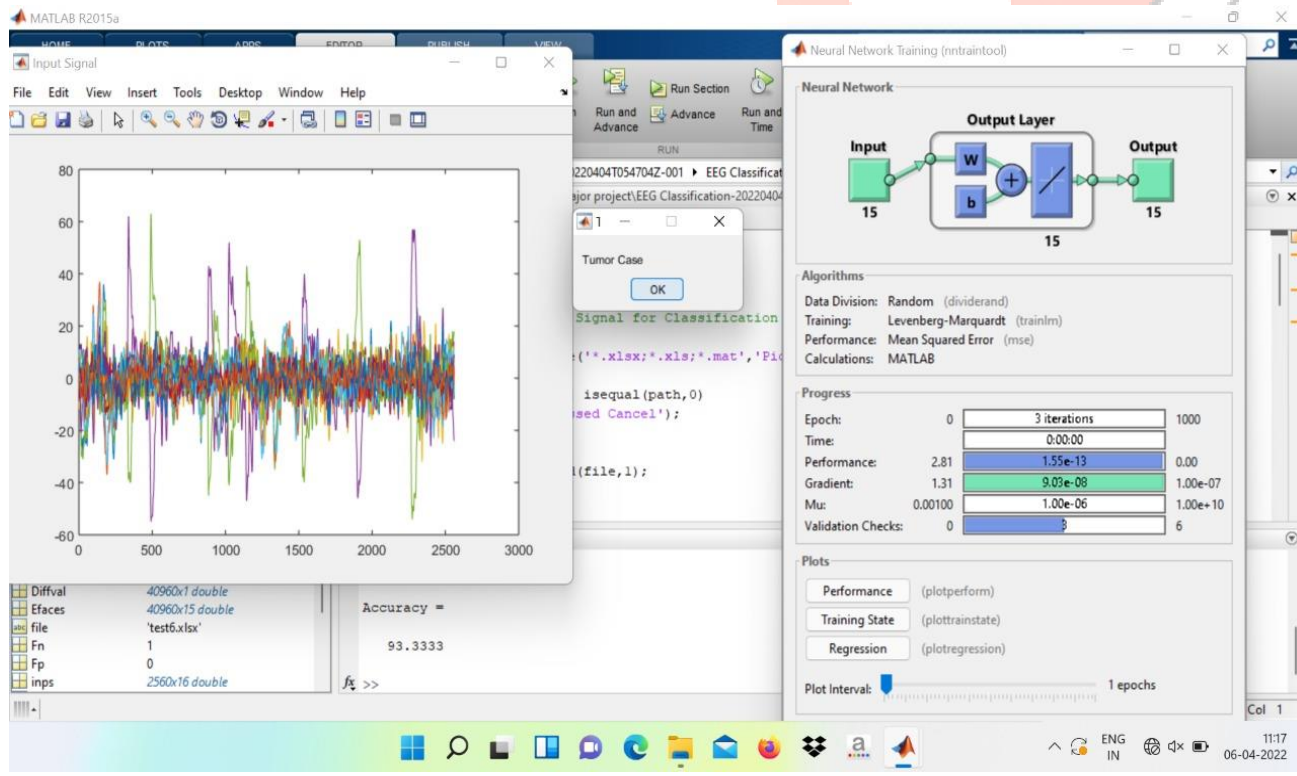

Figure 5- Input signal and simulation results of Tumor case

4.3: Epilepsy case

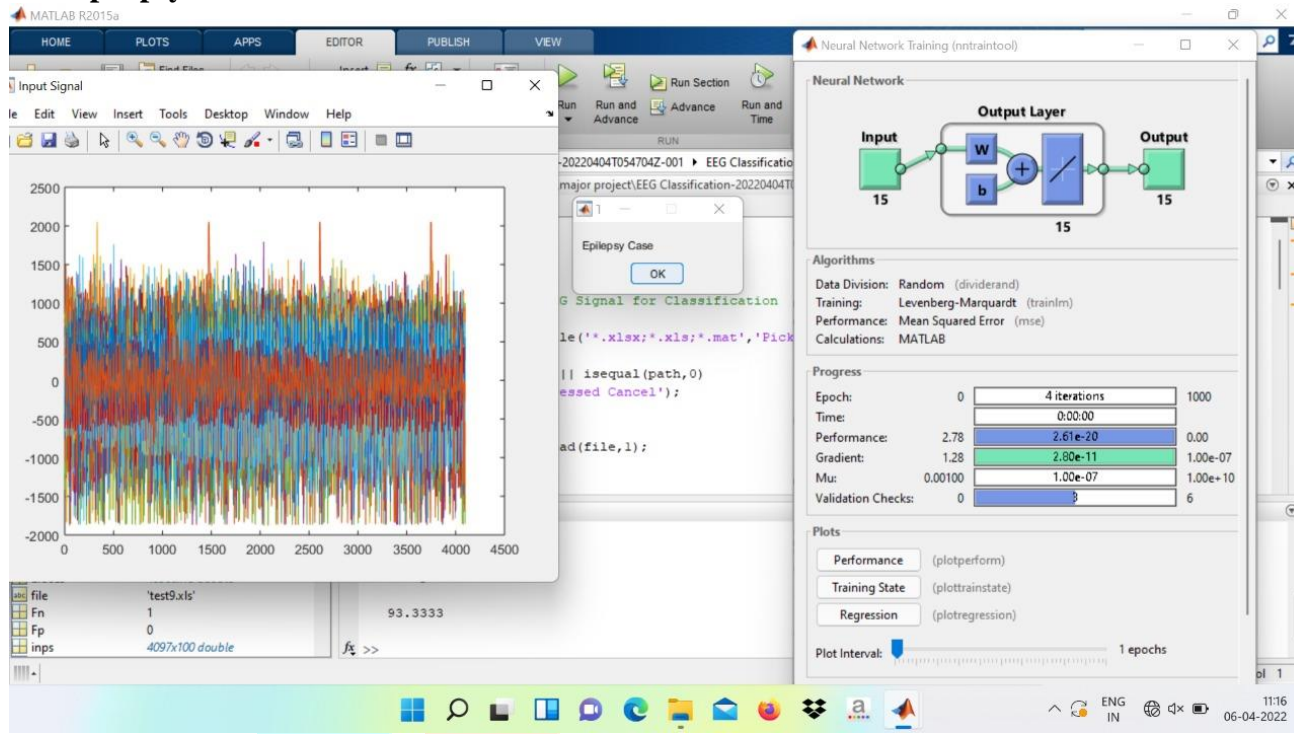

Figure 7- Input signal and simulation results of epilepsy case

5. CONCLUSION

This project presented an EEG data classification methodology, makes the decision about the brain state of the patient. This work uses NSCT for decomposing the EEG signals and then features are extracted from the decomposed subbands. Then, ANN classification algorithm is used to classify the source EEG signal into focal and nonfocal. The proposed methodology for EEG signal classification system achieves higher accuracy (99.4%), sensitivity (99.7%), and specificity (99.7%) with 99.4% of classification rate.

Therefore, the conclusion is that the proposed method can be used to classify EEG signals in an effective manner. The simulation results of the proposed methodology are compared with conventional methodologies. There are future improvements that can be done by implementing it using deep learning algorithms. Though they will definitely result in a more complex analysis yet will give us more accurate classification results for EEG severity diagnosis system in future. Also the detection capabilities should be identified by analyzing long-term continuous EEG recordings.

7. REFERENCES

- [1] Sharma R, Pachori RB, Gautam S. Empirical mode decomposition based classification of focal and non-focal EEG signals. Proc Int Conf Med Biometrics. 2015;1:135-140.
- [2] Gupta V, Pachori RBA. New method for classification of focal and non-focal EEG signals. Machine intelligence and signal analysis. Advances in Intelligent Systems and Computing. Vol 748. Singapore: Springer; 2019.
- [3] Yuan Y, Xun G, Jia K, Zhang A. A multi-view deep learning framework for EEG seizure detection. IEEE J Biomed Health Inform. 2019;23(1):83-94.
- [4] Gupta S, Krishna KH, Pachori RB, Tanveer M. Fourier-Bessel series expansion based technique for automated classification of focal and non-focal EEG signals. International Joint Conference on Neural Networks (IJCNN), Rio de Janeiro. Rio de Janeiro, Brazil: IEEE; 2018:1-6.
- [5] Bhattacharyya A, Sharma M, Pachori RB, Sircar P, Acharya UR. A novel approach for automated detection of focal EEG signals using empirical wavelet transform. Neural Comput Appl. 2018;29:47-57.
- [6] Kolekar MH, Kumar V. Automated classification of focal and non-focal EEG signals based on bivariate empirical mode decomposition. Biomed Signal Image Process Patient Care. 2017;1:1-20.
- [7] Gupta V, Priya T, Kumar A, Pachori RB, Rajendra Acharya U. Automated detection of focal EEG signals using features extracted from flexible analytic wavelet transform. Pattern Recogn Lett. 2017;94:180-188.
- [8] Truong ND, Nguyen AD, Kuhlmann L, Bonyadi MR. Integer convolutional neural network for seizure detection. IEEE J Emerg Select Topic Circuits Syst. 2018;8(4):849-857.
- [9] Pushpendrasingh PRB. Classification of focal and nonfocal EEG signals using features derived from fourier-based rhythms. J Mech Med Biol. 2017;17(07):1-16.

[10] Sharma R, Kumar M, Pachori RB, Acharya UR. Decision support system for focal EEG signals using tunable-Q wavelet transform. J Comput Sci. 2017;20:52-60.

8. BIOGRAPHIES

1. G.S.S.S.V. Krishna Mohan, Associative Professor, Dept. of ECE-Aditya Institute of Technology and Management-Tekkali, Andhra Pradesh. PhD Area: Signal Processing.
2. Bammidi Kishore, B.Tech (ECE) student from Aditya Institute of Technology and Management-Tekkali, Andhra Pradesh.
3. Dharmana Pravallika, B.Tech (ECE) student from Aditya Institute of Technology and Management-Tekkali, Andhra Pradesh.
4. Lingam Vinay, B. Tech (ECE) student from Aditya Institute of Technology and Management-Tekkali, Andhra Pradesh.
5. Pedada devakinandan, B.Tech (ECE) student from Aditya Institute of Technology and Management-Tekkali, Andhra Pradesh.

