



## PERFORMANCE ANALYSIS OF PV MODULE WITH TRACKER AND CLEANING SYSTEM

ABHISHEK M<sup>1</sup>, CHANDAN N<sup>2</sup>, NEELALOCHANA C N<sup>3</sup>, SHWETHA P<sup>4</sup>  
Dr. SUREKA MANOJ<sup>5</sup>

<sup>1</sup>Student(4VM19EE001), ELECTRICAL AND ELECTRONICS ENGINEERING, VVIET, MYSORE, INDIA

<sup>2</sup>Student(4VM20EE405), ELECTRICAL AND ELECTRONICS ENGINEERING, VVIET, MYSORE, INDIA

<sup>3</sup>Student(4VM19EE025), ELECTRICAL AND ELECTRONICS ENGINEERING, VVIET, MYSORE, INDIA

<sup>4</sup>Student(4VM19EE043), ELECTRICAL AND ELECTRONICS ENGINEERING, VVIET, MYSORE, INDIA

<sup>5</sup>PROF. & HEAD OF, ELECTRICAL AND ELECTRONICS ENGINEERING, VVIET, MYSORE, INDIA

### MODULE

**Abstract:** Renewable energy resources supply almost 40% of the total world energy demand. It includes biomass, hydropower, geothermal, solar, wind & tidal energy. These works concentrate on solar energy which is abundantly available in direct as well as indirect form. In indirect form solar energy can be converted into electricity using photovoltaic cells. The idea is unique in that with the solar tracker, the system also includes an automated solar panel cleaning. This opens up the new field to build an automatic solar tracker which comes with the automatic panel cleaning. The project uses a dummy solar panel which is coupled to a DC stepper motor for tracking the sun rays such that maximum sunlight is incident on the solar panel at any given time of the day. The tracking movement of the solar panel is achieved by teaming a DC stepper motor with the solar panel such that the face of the panel is always perpendicular to the sun, so as to generate maximum energy. This is attained by utilizing a programmed 8051 microcontroller/arduino to furnish stepped pulses in specific time intervals for the DC stepper motor to rotate the solar panel appropriate with geographical terrain.

The cleaning mechanism can be achieved by a DC servo motor which is coupled to the solar panel with brushes. The DC servo motor is also connected to the microcontroller/arduino which is programmed to send signals for cleaning mechanism to operate after LDR sensor sends signal for regular cleaning. This work presents a novel method of finding a more economical and efficient system that not only ensures maximum amount of sunlight but also helps in the maintenance of solar panel.

**Keywords:** Arduino UNO, Solar panel, Stepper motor, Servo motor, Sensors.

#### I. INTRODUCTION

One of the most promising renewable energy sources characterized by a huge potential of conversion into electrical power is the solar energy. The conversion of solar radiation into electrical energy by Photo-Voltaic (PV) effect is a very promising technology, being clean, silent and reliable, with very small maintenance costs and small ecological impact. The interest in the Photo Voltaic conversion systems is visibly reflected by the exponential increase of sales in this market segment with a strong growth projection for the next decades. According to recent market research reports carried out by European Photovoltaic Industry Association (EPIA).

The continuous evolution of the technology determined a sustained increase of the conversion efficiency of PV panels, but nonetheless the most part of the commercial panels have efficiencies no more than 40%. A constant research preoccupation of the technical community involved in the solar energy harnessing technology refers to various solutions to increase the PV panel's conversion efficiency. Among PV efficiency improving solutions we can mention: solar tracking, optimization of solar cells geometry, enhancement of light trapping capability, use of new materials, etc. The output power produced by the PV panels depends strongly on the incident light radiation.

A **Solar Tracker** is a device onto which solar panels are fitted which tracks the motion of the sun across the sky ensuring that the maximum amount of sunlight strikes the panels throughout the day. The Solar Tracker will attempt to navigate to the best angle of exposures of light from the sun. This report aims to let the reader understand the project work which I have done. A brief

introduction to Solar Panel and Solar Tracker is explained in the Literature Research section. Basically the Solar Tracker is divided into two main categories, hardware and software. It is further subdivided into six main functionalities: Method of Tracker Mount, Drives, Sensors, RTC, Motors, and Power Supply of the Solar Tracker is also explained and explored. The reader would then be brief with some analysis and perceptions of the information.

The **PV Automatic Cleansing** powers performances are affected. by the particles weights of the dusts and weather situation hence, we can performed that in deserts regions, the electrical powers losses can tends to 40 % if different losses are noted likes Aging effects Seasons temperature variation Heats result of solar radiation dirt & soiling effects. In usual ways, cleaning.& cooling. represents obvious ways to improve the system performances. Showing one side dusty and cleaned panel in fig.1.5



Fig.1.5 Showing half side clean and dusty panel

Accumulation of dirt or particles like dust, water, sand and moss on the surface of solar photovoltaic panel obstruct or distract light energy from reaching the solar cells. This is a major problem since the light obstruction materials pose as external resistances that reduce solar photovoltaic performance. The present work was performed to analyze the effects of accumulation of such dirt or particle son the output performances of solar panel. Experiments using different obstruction materials were conducted under controlled conditions using spotlights to simulate source of solar radiation. It was found that the external resistance could reduce the photovoltaic performance by up to 85%.

### 1.1 Causes of Dust Accumulation in Panel:

Efficiency will be decreases

Soiling a Problem from the Start

Since solar power first became widely accepted decades ago, scientists have toiled to improve the efficiency of PV panels and to bring down the cost of producing electricity from the sun. Those were the big tasks. Now, with solar providing an increasing percentage of the nation's power needs at a low cost, researchers have turned to secondary problems with the technology. "We made it," said Matthew Muller, an engineer at NREL who specializes in the reliability and performance of PV. "Solar's getting deployed, but we're losing energy because solar's getting deployed in dusty locations."

The energy lost annually from soiling amounts to as much as 17% in parts of the United States to as high as 50% in the Middle East. Rain and wind can be enough to scour some dust from PV panels, said Lin Simpson, who served with Muller as the co-principal investigator at NREL for a \$6 million Department of Energy-funded research effort into soiling. However, because PV panels cool down at night and attract morning dew, the dust can go through a process called cementation. And the cause of dust accumulation as shown in below diagram.

### Why is it important to clean solar panels?

It is very important to clean your solar panels. Dirt on the solar panels prevents the entry of light. Moreover, solar panels are made to work by allowing light enters the solar cells. Bird poop, dust or pollen prevent the light from reaching the solar cells which eventually leads to less energy production

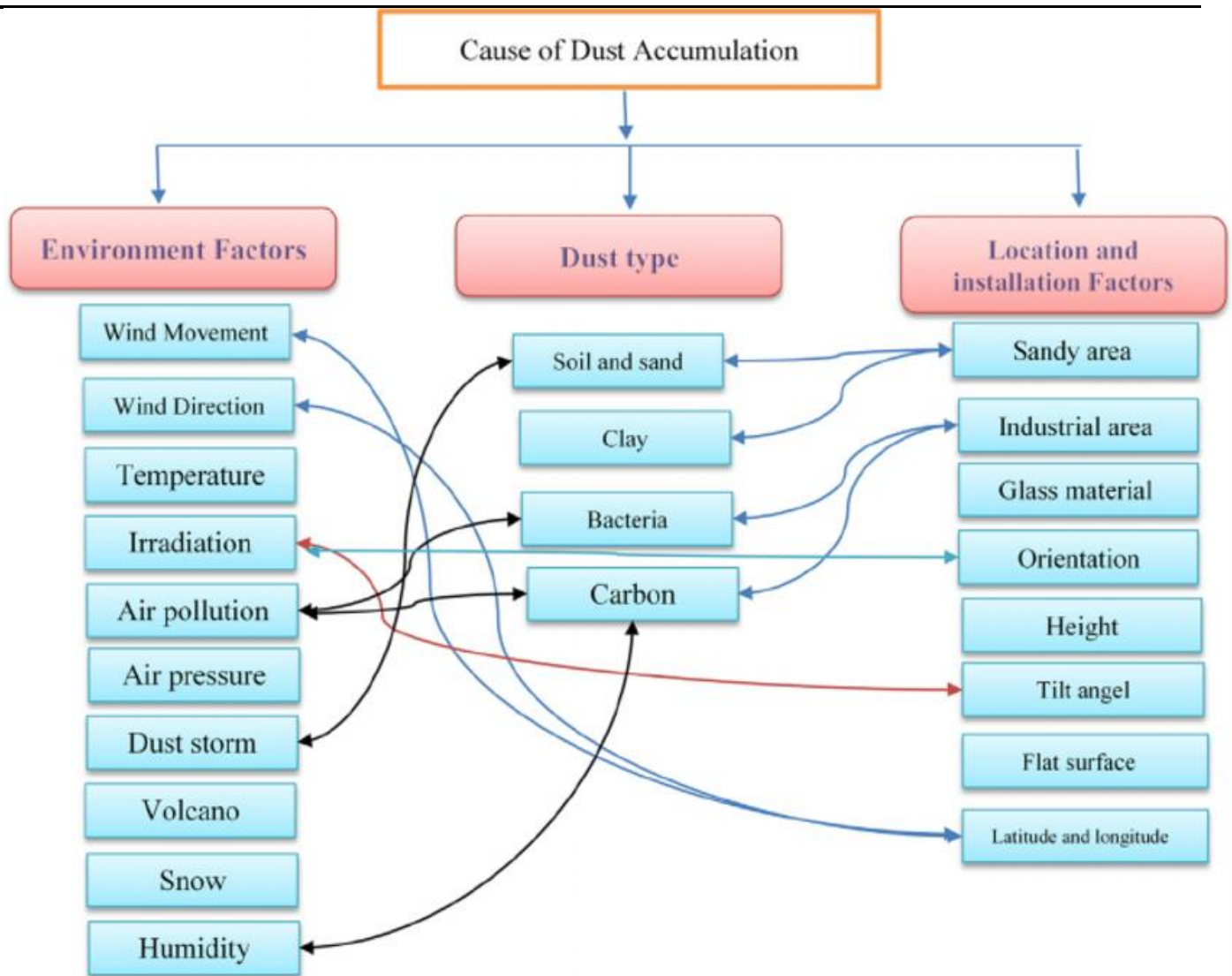

## II. LITERATURE SURVEY

### Technology of Solar Panel

Solar panels are devices that convert light into electricity. They are called solar after the sun because the sun is the most powerful source of the light available for use. They are sometimes called photovoltaic which means "light-electricity". Solar cells or PV cells rely on the photovoltaic effect to absorb the energy of the sun and cause current to flow oppositely charge layers. A solar panel is a collection of solar cells. Although each solar cell provides a relatively small amount of power, many solar cells spread over a large area can provide enough power to be useful. To get the most power, solar panels have to be pointed directly at the Sun. The development of solar cell technology begins with 1839 research of French physicist Antoine-Cesar Becquerel. He observed the photovoltaic effect while experimenting with a solid electrode in an electrolyte solution. After that he saw a voltage developed when light fell upon the electrode.

### Evolution of Solar Tracker

Since the sun moves across the sky throughout the day, in order to receive the best angle of exposure to sunlight for collection energy. A tracking mechanism is often incorporated into the solar arrays to keep the array pointed towards the sun. A solar tracker is a device onto which solar panels are fitted which tracks the motion of the sun across the sky ensuring that the maximum amount of sunlight strikes the panels throughout the day. When compare to the price of the PV solar panels, the cost of a solar tracker is relatively low. Most photovoltaic solar panels are fitted in a fixed location- for example on the sloping roof of a house, or on framework fixed to the ground. Since the sun moves across the sky though the day, this is far from an ideal solution. Solar panels are usually set up to be in full direct sunshine at the middle of the day facing South in the Northern Hemisphere, or North in the Southern Hemisphere. Therefore morning and evening sunlight hits the panels at an acute angle reducing the total amount of electricity which can be generated each day

### REVIEW OF ACCUMULATION OF DUST ON PV-PANEL

The studies that were examined all analyzed different aspects of soiling. One study, sponsored by the Power Light Corporation in Berkeley California, found a daily loss of 0.2% in power output. The report also noted a 7.5% to 12% efficiency increase due to rain.

The study also found that while rain is the primary cleaning agent for panels, it is not sufficient. The Boston University Study also reported the costs and benefits of three current methods of cleaning solar panels. These methods include natural cleaning through rain and snowfall, manual cleaning, and cleaning by an electrostatic system. In general, it was concluded that in order to maximize the cleaning effect of rain, the panels needed to have a glass shield and be oriented in the near vertical position. Manual cleaning by water and detergent was effective; however, it required costs set aside for labour (45.7% of the total cost) and fuel (20.5% of the total cost). An emerging technology, called an EDS, consists of interdigitated electrodes (made of indium oxide) in transparent dielectric film.

A standard "dirt" layer was chosen and was tested on three types of photovoltaic cells. monocrystalline, polycrystalline, and amorphous. The maximum reduction in electric production was 6% for monocrystalline and polycrystalline and 12% for amorphous. A research group at the University of Colorado studied the effect of dust on the transmission of light through glass panels.

### 2.1 Outcome of Literature Survey

By the literature survey we came to know that we can solve the problem of efficiency of tracking system and remove the dust particles in Panels. We can implement advanced form of Tracking system using Arduino and by the using of this method the over all efficiency will be increases and the cost of the electricity power will also reduced. We can give the electricity in future by use of this method and we get the most effective output in this method. By cleansing the dust present in the panels, the rise from the sun will get the more light energy.

### III. PROBLEM STATEMENT

A Solar panel (also solar module, photovoltaic module or photovoltaic panel) is a packaged. connected assembly of photovoltaic cells. The solar panel can be used as a component of a larger photovoltaic system to generate and supply electricity in commercial and residential applications thereby effectively producing renewable energy. Each panel is rated by its DC output power under standard test conditions, and typically ranges from 100 to 320 watts. Generally, solar panels are stationary and do not follow the movement of the sun and hence cannot obtain maximum sun light throughout the day. There is another major problem to check whether the storage battery of a solar power unit is being charged or not.

### PROJECT JUSTIFICATION

The project was undertaken to ensure the rays of the sun are falling perpendicularly on the solar panel to give it maximum solar energy. This is harnessed into electrical power. Maximum energy is obtained between 12pm to 2pm, with the peak being around midday. At this time, the sun is directly overhead. At the same time, the least energy will be required to move the panel, something that will further increase efficiency of the system. The project was designed to address the challenge of low power, accurate and economical microcontroller based tracking system which is implemented within the allocated time and with the available resources. It is supposed to track the sun's movement in the sky. In order to save power, it is supposed to sleep during the night by getting back into an horizontal position

### IV.OBJECTIVES

The objective of this project is to observe light energy from the sun with the help of Solar panel and Arduino board i.e., The Solar energy can observe completed in overall day time. The Solar panel will rotated with respect to Sun light by the help of sensors. And automatics Panel cleansing system.

The main objective of this project is

- To reduce the growing costs of electricity and environmental impact of fossil fuels.
- To increase the efficiency of the solar panel by using tracking system.
- To improve the absorption of light energy for better performance of solar panels by cleansing them automatically.

### V.METHODOLOGY

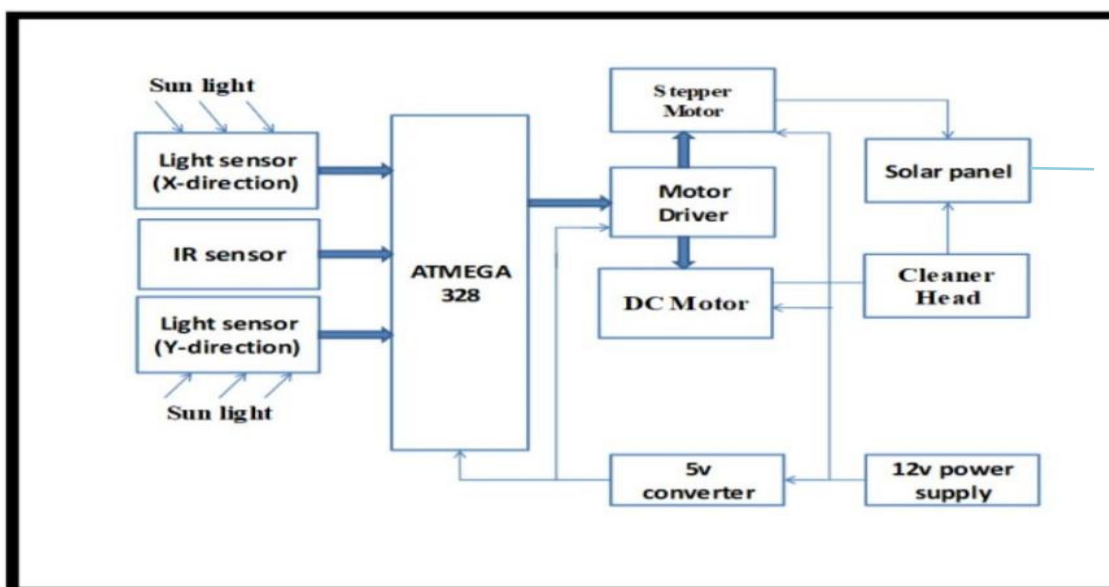

Fig.5:Block Diagram



- **Tracking mechanism**

A single axis tracking of the solar PV module is implemented along with the automated cleaning mechanism. For tracking the sun, the module is made to rotate 360 ° angle in a day, i.e. one rotation in 24 hours. The module starts its rotation from vertical position at the time of sunrise facing towards east (perpendicular to ground) This tracking mechanism is based on the angle of rotation of earth around its own axis. The time for rotation of earth around its own axis is 24 hours which is equal to the tracking time of this system. This system is always in synchronization with the rotation of earth without any extra component because, sunrise and goes on and on as earth rotates on its own axis. That is the reason this tracking system does not require any sensor or extra component for synchronization like any other tracking system which usually comprised of.

The system focuses on the controller design where the system is able to track the maximum intensity of Sunlight. When the intensity of Sunlight is decreasing, this system automatically changes its direction to get maximum intensity of Sunlight. LDR light detector acts as a sensor is used to trace the coordinate of the Sunlight by detecting brightness level of Sunlight. While to rotate the appropriate position of the panel, a DC motor is used. The system is controlled by a micro-controller as a main processor.

- **Cleaning mechanism**

The automated cleaning mechanism is implemented using brush, rod & sliding wheels as shown in the below figure. The brush is fitted in the rod. The rod is fitted with the wheels at both the ends, which are fitted in the channel in which they rotate. When panel comes in a vertical position at 6 am and 6 pm the brush fitted on the rod rotates on the panel from upwards direction due to gravity and cleans the panel two times in a day. In this way the cleaning mechanism works



The proposed Sun tracking and self-cleaning of solar PV modules are a complete product and can be implemented with any existing solar PV system.

## VI. ADVANTAGES/DISADVANTAGES/APPLICATIONS

### Advantages

- Maximum utilization of solar energy.
- Max. solar energy saving
- It is clean and emission free power production.
- External power supply is not required.
- Increase 40% efficiency of solar power plant.
- Once a solar panel is installed, the energy is produced at reduced costs.
- Whereas the reserves of oil of the world are estimated to be depleted in future, solar energy will last forever.
- It is pollution free.
- Solar cells are free of any noise. On the other hand, various machines used for pumping oil or for power generation are noisy.

### Disadvantages

- Initial investment is high
- Moving part will require regular maintenance.
- Uses a Lot of Space
- Solar panels can be costly to install resulting in a time lag of many years for savings on energy bills to match initial investments.

**Application**

- One of the wide applications for automation in the area of energy is suntracking system in which control theory is employed to drive the solar collector or concentrator towards sun in all times.
- International space station
- Solar cars
- Street lights

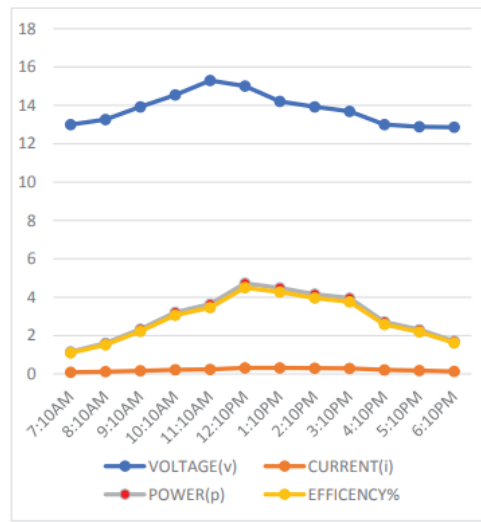

solar  
the  
  
and  
amp

Graph3- Output of dusty solar panel without sun tracking

**VII. RESULTS AND DISCUSSION**

This model is tested for 5 days in this method when tracking is done no cleaning system is present at that situation average current is 0.3 and efficiency is 35%. But when cleaning is done then efficiency increased to 94.95% and current produced to 0.95 amp. 12V, 30W panel Battery Capacity 100MAH

Sl. No.	Dust Percentage	Time taken to change the battery
1.	75%	2 hours, 30mins
2.	50%	2 hours, 10mins
3.	25%	1 hours, 50mins
4.	0%(no dust partials)	1 hours, 30mins

Table 1.1 Data for the time taken to change the battery

**CASE.1. OUTPUT OF CLEANED SOLAR PANEL WITH SUN TRACKING**

As shows the output of cleaned solar panel with sun tracking where tracking and cleaning both are done.

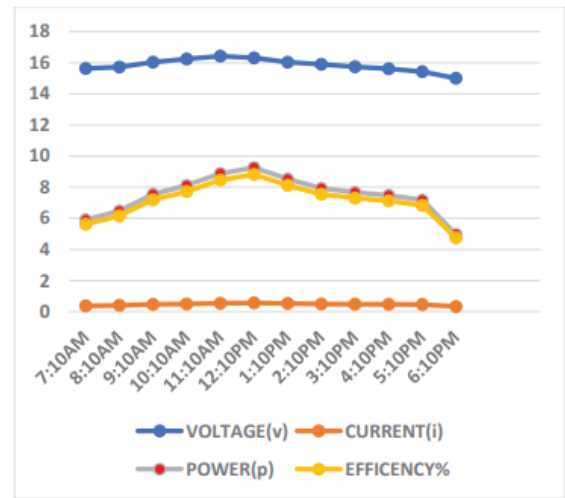
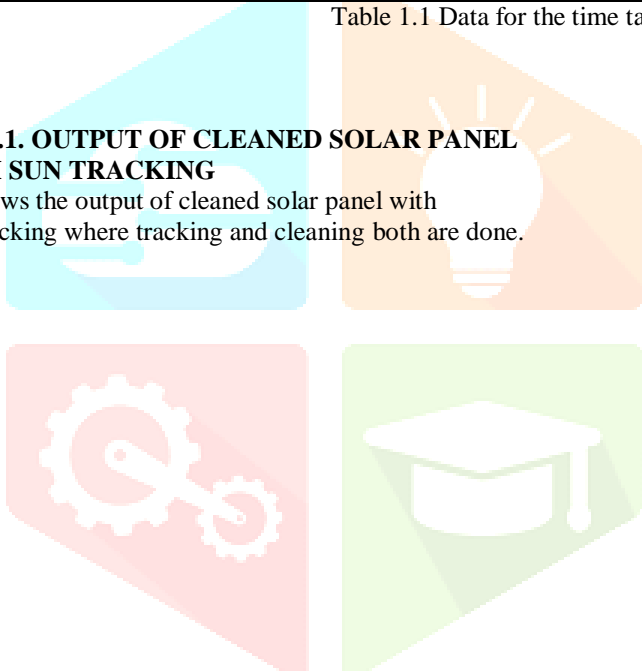

Graph1- Output of cleaned solar panel with sun tracking

**CASE 2:- OUTPUT OF CLEANED SOLAR PANEL WITHOUT SUN TRACKING**

As shows the output of cleaned solar panel without sun tracking where tracking are not done but cleaning are done

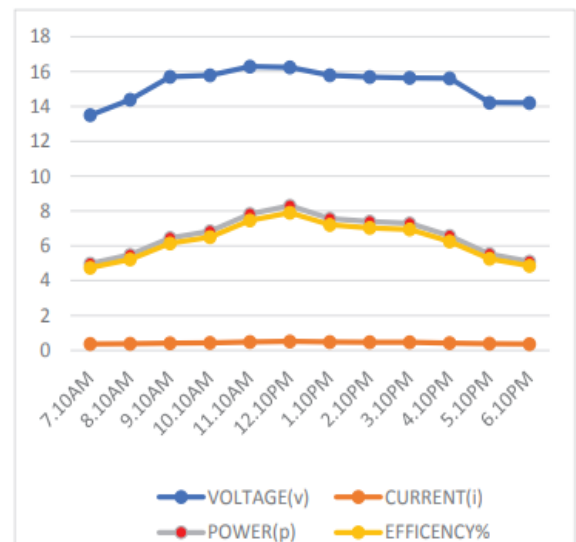

Graph 2- Output of cleaned solar panel without sun tracking

### CASE 3:- OUTPUT OF DUSTY SOLAR PANEL WITHOUT SUN TRACKING

As shows the output of dusty solar panel without sun tracking where tracking and cleaning both are not done

### CASE 4:- OUTPUT OF DUSTY SOLAR PANEL WITH SUN TRACKING

As shows the output of dusty solar panel with sun tracking where tracking are done but cleaning are not done

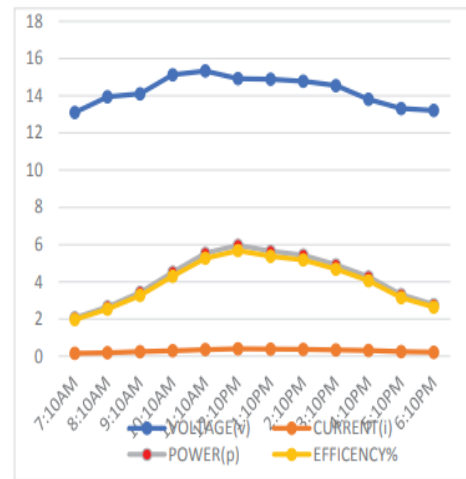

Graph4- Output dusty solar panel with sun tracking

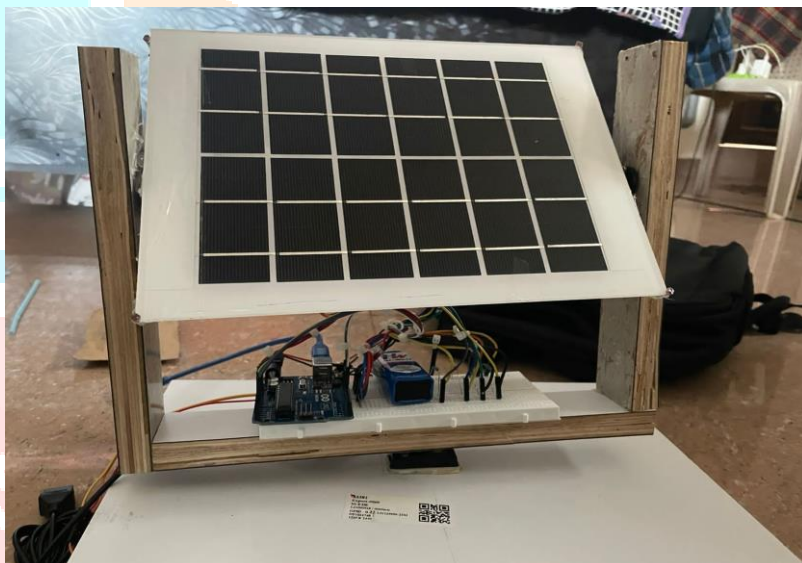

TRACKING SYSTEM

## AUTOMATIC SOLAR PANEL CLEANSING SYSTEM



### REFERENCES

- HOSSEIN MOUSAZADEH A, ALIREZA KEYHANI A, \*, ARZHANGJAVADI B, HOSSEIN MOBLI A, KAREN ABRINIA C, AHMAD SHARIFI B, "A REVIEW OF PRINCIPLE AND SUN TRACKING METHODS FOR MAXIMIZING SOLAR SYSTEMS OUTPUT", A DEPARTMENT OF AGRICULTURAL MACHINERY ENGINEERING, UNIVERSITY OF TEHRAN, IRAN
- TIAN PAU CHANG, "OUTPUT ENERGY OF A PHOTOVOLTAIC MODULE MOUNTED ON A SINGLE AXIS TRACKING SYSTEM", DEPARTMENT OF COMPUTER SCIENCE AND INFORMATION ENGINEERING, NANKAI UNIVERSITY OF TECHNOLOGY, NANTOU 542, TAIWAN
- CENTRAL ELECTRICITY REGULATORY COMMISSION [WWW.CERCIND.GOV.IN](http://www.cercind.gov.in), INDIA
- SOLARBUZZ, [WWW.SOLARBUZZ.COM](http://www.solarbuzz.com), PORTAL TO
- WORLD OF SOLAR ENERGY
- CEMIL SUNGUR, "SUN-TRACKING SYSTEM WITH PLC
- CONTROL FOR PHOTO-VOLTAIC PANELS",