



REVIEW ON DIFFERENT CHROMATOGRAPHY METHOD OF ANALYSIS

Suchitra V. Patil*, Shubhangi D. Shelke*, Vaishnavi V. Adake*, Manisha k. Pimpalkar*, Vaishnavi S. Mohite*

Department of Quality Assurance

Ashokrao Mane Collage of Pharmacy, Peth Vadgoan.

Maharashtra- India.

Abstract

Chromatography is derived from the Greek words “chroma” meaning color & “graphien” meaning to write. Chromatography is a separation method for separating constituents in a mixture. The mixture's components are disseminated in a liquid solution called the mobile phase, which binds it together by a structure comprising another substance called the stationary phase. Differential partitioning between the mobile and stationary phases is required for component separation. Chromatography analytical goal is to determine a sample's qualitative and quantitative chemical makeup, and its primary function is to purify and extract one or more components. This paper will go through the history and fundamentals of chromatography, as well as the major ideas of how to use it. In addition, for each chromatographic type, such as planar, TLC, gas, and liquid separation techniques, we will describe and focus on one application.

Keywords: Chromatographic types, resolution time, advantages, applications.

Introduction and some terminology -

Chromatography is a physical separation process in which a mixture of compounds can be separated, isolated, and purified into different molecules that have different distribution rates depending on 1. Solubility. 2. Affection (if polar or non-polar molecules) 3. Interaction with fixed material (the stationary phase, which we'll define later). The components in the mixture are dispersed between two phases: the stationary phase and the mobile phase, which moves at different speeds in a specific direction.

When Michael Tswett, a Russian botanist, used a column containing CaCO_3 and moved his mixture over it in 1901, he observed that chlorophyll pigments are split into several coloured components. Archer John Porter Martin and Richard Laurence Millington, who earned the Nobel Prize in Chemistry in 1952 for their work and efforts in developing many-based separation techniques such as partition, are known as the founders and fathers of chromatography (liquid-liquid chromatography).

The three basic aspects of a chromatographic separation technique are as follows: 1. The sample 2. The mobile phase 3. The phase of being stationary. The stationary phase is a solid substance in which a combination of components will be separated and isolated, and it can only be solid or liquid in nature. The mobile phase is a solid or liquid substance that transports a mixture of purified, isolated, and separated samples to the surface of the stationary phase. [5] Normal phase liquid chromatography (NPLC), in which the stationary phase is polar, is one of two types of chromatographic separation procedures. The first is reversed-phase liquid chromatography (RPLC), in which the stationary phase is non-polar, and the second is reversed-phase liquid chromatography (RPLC), in which the stationary phase is non-polar, & the mobile phase is polar. To perform a good chromatographic separator, & should choose the suitable parameter between the stationary and mobile phase.

Classification

The chromatographic method approach can be divided into three categories and summarised as follows:

- 1) The geometry of the stationary phase is important. e.g.- Planar and column chromatography,
- 2) Both the fixed and mobile phases' physical states are taken into account. e.g.-Gas and liquid chromatography
- 3) The relationship between the stationary and mobile phases is crucial. e.g.- Affinity, ion exchange, partition, adsorption, and size exclusion chromatography.

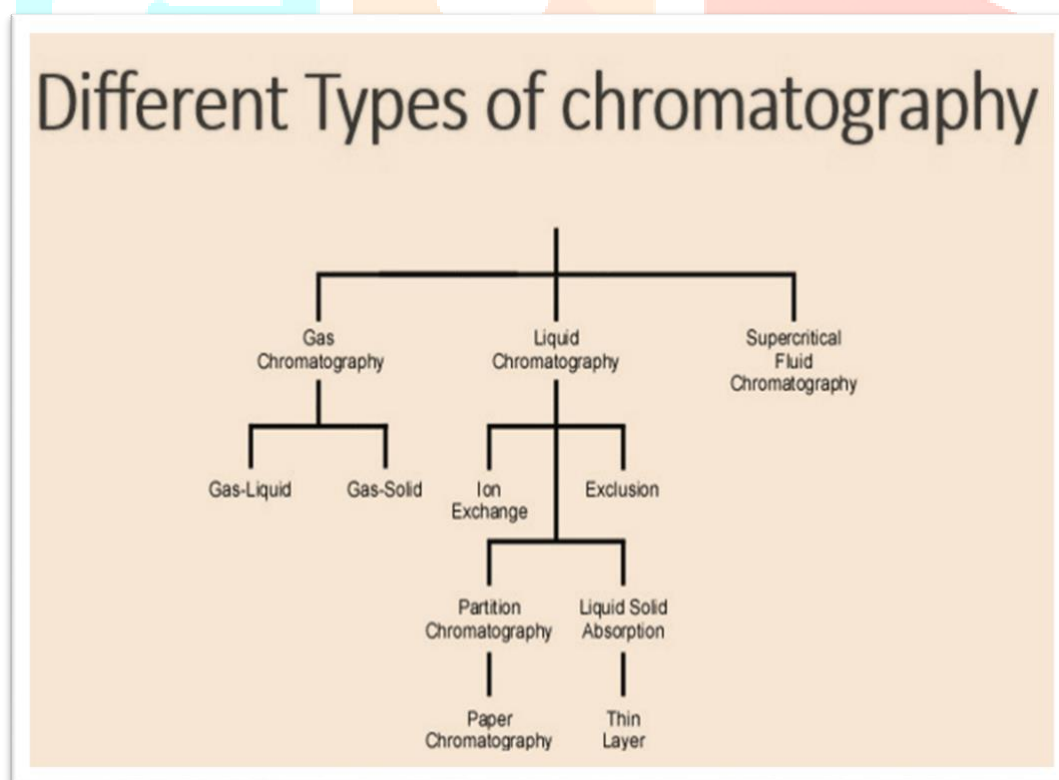

CLASSIFICATION OF CHROMATOGRAPHY

The commonly used chromatographic techniques among those include

➤ **PLANAR CHROMATOGRAPHY**

1. Paper chromatography
2. Thin layer chromatography (TLC)
3. High performance TLC

➤ **COLUMN CHROMATOGRAPHY**

1. High Performance Liquid Chromatography (HPLC)
2. Ultra -high performance chromatography (UHPC)
3. Gas chromatography (GC)
4. Ion-Exchange chromatography (IEC)
5. Size-exclusion chromatography (SEC)
6. Affinity chromatography (AC)

a. PLANAR CHROMATOGRAPHY

a. Paper chromatography (PC)

It is a method of separating a mixture of substances into distinct compounds by specially developed chromatographic paper as the stationary phase.

• **Principle –**

In paper chromatography, both partition and adsorption take place. The most common is partition chromatography, in which the chemicals are partitioned between two liquid phases, namely the moisture-containing cellulose layers in filter paper and the mobile phase. Because of the capillary action of the pores in the paper, the mobile phase separates the chemicals in the mixture.

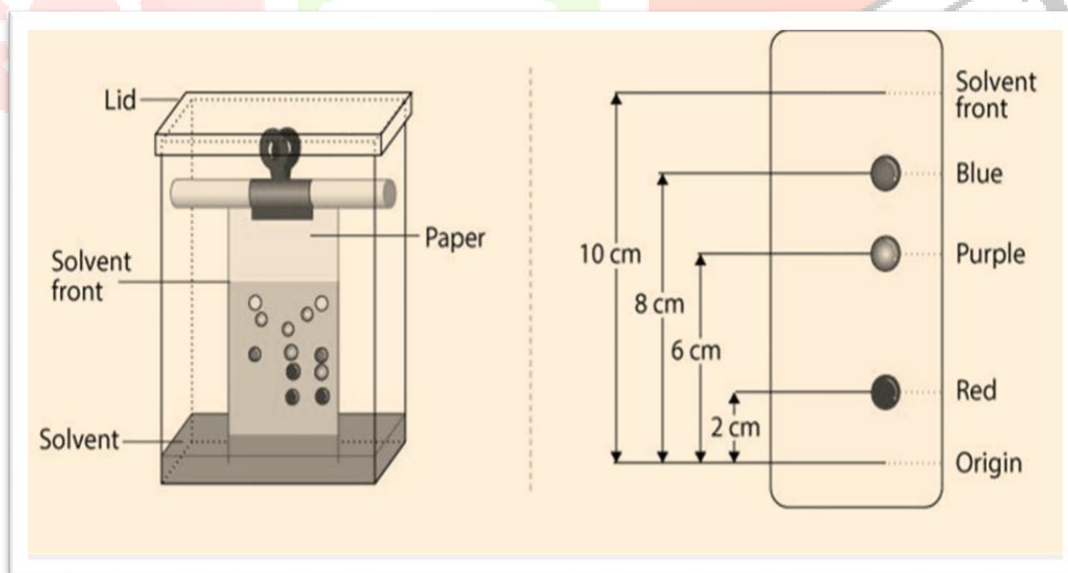

Paper chromatography (PC)

- **Components**

- A. Stationary phase and papers – Whatman filter paper of different grades, paper impregnated with silica or alumina.
- B. Mobile phase – pure solvents, mixture of solvents (methanol: water - 4:1)
- C. Sample applicator
- D. Chromatographic chamber.

- **Procedure-**

The sample combination is deposited on chromatography paper, which is then placed in the Edina solvent container. Individual components move a different amount of distance based on their affinity for the adsorbent and the solvent. Polar molecules bind to the filter paper and are transported over shorter distances, whereas non-polar molecules travel over longer distances. The "Rf value" is used to determine the extent of component displace. The Rf value is calculated by dividing the distance travelled by the component from the application point by the distance travelled by the solvent from the application location. The Rx value is the ratio of the sample's distance travelled to the standard's distance travelled. The Rx value is continually approaching one. The Rf number is always less than one, although the Rx value can be bigger. The solvent system and its composition, temperature, pH of the solution, paper and adsorbent quality, and the distance through which the solvent passes are all elements that influence the Rf value.

- **Detecting agent-**

The specks are detected using physical and chemical procedures for colorless substances. For fluorescent substances, physical approaches include the iodine chamber method and the UV chamber method. Ferric chloride, Ninhydrin in acetone, Dragendroff's reagents, 3,5 dinitro benzoic acid, and other chemical techniques These procedures, on the other hand, are not required for colored compounds.

- **Modes Paper chromatography**

The following approaches are available depending on how the chromatogram on the paper is created.

1. Ascending chromatography: As with conventional chromatography, the solvent moves upward on the paper. The beaker's solvent reservoir is located at the bottom.
2. Descending chromatography: The solvent reservoir is at the top in this case. In addition to capillary action, gravity (solvent flowing down the paper) aids the transport of the solvent.
3. Ascending-descending mode: A hybrid of the previous two techniques in which the solvent travels up and down the paper.
4. Circular/ Radial mode: In this mode, the solvent travels from the center of the circular chromatography paper to the periphery. For chromatogram development, the complete system is kept in a covered Petri dish. A centrally located wick directs the solvent onto the paper. The sample moves with the mobile phase, forming concentric rings of diverse chemicals.
5. Two-dimensional development: The samples are placed on one end of the rectangular paper and allowed to develop for the first time. By immersing the second chromatogram in mobile phase after the first, it is produced perpendicular to the first. As a result, the chromatogram develops in two directions at right angles.

- **Advantages**
 - Equipment that is simple and readily available □ separation efficacy is improved.
 - Separation of closely related homologous, isotopes, isomers, and extremely labile and reactive compounds is possible.

- **Application-**

Specifically designed for the separation of polar and non-polar substances in mixtures. Amino acids are used to separate pigments, dyes, and inks. The purpose of this test is to identify organic and other biological substances in urine. Hormones and medications can be determined using this method. Inorganic substances such as salts and complexes are evaluated. Medications can be determined using this method. Inorganic substances such as salts and complexes are evaluated.

b. Thin layer chromatography (TLC)

For the first time, Schraiber invented and used thin layer chromatography in 1939. Modern TLC is mostly used as a supplement to other column-based liquid chromatographic procedures in order to provide extra separation information (multi-modal separation techniques). TLC is critical in the early stages of drug development because knowledge of contaminants and degradation products in the drug substance and drug product is limited.

- **Principle-**

TLC is based on the adsorption concept. Adsorption and partition, or a combination of the two, are typically present. The elements that prefer the stationary phase travel more slowly, and vice versa.

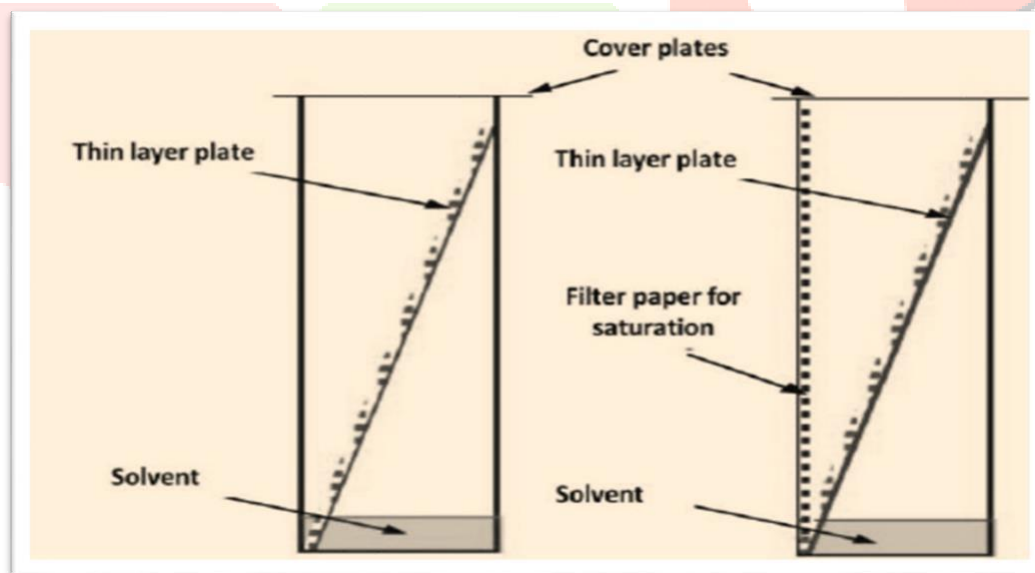

Thin layer plate development

- **Components=**

- TLC plates are chemically stable and inert plates used as a support for the stationary phase (glass, plastic, or aluminium support)
- TLC chambers are used to develop TLC plates and maintain a consistent environment.
- Stationary phase (solid phase) — thin layer of adsorbent (0.25 mm thick) coated on TLC plates.
- Filter paper – stops solvents from evaporating.
- A solvent or solvents make up the mobile phase.

- **Procedure**

The sample mixture dots are put near the bottom of the thin layer plate. Capillary action allows solvents to percolate up the plate. The chamber is filled with solvent vapour to prevent the solvent from evaporating off the plate surface and to control the retention mechanism by surface deactivation. The plate is then placed in the chamber without the sample location being dipped. A heavily adsorbed element will travel more slowly. The Rf value is used to depict the results, just like in paper chromatography.

- **Factors that influence efficacy =**

Several factors influence the efficiency of chromatographic separation, including the adsorbent's selectivity for the chemicals being separated and its adsorbing power. Alumina (Al₂O₃), charcoal ©, florisil [MgO/SiO₂ (anhydrous)], and silica gel are some of the most often used adsorbents in decreasing order of their adsorptive capacity (SiO₂).

- **Advantages**

1. High sample throughput technology that is simple, rapid, and economical
2. A large number of movable phases
3. A minimum amount of sample preparation
4. Several samples can be run at the same time with a modest amount of mobile phase.
5. In analytical laboratories with minimal resources, this method is utilised.

- I. **Applications**

- I. It is employed in the separation of all types of natural goods. Acids, alcohols, amines, macromolecules such as amino acids and proteins, and so on.
- II. Frequently used in the identification and purification of materials.
- III. To monitor the effectiveness of other separation methods
- IV. To examine the reaction process by assessing intermediates, reaction course, and so on.
- V. Inorganic ion separation - used to separate cationic and anionic chemicals
- VI. Vitamin separation – Vitamin E, Vitamin D₃
- VII. A quantitative analysis of vitamin A

- c. **High performance thin layer chromatography**

It's a more advanced type of TLC with a quick separation approach that can separate a wide range of samples and just takes a few minutes to analyse the complex or crude sample clean-up.

- Key characteristics**

- I. Simultaneous sample and standard processing improve analytical precision and accuracy, reducing the need for an internal standard.
- II. Reduced analysis time and cost per analysis, as well as lower maintenance costs.
- III. Simple sample preparation - work with a variety of samples.
- IV. There is no preceding solvent treatment, such as filtration or degassing. V. Low per-sample mobile phase usage.
- VI. No contamination due to contamination from prior analyses — each analysis uses fresh stationary and mobile phases.

- **Procedure**

With the help of an applicator machine, prepared sample and standards are applied to the pre-washed and pre-conditioned chromatographic layer. The sample is then placed in a chromatographic chamber with mobile phase to separate. Detectors or scanners are used to read the produced chromatogram.

- **Precondition**

The equilibrium of the solvent vapour and the plate will be different from the equilibrium of the solvent and the plate. The developing solvent is present in a separate reservoir, comparable to normal development. The plate is placed in the enclosure for a few minutes to achieve equilibrium with the solvent vapour. The plate is then placed in the developing solvent, with the separation being processed in the developing solvent. The plate is placed in the enclosure for a few minutes to achieve equilibrium with the solvent vapour. The plate is then inserted in this manner, dipping its end into the developing solvent, and the separation is carried out as usual. The apparatus for pre-equilibrium of a thin layer plate is shown in Figure, as well as the differences between the two TLCs. Pre-saturation of the TLC plate increases the velocity of the solvent front compared to the unsaturated plate, and separated components are much closer to the solvent front in the unsaturated plate,

- **Applications**

- I. An established for determining and purifying various medicines in the pharmaceutical business.
- II. Food and drug analysis includes herbal medicine quantification, vitamin analysis, water soluble food dye analysis, and pesticide analysis in fruits, vegetables, and other foods.
- III. Fingerprint analysis, detection of misuse substances, poisons, adulterations, chemical weapons, and illicit drugs are all forensic services.
- IV. Environmental analysis and cosmetology

B) CHROMATOGRAPHY IN COLUMNS

Column chromatography achieves more resolution than other purification procedures, making it more efficient in terms of protein purification. The stationary phase is packed in a glass or metal column. The stationary phase is smeared as a thin film on the interior wall of the column or deposited on small discrete particles and packed into the column. The eluent is passed through the column either by a pumping mechanism or by applying gas pressure after the analytes have been added. As the eluent runs through the column, the analytes segregate based on their distribution coefficients. As they depart the column, they emerge separately in the eluate. Between the column and the detection system. The monitoring is done with a detection system installed between the column and the fraction collector.

Elution of analytes retained by the stationary phase with the mobile phase can be accomplished using either high or low pressure. In general, chromatographic procedures carried out at pressures of less than 5, between 6 and 50, and greater than 50 bars are referred to as low pressure, medium pressure, and high pressure (1 bar = 14.5 pounds per square inch). The eluent should flow through the column at a consistent rate.

- **Components-**

The following components make up a typical column chromatographic system with a gas or liquid mobile phase:

- A stationary phase - as necessary for analyte separation
- A column • Microbore (tubular) type: stationary phase is coated directly on the interior wall of the column (PLOT – porous layer open tubular column, SCOT – support coated open tubular column, WCOT – wall coated open tubular column)

CHROMATOGRAM

- Complement the stationary phase with a mobile phase and delivery system to distinguish between the sample analytes and deliver a steady rate of flow into the column.
- An injector mechanism is used to consistently deliver test samples to the top of the column.
- A detector as well as a chart recorder – Each analyte is represented by a peak on the chart recorder.
- A fraction collector is used to collect the separated analytes for biochemical research. The analyte development and elution modes can be used to divide column chromatographic processes.

• Development of analytes

- I. Zonal development - analytes in the sample are segregated between the stationary and mobile phases based on their distribution coefficients.
- II. Analytes in the sample are separated based on their affinity for the stationary phase (displacement or affinity development).

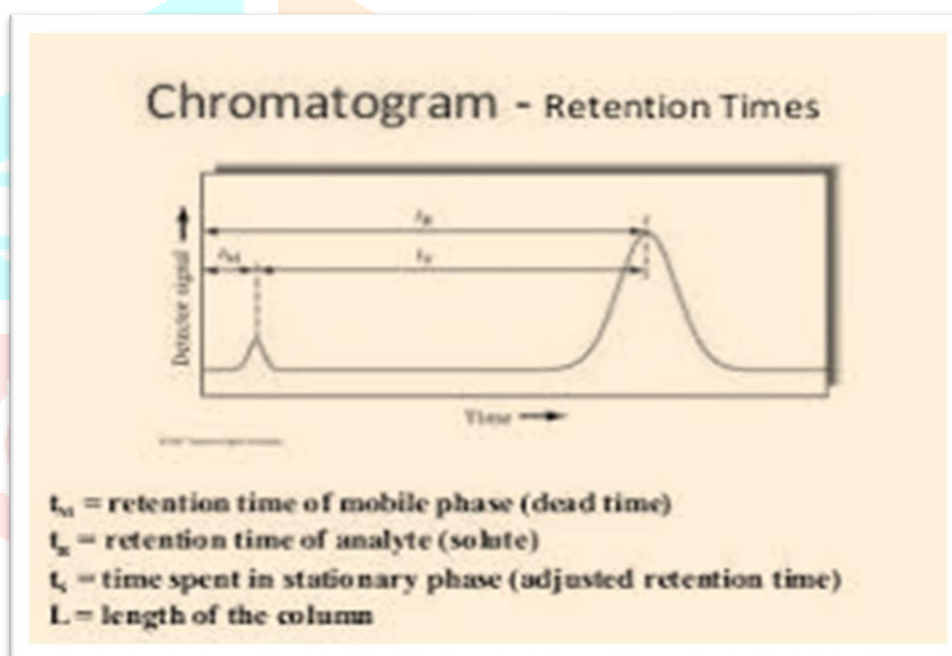

Graph of retention time

Retention time-

It is the time elapsed between sample introduction (beginning of the chromatogram) and the maximum signal of the given compound at the detector.

The retention time factor is calculated by multiplying the distribution constant by the volume of stationary phase in the column and dividing by the volume of mobile phase in the column.

• Elution

- I. Isocratic elution - The mobile phase's composition remains constant. For example, GC and various types of HPLC
- II. Gradient elution - To promote separation, the mobile phase's composition (pH, salt concentration, or polarity) is altered continuously or in a stepwise way. HPLC,

In any chromatographic separation, two processes work together to influence the behaviour of each analyte.

- 1) Adsorption, partition, ion exchange, and molecular exclusion are the basic processes. These describe how each analyte interacts with the stationary
- 2) Diffusion is a secondary process (oppose the separation). The outcome is a broadening and

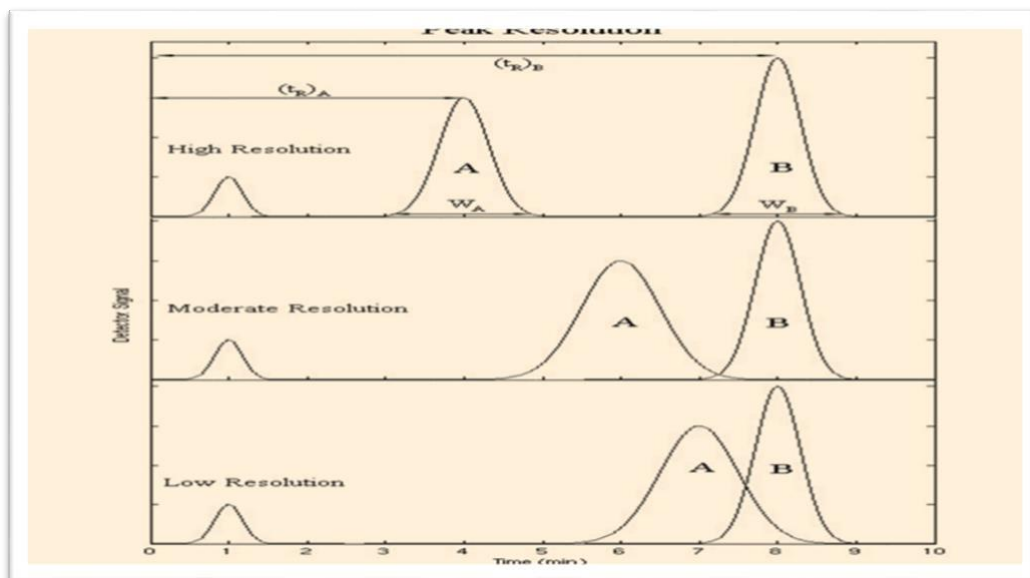

Peak of the retention time

A) High performance Liquid chromatography with (HPLC)

One of the most often used analytical procedures is high-performance liquid chromatography (HPLC). Due to the physical features of HPLC columns, high pressure should be used to ensure eluent flow through the column. The approach was previously known as high pressure chromatography.

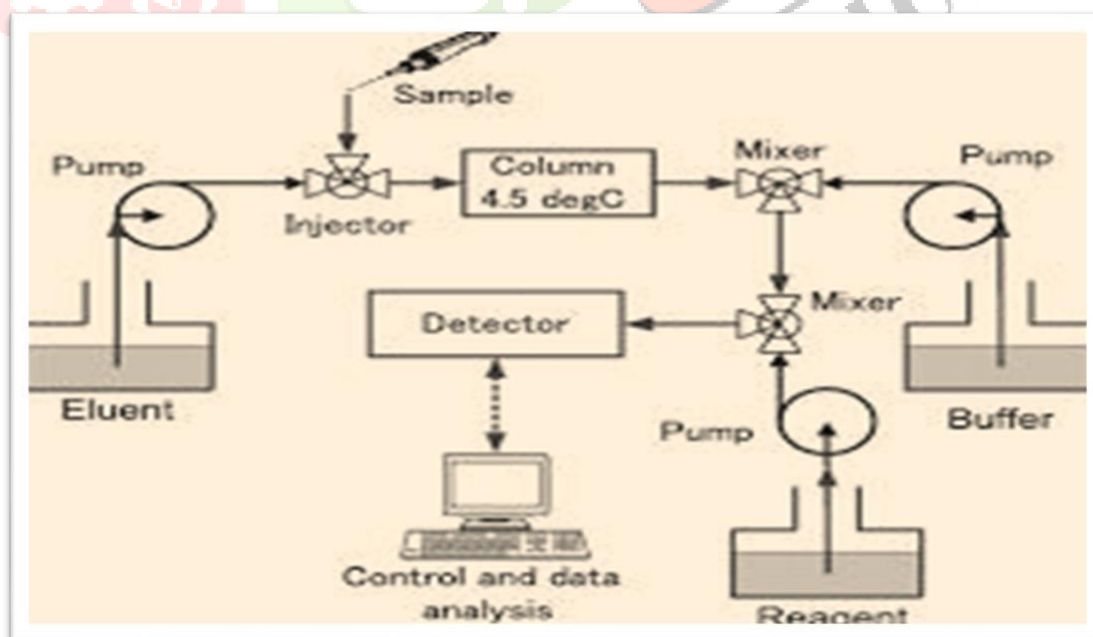

Schematic representation of an HPLC system

- **Chromatographic analysis**

- I. The number of components in a sample is determined by
- II. the number of peaks obtained. The area under the peaks determines the amount of a given component in a sample.
- III. The retention time aids in component identification

The basis for HPLC is a small particle size stationary phase that improves separation efficiency. This is because the solute may equilibrate between the two phases more quickly. Low-pressure liquid chromatography uses a larger particle size stationary phase, and the eluent is either gravity-fed or pumped through the column by a peristaltic pump (low pressure pump). It is less expensive to operate, but it lacks the high resolution. Surface area increases as the size of stationary phase particles decreases, and therefore the number of plates increases, resulting in higher resolution. However, due to greater capillary action, resistance to the flow of the mobile phase increases with smaller particle sizes. Backpressure is created by this resistance, which slows the flow rate.

- **Components of HPLC system**

- I. Mobile phase**

HPLC equipment can handle up to four distinct eluents. Eluents of high purity should be utilised. A single eluent or two or more eluents premixed in set proportions can be created with a single pump in isocratic elution, whereas separate pumps are employed to supply two eluents in proportions predetermined by a gradient programmer in gradient elution. Eluent, which is effective in normal phase HPLC, is ineffective in reversed phase HPLC, and vice versa.

- II. System of buffers**

- ✦ **Formulation**

The composition of the elution buffer should not affect the resolution.

- ✦ **Elution column**

For separation of sample containing the components, suitable eluent held in a buffer reservoir is circulated through the column at a constant uniform rate. The sample is evenly distributed over the stationary phase bed.

- ✦ **Degassers and filters**

To eliminate dust particles, the membrane filter is required. Warming, strong swirling with a magnetic stirrer, vacuum, ultra-sonication, and bubbling helium gas through the eluent reservoir are all methods for degassing

- ✦ **System for pumping**

One of the most essential elements of HPLC systems is the availability of special pumps for the transfer of eluent. The pump's job is to drive a mobile phase at a certain flow rate (mL/min) through the liquid chromatograph. These pumps may produce pressures between 6000 and 9000 psi (400 and 600 bar). In HPLC, standard flow rates range from 1 to 2 mL/min. Main features of a good pumping system include pressure capability of at least 50 MPa and no pulses (e. g. cyclical variations in pressure).

✦ Sample presenter

A loop injector is the most prevalent form of sample introduction. It is made up of a small metal loop that can be filled with the sample [5–20 microliters (L)]. The eluent is channelled through the loop and the sample by adjusting the position of the valve. The eluent is cancelled through the loop and the sample is flushed onto the column by altering the position of the valve. Manual HPLC injectors are available, but in the case of a large number of samples, an auto sampler is more practical.

✦ The columns

In the separation process, the column is sometimes referred to as the "heart of chromatography," and the availability of stable, high-performance stationary phases and columns is crucial for the development of repeatable and robust procedures. Because of its consistent strength and stiffness, relative inertness, and ability to be chemically changed, silica is the most often used column packing material. To improve the morphological and physico-chemical properties of these silica materials, numerous adjustments have been made. Microspheres of fully porous silica [octadecyl-silica (ODS-silica), which comprises to improve the morphological and physico-chemical properties of these silica materials, numerous adjustments have been made. Fully porous silicon microspheres [octadecyl-silica (ODS-silica), which has a C18 covering] are the most often employed in HPLC columns because they provide numerous essential advantages such as high sample loading, durability, and commercial availability.

• Application

HPLC is the best method for separating non-volatile and thermally unstable chemical and biological substances,

- I. such as Aspirin, ibuprofen, and acetaminophen are examples of pharmaceutical
- II. Salts such as sodium chloride, potassium phosphate, and others.
- III. Egg white or blood protein are examples of proteins.
- IV. Polymers are organic compounds (e.g., polystyrene, polyethylene).
- V. Other hydrocarbons and motor oil
- VI. Ginseng, herbal medications, and plant extracts are among the many natural goods available.
- VII. Enzymes and thermally unstable chemicals like trinitrotoluene (TNT).
- VIII. Pharmaceutical production, quality assurance, diagnostics, toxicology, research, and other laboratories all use HPLC devices.

B. Ultra - high performance Chromatography (UHPC)

The Ultra high performance (UHPC) is a revolutionary building material having mechanical and durability features that can lead to cost-effective construction by reducing the cross sections of structural components, resulting in material savings, as well as cheaper installation and labour costs (Tang 2004). Because of its relatively expensive initial cost, UHPC's usage in the building sector has been limited. However, current research and investigations are closing knowledge gaps so that novel UHPC can be launched at a lower starting cost.

- **UHPC benefits include:**
 1. simplified construction techniques
 2. Construction speed
 3. Increased longevity
 4. Lower maintenance costs
 5. Lower out-of-service time
 6. Minimal disruption
 7. Smaller and more complex elements
 8. Longer lifespan
 9. Enhanced resiliency

C. Gas Chromatography (GC)

Gas chromatography is a highly complex analytical process that uses a gaseous mobile phase.

- **Types**
 - a) Gas-solid chromatography (solid stationary phase) – works on the basis of adsorption – not widely used due to a lack of stationary phases
 - b) Gas-liquid chromatography (the stationary phase is a liquid that is fixed or immobilised on a support material) – works on the partition and adsorption principles.

- **Components**

Carrier gas is delivered in a high-pressure cylinder, complete with pressure regulators and flow metres. He (common), N₂, H₂, and argon-methane are examples of carrier gases. (He is selected because of his excellent thermal conductivity.) When a considerable amount of carrier gas is used, N₂ is desirable.

The packed column should have a flow rate of 25 to 150 mL/min, whereas the open tubular column should have a flow rate of 1 to 25 mL/min. Carrier gas from the tank travels through a toggle valve, a flow metre, and a pressure regulator. Capillary restrictors, a pressure gauge, and a 1000mL/min flow rate (1-4 atm). A flow rate of 25 to 150 mL/min is preferred for the packed column whereas a flow rate of 1 to 25 mL/min for the open tubular column. Pressure regulators: Carrier gas from the tank passes through a toggle valve, a flow meter, (1-1000mL/min) capillary restrictors, and a pressure gauge (1-4 atm). Flow rate is adjusted by means of a needle valve mounted on the base of the flow meter and controlled by capillary restrictors

- **System for injecting samples**

A microsyringe is used to inject a liquid sample. To function properly, the injector must be kept at a high temperature. To facilitate analysis, move to the vapour phase. The sample is injected directly into a heated port with a temperature that is greater than the oven. For a packed column and a capillary column, the injection volumes are 1-20 L and 10-3 L, respectively.

The separation column, which is made of metals bent in a U shape or coiled into an open spiral or a flat pancake shape, is the heart of gas chromatography. Up to a point, copper is beneficial.

2500C. Various column sizes are employed, depending on the requirements. 2-50 m stainless steel/glass/Teflon coiled column Column types based on their function

1. The analytic column 3-6 mm diameter, length 1-1.5 metres
2. The preparatory column 6-9mm diameter, 3-6 metres long

- **Column types based on their nature:**

- I. Adsorption and partition in a packed column
- II. Capillary, open tubular, or Golay column
- III. Wall coated open tubular (WCOT) – divider
- IV. Partition SCOT (sorbent coated open tubular)
- V. absorption PCOT (porous layer open tubular)
- VI. Detection device
- VII. a tape recorder
- VIII. Columns and detectors have their own thermostat compartments (Oven: 0400 °C).

- **Procedure**

The vaporised components of the mixture adhere strongly or weakly to the stationary phase in the column. The mobile phase transports the weakly bound component to the column's output first. As a result, the components will be separated based on their boiling point, molecular weight, polarity, and capacity to hydrogen bond to the stationary phase. The magnitude of the output is determined by the partial pressure of the solute in the gas and the sensitivity of the detector to the sample. The output is simply a chromatogram of the amount of solute exiting the column as a function of time.

- **Advantages**

- I. Because of its great resolution power, complex mixes can be resolved into their constituents.
- II. TCD has a very high sensitivity.
- III. It is a micro technique, even a little sample size is adequate.
- IV. Gas as a moving phase allows for quick investigation and swift equilibrium.
- V. Precision and accuracy are relatively good.
- VI. Analyses, both qualitative and quantitative

- **Applications**

- I. Rt and RV are used for identification and separation in quality management.
- II. Purity control, environmental, and pharmaceutical analysis - the standard and sample chromatograms are compared.
- III. Quantitative examination of primary and trace components - Each component's peak area or peak height must be measured.

D) Ion exchange chromatography (IEC)

A method for separating ions and polar molecules according to their charge. Cation- or anion exchangers in the stationary phase. - Zeolites (aluminum-sodium silicate) (cation exchanger)

- Resins for cation exchange, - resins for anion exchange

Aqueous solution of ionic substances in the mobile phase (e.g., phosphate, formate, etc.)

The ions in the mixture have different affinity for the ion-exchanger.



The selectivity of ions is determined by their geometrical size and electrical charge.

- **Applications**

Analysis of amino acid combinations (amino acid analyzer) Charged compounds such as anions, cations, amino acids, peptides, and proteins are separated.

e). Chromatography by size-exclusion (SEC)

SEC, also known as gel permeation chromatography (GPC) or gel filtration chromatography, separates molecules based on their ability to pass through a sieve-like structure called the stationary phase. Molecules bigger than the typical pore size are the first to be excluded, with no retention time

- **There are two modes-**

- non-aqueous SEC (also known as GPC or Gel Permeation Chromatography)
- aqueous SEC (also known as Gel Filtration Chromatography (GFC))

- **Applications**

- I. Separations of biological macromolecules in preparation
- II. Synthetic organic polymer purification
- III. Purified protein tertiary and quaternary structure determination

f). Chromatography of affinity (AC)

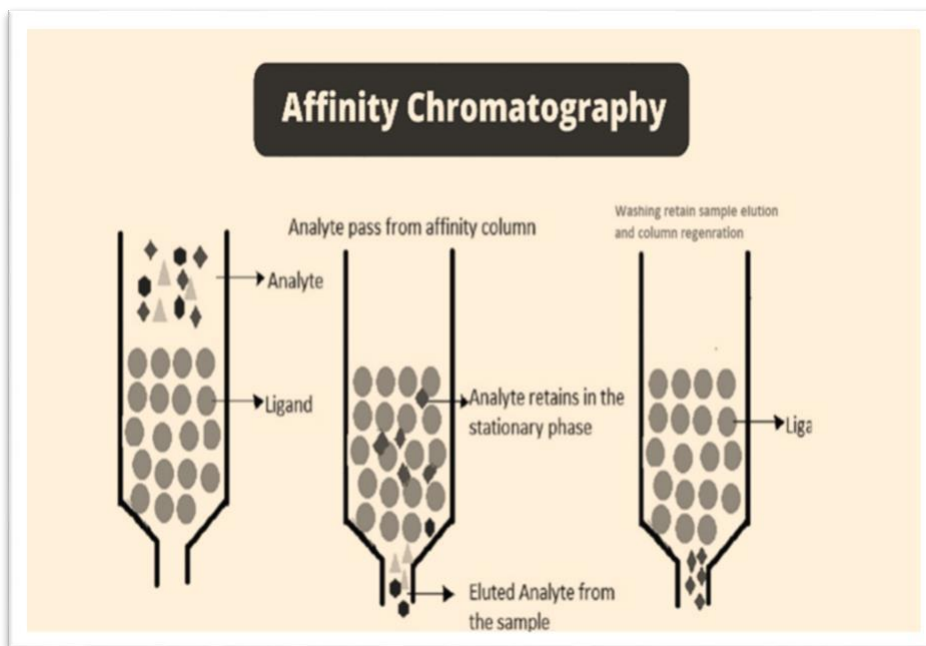

Diagram of affinity chromatography

It's a new type of chromatography that makes use of high specific contacts (non-covalent interactions between an analyte and an affinity ligand that's covalently linked (immobilized) to the stationary phase). This is the most discerning kind.

E.g. Antigen by Antibody, Enzyme by Inhibitor/Substrate/Cofactor/coenzyme,

• Applications

- I. Protein purification is a process that involves separating proteins from their natural environments (based on interaction between a protein of interest, and a ligand immobilised on a stationary phase substrate or product analogue)
- II. Biomolecules are separated depending on their relative affinity for metals such as Zn, Cu, Fe, and others. (Chromatography of Immobilized Metal Affinity) (IMAC).

• chromatography in supercritical fluid (SFC)

SFC is a gas chromatography/liquid chromatography hybrid. I. Carbon dioxide is the mobile phase.

- II. To separate molecules that are thermally labile
- III. Chiral compound separation

• chromatography on a chiral column

- A. Chiral inactive phase
- B. For enantiomer or racemic mixture separation

• CONCLUSION

Though there are many different types of analytical techniques, as mentioned above, the best method for a specific pharmaceutical must be chosen individually. Even in the early stages of drug development, researchers look for the most specific or "gold standard" approach for a pharmacological analyte. As a result, the development of new bio-analytical techniques (including novel chromatographic techniques) as well as developments in existing processes are critical for the creation of a successful drug.

REFERENCES

1. Ravali R, Phaneendra M, Bhanu JK, Ramya SL, Sushma K. Recent Trends in Analytical Techniques for the Development of Pharmaceutical Drugs. *J Bioanal Biomed.*, 2011; R1: 002.
2. Skoog DA, Holler FJ, Crouch SR. Principles of Instrumental Analysis. 6th ed. California: Thomson, Brooks/Cole Publishing Co., 2007.
3. Chavan M, Sutar M, Deshmukh S. Significance of various chromatographic techniques in drug discovery and development. *IJRPC.*, 2013; 3: 282-9.
4. Lee DC, Webb ML. Pharmaceutical analysis. Canada: Blackwell Publishing Ltd., 2003.
5. Scott RPW. Principles and practice of chromatography. Canada: Library for Science., 2003.
6. Dhaneshwar SR, Salunkhe JV, Bhusari VK. Validated HPTLC Method for Simultaneous Estimation of Metformin Hydrochloride, Atorvastatin and Glimepiride in Bulk Drug and Formulation. *J Anal Bioanal Tech.*, 2010; 1: 109
7. Chatwal GR, Anand SK. Instrumental Methods of Chemical Analysis. 5th ed. Mumbai: Himalaya Publishing House Pvt. Ltd., 2012.
8. Siddiqui MR, AlOthman ZA, Rahman N. Analytical techniques in pharmaceutical analysis: A review. *Arab J Chem.*, 2013; 6: 124-36.
9. Bonfilio R, De Araujo MB, Salgado HRN. Recent applications of analytical techniques for quantitative pharmaceutical analysis: a review. *Wseas Trans Biol Biomed.*, 2010; 7: 41-68.
10. Andol HC, Purohit VK. High Performance Thin Layer Chromatography (HPTLC): A modern analytical tool for biological analysis. *Nat Sci.*, 2010; 8: 58-61.
11. Attimarad M, Mueen Ahmed KK, Aldhubaib BE, Harsha S. High-performance thin layer chromatography: A powerful analytical technique in pharmaceutical drug discovery. *Pharm Methods.*, 2011; 2: 71-5.
12. Chakravarti B, Mallik B, Chakravarti DN. Column Chromatography. *Curr Protoc Essent Lab Tech.*, 2008; 6-2.
13. Wilson K, Walker JM. Principles and techniques of biochemistry and molecular biology. 7th ed. New York: Cambridge University Press., 2010.
14. Kenndler E. Introduction to chromatography. Institute for Analytical Chemistry, University of Vienna., 2004 Jan; 19.
15. Chromatography-Modern Chemical techniques. London: The Royal Society of Chemistry, Unilever.,

16. Bak I. Modern analytical techniques in the pharmaceutical and bioanalysis. Medical and Health Science Center, University of Debrecen., 2011 Oct 31.
17. Grob RL, Barry EF. Modern Practice of Gas Chromatography. 4th ed. New Jersey: John Wiley & Sons Inc., 2004.
18. Sliepcevich A, Gelosa D. Gas and liquid chromatography. In: Sergio Carra, editor. Fundamentals of Chemistry. Italy: UNESCO-EOLLS., 2009.
19. Ballance R. Advanced instrumental analysis. In: Bartram J, Ballance R, editors. Water Quality Monitoring - A Practical Guide to the Design and Implementation of Freshwater Quality Studies and Monitoring Programmes. Geneva: UNEP/WHO., 1996.

