



SMART HEAD BAND FOR STROKE PATIENTS

¹Dr.J.Sofia Bobby, ²Annapoorani C L, ³Divya P S, ⁴Malini S, ⁵Muzhumathi,

¹Associate Professor, ²Assistant Professor, ^{3, 4, 5} Student

¹Department of Biomedical Engineering,

¹Jerusalem College of Engineering, Chennai, Tamil Nadu.

Abstract: The main objective of this project work is to determine the oxygen saturation level in the cerebrum. Smart head band is based on infra-red used during the preoperative period of cardiovascular operations and on stroke patients. It is a non-invasive technology that can monitor the regional oxygen saturation of the frontal cortex. This proposed method helps us to monitor health status of the patient's oxygen saturation level especially for stroke and cardiac patients. It provides continuous information about brain oxygenation. This review focuses on the clinical validity and applicability of this monitor for cardiac surgical patients'. This method is designed as a wearable device in the form of Head band.

Index Terms - Oxygen saturation; Arduino; Noninvasive System; Stroke and cardiac patient

I. INTRODUCTION

Worldwide Stroke is the second leading cause of death and the third leading causes of disability globally. 70% of stroke and 87% of both stroke related deaths and disabilities adjusted life year occur in low and middle income countries. Stroke, the sudden death of some brain cells due to lack of oxygen when the blood flow to the brain is lost by blockage or rupture of an artery to the brain, is also a leading cause of dementia and depression. Treatment for stroke depends on whether the patient is diagnosed with an ischemic or hemorrhagic stroke. In either case the person must get to a hospital immediately for the treatments to work. Ischemic stroke treatment can be divided into emergency treatments to reverse a blockage and preventive treatments to prevent stroke.

1.1. Emergency procedures

When an individual is brought to the emergency room with an apparent stroke, the doctor will learn as much about the patient symptoms, current and previous medical problems, current medications and family history. The doctor also will perform a physical exam. If the patient can't communicate, a family member or friend will be asked to provide this information. Diagnostic tests are used to help the doctors determine what the cause is and how to treat the stroke. The various diagnosis procedures for stroke include.

1.2 Preventive procedures

- Blood thinners
- Angioplasty/stents
- Carotid endarterectomy

1.3 Structure of the Brain

According to hypothesis, particularly prefrontal lobe is associated with the deception. The frontal lobe, located at the front of the brain is the largest of the four major lobes of the cerebral cortex in the mammalian brain. The frontal lobe is located at the front of each cerebral hemisphere.

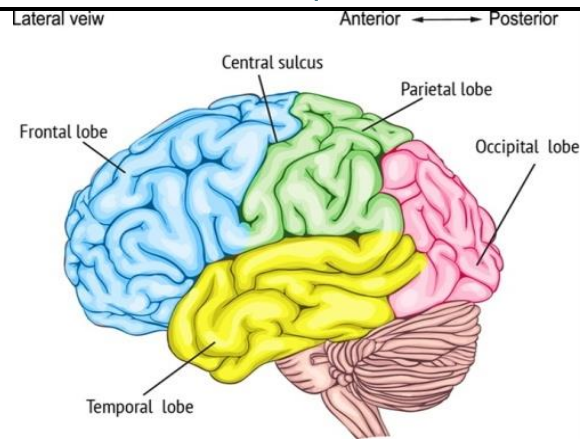

Fig 1.1 Parts of human brain (Courtesy: Wikipedia)

1.4 Stroke

Stroke is a sudden interruption of the blood supply to the brain. Most strokes are caused by an abrupt blockage of an artery (Ischemic Stroke). Other strokes are caused by bleeding into brain tissue when a blood vessel bursts (Hemorrhagic stroke). The signs and symptoms of a stroke depend on which region of the brain is affected and to what degree. Strokes may cause sudden weakness, loss of sensation, or difficulty with speaking, seeing or walking. Since different parts of the brain control different areas and functions, it is usually the area immediately surrounding the stroke that is affected. Hemorrhagic strokes have a much higher death rate than ischemic strokes.

1.5 Treatment

After emergency treatment, you'll be closely monitored for at least a day. After that, stroke care focuses on helping you recover as much function as possible and return to independent living. The impact of your stroke depends on the area of the brain involved and the amount of tissue damaged. If the stroke affected the right side of your brain, your movement and sensation on the left side of your body may be affected. If your stroke damaged the brain tissue on the left side of your brain, your movement and sensation on the right side of your body may be affected. Brain damage to the left side of your brain may cause speech and language disorders.

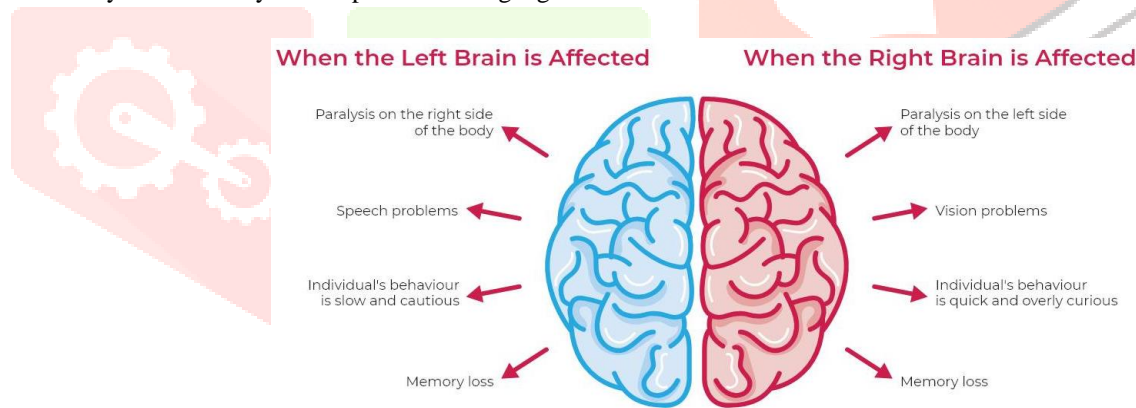

Fig. 1.2 Effects of stroke (Courtesy: <https://mystrokehospital.my/what-is-stroke/>)

1.6 Need for Study

The Pulse Oximeter values are affected by numerous factors. The area of measurement should be dry and clean with minimal movement. Dysrhythmia, shock, perfusion failure, abnormal pulsations, abnormal haemoglobin, use of vasoconstrictors, artifacts, dark skin, thick skin, and excessively hairy skin may lead to incorrect results. Hence we are doing cerebral oxymetry to get accurate SPO₂ values and during Cardiac surgery brain is the Least organ to be monitored on the operation theatre

II. LITERATURE SURVEY

W-Tash-et al (2016) Proposed to use Near Infra-Red Spectroscopy (NIRS) to measure the regional cerebral oxygen Saturation. The oximetry is a simple, non-invasive monitoring methodology that may improve patient outcome in a variety of different clinical situations. The cerebral oxygenation is calculated using the Beer-Lambert's law and spatial resolution. A Mathematical algorithm involving subtraction of values obtained from the emitters near and far from the photo detector is obtained as a reading. The results can be used to improve monitoring the patient outcomes in both cardiac and non-cardiac surgical patients.

Rom J (2017) validated and used NIRS in stroke and cardiac arrest patients to detect desaturation of the metabolically active brain but may exhibit normal values in absence of cerebral fusion. This prospective observations study was to evaluate changes in position using cerebral oximetry. The results demonstrate that rso₂ values for the brain measured by NIRS vary with patient's posture, higher in supine than in sitting position.

Yoshitani-et al(2007) evaluated clinically the skull thickness, the area of the cerebrospinal fluid layer, the mean arterial pressure and the hemoglobin concentration and found that all are determinants of the NIRS values. These parameters had no effect on the tissue oxygen index (TOI), which is the ratio of oxyhemoglobin to total hemoglobin.

Andre Y. Denault-et al (2018) proposed about the Near Infrared spectroscopy (NIRS) based on chromophore absorption of infrared light. There are four types of NIRS:- continuous, time domain, frequency domain and functional and numerous. NIRS is indicated when continuous monitoring of cerebral tissue perfusion is considered. Therefore the application of NIRS covers many procedures including cardiac and non-cardiac surgeries but also applications in intensive care and emergency medicine in other clinical and research areas.

A Kaya-et al(2015) analyzed the oxygen saturation level for seventy five neo-natal infants patients were compared by mother's age, delivery week, body weight, white blood cell counts and hemoglobin levels. The oxygen saturation level was taken with both pulse oximeter and cerebral oximeter in order to compare the values of both. The result demonstrates that cerebral oximeter is a promising modality in bedside monitoring in neonatal intensive care units.

III. HARDWARE COMPONENTS

3.1 ARDUINO UNO

Arduino is an open-source hardware and software company, project and user community that designs and manufactures single-board microcontrollers and microcontroller kits for building digital devices and interactive objects which will sense and control both physically and digitally. Arduino board designs use a spread of microprocessors and controllers. The boards feature serial communications interfaces, including Universal Serial Bus (USB) on some models, which also are used for loading programs from personal computers. The microcontrollers are typically programmed employing a dialect of features from the programming languages C and C++.



Fig 3.1 Arduino UNO

3.2 IR SENSOR

The IR sensor ARRAY of 8 channel is important in making a LINE Follower Robots. This sensor module has 8 IR LED/phototransistor pairs mounted on a 0.375" pitch, making it a great detector for a line-following robot. Pairs of LEDs are arranged in series to halve current consumption, and a IC allows the LEDs to be turned off for additional sensing or power-savings options. Each sensor provides a separate digital I/O-measurable output and Analog Output Also.

- Features:

Uses 8 sensors for best resolution.Great useful in building fast line following and grid navigating robots.Input Voltage: 5V DC.Comes with easy to use digital outputs that can be connected directly to microcontrollers.The array has mounting holes of 3 mm diameter for easy mounting.

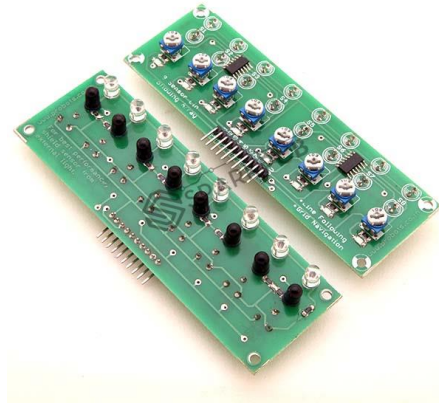

Fig. 3.2 Array IR sensor

3.3 OLED DISPLAY

- OLED displays driven by SSD1306 driver IC. SSD1306 is a CMOS OLED driver with controller for OLED dot-matrix graphic display system. Due to use of SSD1306 driver, number of external components required and power consumption has reduced.
- OLED is organic light emitting diode that emits light in response to an electric current. OLED display works with no backlight so it can display deep black levels. It is small in size and light in weight than Liquid Crystal Displays
- 128x64 OLED display is simple dot matrix graphic display. It has 128 columns and 64 rows which make it display of total $128 \times 64 = 8192$ pixels. By just turning on/off these pixel's led we can display graphical image of any shape on it.
- OLED display is used for displaying text, images and various patterns. It is also suitable for mobile phone sub-display, MP3 player, calculators etc.
- OLED display has 256 steps for brightness control.
- OLED display also available with different resolution like 128x32, 128x64. OLED display in above image has resolution of 128x64 pixels.

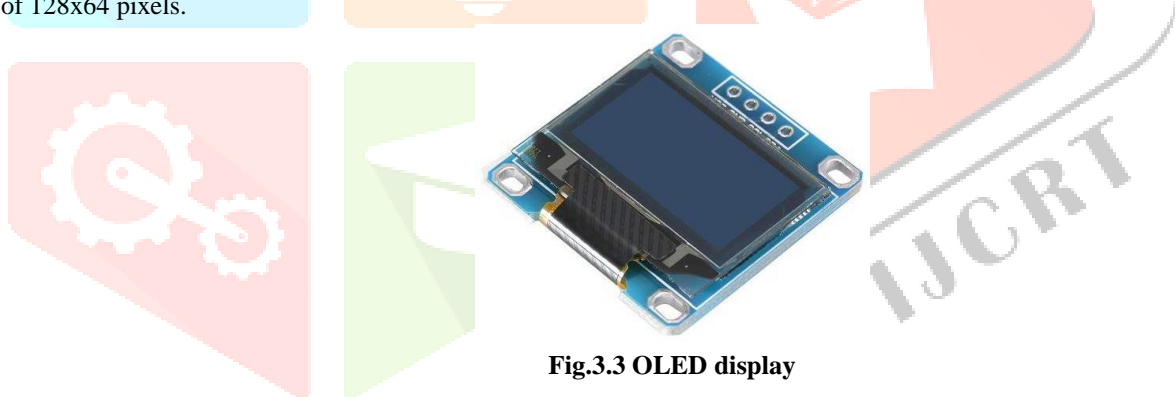

Fig.3.3 OLED display

IV. METHODOLOGY

In this project we are using embedded coding program on microcontroller to control various modules. The flow of embedded coding program is explained using the flow chart. First, we have to initialize the program by initiating IR sensor, the IR sensor used here is an 8 array IR sensor or an NIRS. If the IR sensor will not initialize, the code will start again before of the initialization of sensor condition or else IR sensor will initialize the data, which is shown on oled display and sends the data to the serial monitor simultaneously that will displayed. If the reading values are below 50 then the output displayed will be like 'HEAD NOT DETECTED' and if the values are between '50-300' then the output displayed will be like ' ABNORMAL VALUE' since the oxygen saturation value is below 60% , similarly if the output readings are >300 then the out put displayed on the OLED will be 'NORMAL VALUE' since the oxygen value is above 60%

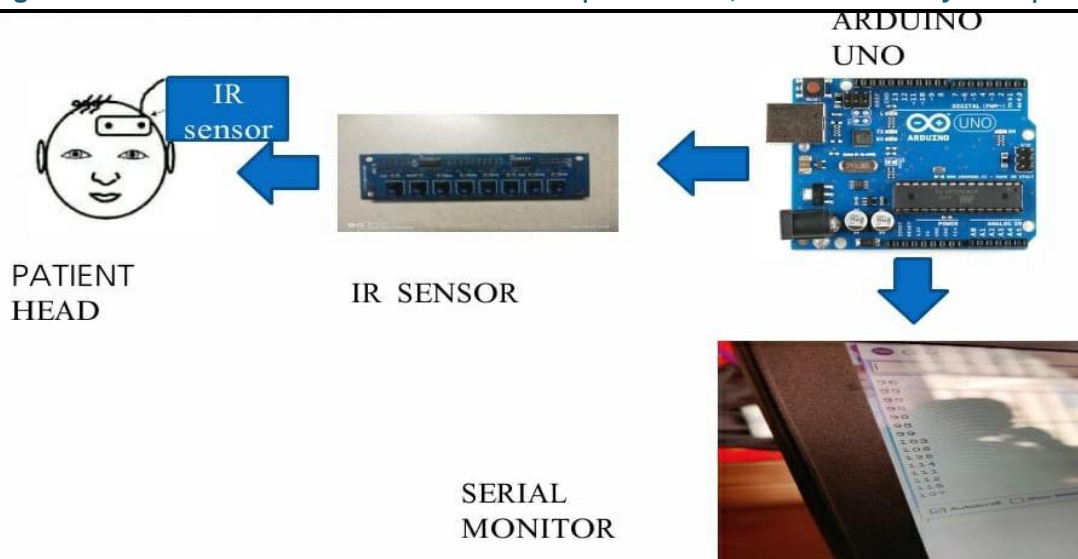

Fig.4.1 Block Diagram of Proposed System

4.1 Principle

The working principle of an infrared sensor is similar to the object detection sensor. This sensor includes an IR LED & an IR Photodiode, so by combining these two can be formed as a photo-coupler otherwise opto-coupler. The physics laws used in this sensor are planks radiation, Stephan Boltzmann & weins displacement.

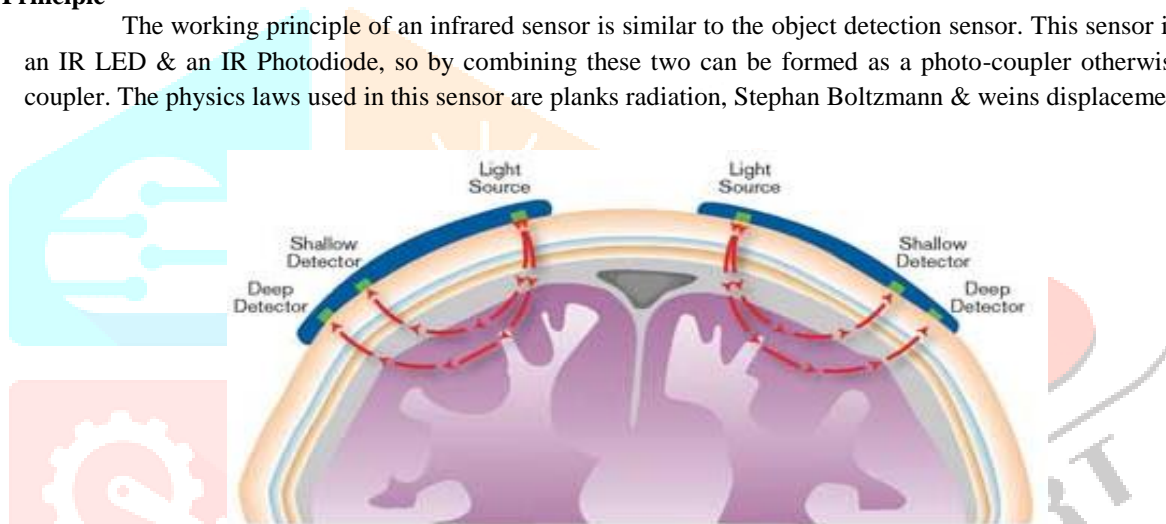

Fig.4.2 Diagram of cerebral oximetry (Photodetector & Light source)

4.2 The Beer-Lambert equation

The incident beam with intensity I_0 propagates through a test sample emerging from the other side with a reduced intensity I . If the interrogating beam only undergoes absorptive process by the compound with concentration of C the length of the light path is L . During the absorptive process, the energy of a photon raises a molecule to an excited state, which leads to an increase in molecular vibrations and an increase in temperature. In this way the photon is annihilated.

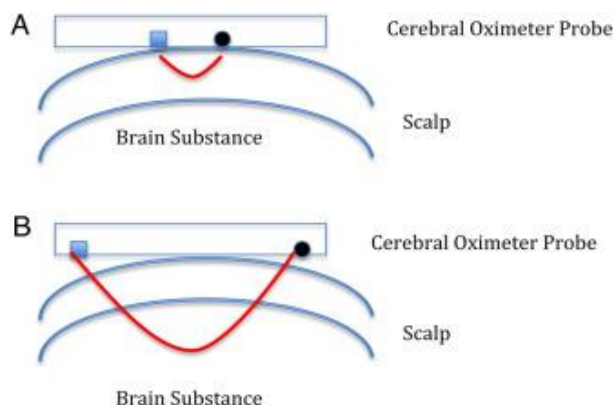

Fig.4.3 Placement of IR

The Lambert-Beer law describes the relationship between I_0 , I , $[C]$

$$\Delta\lambda_1 = (\epsilon_{O_2HB, \lambda_1} \Delta[O_2HB] + \epsilon_{dHB, \lambda_1} \Delta[dHB]) \zeta_1 L$$

$$\Delta\lambda_2 = (\epsilon_{O_2HB, \lambda_2} \Delta[O_2HB] + \epsilon_{dHB, \lambda_2} \Delta[dHB]) \zeta_2 L$$

$$\Delta\lambda_3 = (\epsilon_{O_2HB, \lambda_3} \Delta[O_2HB] + \epsilon_{dHB, \lambda_3} \Delta[dHB]) \zeta_3 L$$

Both the extinction coefficients (ϵ) and path length factors (ζ) have been determined for a range of different tissues on both adults and infants

4.3 Spatially resolved spectroscopy

Human tissue is highly scattering and the resultant high attenuation of light makes measurement with light source and detector on each side of, for instance the head practically impossible. In spatially resolved spectroscopy (SRS) the source and detector are adjacent and the process of backscatter is utilized. This multi-distance spectroscopy approach is based on the diffusion approximation for a highly scattering medium. SRS devices measure the reflected intensity in a series of separate detectors with fixed spacing between them. Linear regression on the logarithms of these intensities gives an estimate of the gradient of attenuation with respect to source/detector spacing. Under the assumption $\mu_a + \mu'_s \approx \mu'_s$ (attenuation due to scattering is much larger than due to absorption), the following relation can be derived:

$$\mu_a \mu'_s \approx (\partial A / \partial \rho - 2/\rho)^{2/3}$$

4.4 Proposed System Architecture

System overview

The smart headband system is a wearable and affordable technology, which addresses the current issues in patient's health care. The smart headband system integrated the IR sensor. The IR sensor passes the IR rays which penetrates through the head and calculated the oxygen saturation level in the cerebral region.

Hardware architecture

Arduino UNO is used to control all the components used in this system which is connected to the infra red sensor to sensor to sense the blood oxygen saturation. The IR sensor will sense and send the data to the microcontroller then it will send to the oled display simultaneously to the serial monitor in the pc. The port cable connects the arduino with pc which will provide power supply to the entire circuit. The IR sensor while placed on patient's head is displayed on oled display.

In Fig. 5.1., all the sensors are connected to the Arduino UNO. All the sensors are given with the current supply of 5v and the grounds are grounded. The circuit has the connection from Arduino UNO to the IR SENSOR and the OLED Display.

Arduino to IR sensor connection:

- 1 PIN (IR) - A0 (Arduino)
- 2 PIN (IR) - A1 (Arduino)
- 3 PIN (IR) - A2 (Arduino)
- 4 PIN (IR) - A3 (Arduino)
- 5 PIN (IR) - A4 (Arduino)
- 6 PIN (IR) - A5 (Arduino)

Arduino to OLED display:

- VCC (IR) - 5V (Arduino)
- GND (IR) - GND (Arduino)

The Arduino is connected to the PC through the port cable which is used for the display of serial monitor and for Arduino power.

- SCL (OLED) - SCL (Arduino)
- SDA (OLED) - SDA (Arduino)
- VCC (OLED) - 5V (Arduino)
- GND (OLED) - GND (Arduino)

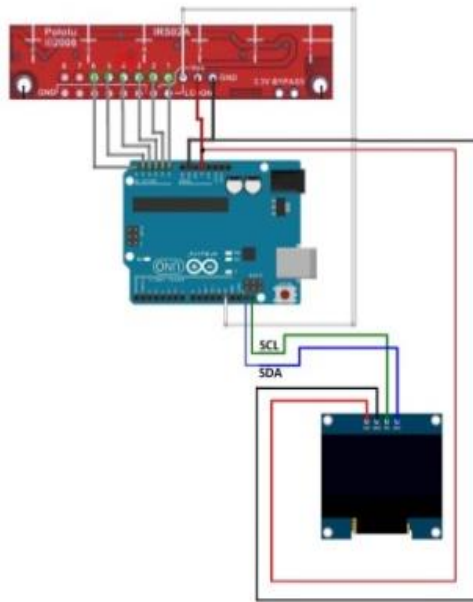

Fig.5.1 Circuit diagram

V. RESULT AND DISCUSSION

The penetrated IR through the skull reflects the ir light after absorption of light by the haemoglobin present in the frontal region. The values can be seen in the serial monitor which gives accurate reading through Arduino program. The headband is placed in the patient's head, the sensor touching the frontal skin. Collection of several trails from a subject for different age, gender, and skin types to get more accuracy results.

Table 1. Data collected from different subjects

SUBJECT	AGE/GENDER	IR REFLECTED VALUES(BYTES)
1	30/M	426
2	26/F	318
3	55/F	582
4	4/F	273
5	24/F	354
6	28/M	563
7	11/F	322
8	8/M	311
9	32/F	405
10	33/M	328
11	54/M	512
12	50/F	575
13	20/M	347

The displayed Tabular representation is the data collected from different subjects. The subjects are of different age groups varying from 4-55 years. The data were collected from both male and female subjects, for further references their medical history were also collected. The subjects from which we collected the data, there were children, heart patients, few had a history of blood pressure and also blood glucose i.e diabetic.

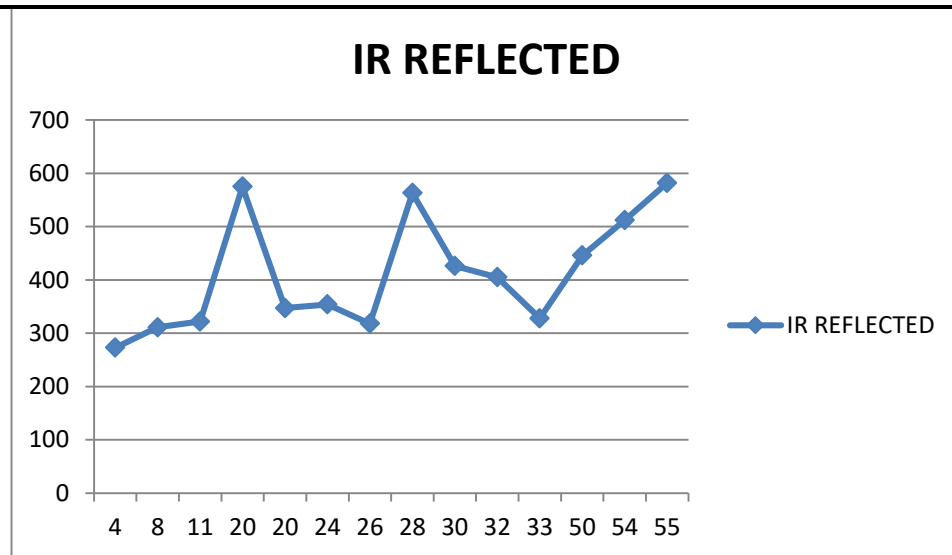

Fig.5.1 Graphical representation of the data

Graphical representation of the data collected from different subjects. The x-axis represents the different age of the subjects and whereas the y-axis represents the IR reflected rays.

When the headband is not placed on the head the output shown in the serial output is 'HEAD NOT DETECTED'. When the headband is placed and the readings are obtained and the values satisfy the normal condition the output will be 'NORMAL CONDITION'. When the headband is placed and the readings are obtained and the values does not satisfy the normal condition then the output will be 'ABNORMAL CONDITION'.



Fig 5.2 Designed Head band and Demo

VI. CONCLUSION AND FUTURE WORK

The penetrated IR through the skull reflects the ir light after absorption of light by the haemoglobin present in the frontal region. The values can be seen in the serial monitor which gives accurate reading through Arduino program. The headband is placed in the patient's head, the sensor touching the frontal skin. Collection of several trails from a subject for different age, gender, and skin types to get more accuracy results. The application of near-infrared spectroscopy as a monitoring tool in non cardiac surgery.

This wearable healthcare system was designed to be used in the operation theatre while performing surgery and pre surgery. The headband reads the oxygen saturation level in the cerebrum, which is mostly ignored during the surgery. In the future this smart head band can be used by everyone like the smart watches.

REFERENCES

- [1] W Tosh, FRCA, M Patteril, MD FRCA DipClinEdu (RCS), Cerebral oximetry, *BJA Education*, Volume 16, Issue 12, December 2016, Pages 417–421, <https://doi.org/10.1093/bjaed/mkw024>.
- [2] A Kaya-et-al, (2015) ‘ Comparison of cerebral oximeter and pulse oximeter values in the first 72 hours in premature , Asphyctic and healthy newborns’.Guilio pons, (2020) ‘oximeter sensors’.
- [3] Sofia Bobby J, “Peak alpha Neurofeedback training on cognitive performance in elderly subjects” in the International journal of Medical Engineering and Informatics (IJMEI), Vol 12,No.3, April 2020
- [4] Murkin JM, Arango M. Near-infrared spectroscopy as an index of brain and tissue oxygenation. *Br J Anaesth*. 2009 Dec;103 Suppl 1:i3-13. doi: 10.1093/bja/aep299. PMID: 20007987.E M Nemoto-et-al, (2000)
- [5] Nemoto EM, Yonas H, Kassam A. Clinical experience with cerebral oximetry in stroke and cardiac arrest. *Crit Care Med*. 2000 Apr;28(4):1052-4. doi: 10.1097/00003246-200004000-00023. PMID: 10809281.
- [6] Bozkurt, A., Rosen, A., Rosen, H. *et al*. A portable near infrared spectroscopy system for bedside monitoring of newborn brain. *BioMed Eng OnLine* 4, 29 (2005). <https://doi.org/10.1186/1475-925X-4-29>
- [7] Sanfilippo F, Serena G, Corredor C, Benedetto U, Maybauer MO, Al-Subaie N, Madden B, Oddo M, Cecconi M. Cerebral oximetry and return of spontaneous circulation after cardiac arrest: A systematic review and meta-analysis. *Resuscitation*. 2015 Sep;94:67-72. doi: 10.1016/j.resuscitation.2015.06.023. Epub 2015 Jul 6. PMID: 26159613.
- [8] Goldman SM,(2006) Sutter FP, Wertan MA, et al. Outcome improvement and cost reduction in an increasingly morbid cardiac surgery population. *Semin Cardiothorac Vasc Anesth* .
- [9] Likosky DS,(2003) Leavitt BJ, Marrin CA, et al. Intra- and postoperative predictors of stroke after coronary artery bypass grafting. *Ann Thorac Surg*.
- [10] Denault A,(2007) Deschamps A, Murkin JM. A proposed algorithm for the intraoperative use of cerebral near-infrared spectroscopy. *Semin Cardiothorac Vasc Anesth*.
- [11] Slater JP, Guarino T, Stack J, et al.(2009) Cerebral oxygen desaturation predicts cognitive decline and longer hospital stay after cardiac surgery.
- [12] Yao FS, Tseng CC, Ho CY, et al.(2004) Cerebral oxygen desaturation is associated with early postoperative neuropsychological dysfunction in patients undergoing cardiac surgery. *J Cardiothorac Vasc Anesth*
- [13] Casati A, Fanelli G, Pietropaoli P, et al.(2005) Continuous monitoring of cerebral oxygen saturation in elderly patients undergoing major abdominal surgery minimizes brain exposure to potential hypoxia.
- [14] Tobias JD.(2008) Cerebral oximetry monitoring with near infrared spectroscopy detects alterations in oxygenation before pulse oximetry. *J Intensive Care Med* 8.

