



Review of Signal Processing Techniques for Detection of Power Quality Events

¹Mr.Akhilesh Kumar Singh, ²Prof. Ashish V. Harkut, ³Prof. Parag R. Jawale

¹ M.E Student Electrical Engineering (Electrical Power system) Pankaj Laddhad Institute of Technology and Management Studies Buldana, ² Assistant Professor & HOD at EE Department, Pankaj Laddhad Institute of Technology and Management Studies Buldana, ³Assistant Professor at EE Department, Pankaj Laddhad Institute of Technology and Management Studies Buldana

Abstract: The challenging process industry requires true power for its smooth functioning and here comes the importance of good power or power. The term Power Quality (PQ) aims at supplying true power to the process. The scope of the power quality increased with the introduction of newly designed sophisticated devices like computers and microcontrollers. The performances of these devices are extremely sensitive to the various power quality problems. The mainly occurring PQ problems are voltage sag, voltage swell, voltage flickers, harmonics distortions etc. The concept of power quality became increasingly complex and vital with the introduction of recently designed sophisticated and sensitive devices, whose real time performance is extremely subjective to sensitiveness of the supply. Power Quality (PQ) has turned to be a serious issue to electricity consumers at all levels. Power quality is a major concern to electricity consumers today. The sensitivity factor of the power electronic equipment and non-linear loads to the input excitations voltages are widely used in process control as well as individual consumers which lead to the PQ problem. The paper gives a brief review in accordance with relevant literature surveys classifies the various electric power quality disturbances using wavelet transform analysis. The survey includes detection voltage disturbances and categorization of the type of event. The power quality analyzer is designed and used to measure the occurrence and classification of PQ events. Malfunction of the equipment will happens when the power failure occurs. Several signal processing techniques for the detection and classification of these disturbances are studied and discussed here. The detection techniques are mainly based on signal averaging, RMS method, Kalman Filter method, Fourier Transforms, Wavelet Transforms etc. Wavelets and fast Fourier transforms are of major importance in the classification.

Index Terms – Power Quality (PQ), Wavelet Transform (WT), Support Vector, Machines (SVM)

I. INTRODUCTION

As the power quality problems are undesirable to the electrical system, the accurate and early detection of these is very important. The effectiveness of the correct detection is very much helpful in the proper mitigation of the problems. For the proper mitigation, it is necessary to extract the properties of the signal disturbance. The presence of odd harmonics is the major cause for these disturbances. For the proper functioning of electrical devices, the amount of harmonics should be reduced to its minimum limits. The supreme quality is demanded for the rapid involvement of sensitive electronic equipments in electrical industries. In the present industrialized world, because of the continuous usage and increase in sources of disturbance, the electric power system is subjected to sudden variations in the output voltage signals. When the current and voltage caused by these harmonics are exceeded the safely limits, results in the damage of electrical equipments. This can be correctly mitigated only through proper classification of the type of fault present in the live system. The quality of the power is gaining importance due to the great damage caused by Power Quality (PQ) disturbances. The damage caused by power quality problems is clearly noticeable at a greater level in the economic point of view. The first step in improving the power quality is the detection of the sources of PQ and then only mitigation can be applied. Aiming to obtain solutions to detect and to classify disturbances, many methods have been studied in this study. There are many methods based on visual waveform analysis but they cannot be used in real time applications. The signal processing methods (Bollen and Gu, 2006) enabled to develop methods that are more reliable and accurate. This paper deals with a study and survey concentrated on the various signal processing methods for accurate detection and classification of power quality problems. The efficiency of the classification algorithm is very much important for the accurate design of the mitigation control system. The main types of classifications discussed in this study are RMS method, Short Time Fourier Transform (STFT), Fast Fourier Transform (FFT), Wavelet Transform (WT) and Discrete Wavelet Transform (DWT). Among this the RMS method is the most general type and having the drawback of the inability to distinguish between the fundamental frequency and the harmonics components. The phase angle calculations are also cannot be done in the RMS method. For the accurate mitigation, there must be a thorough idea about the source of disturbance. This will employ us to choose a proper mitigation method. The classification based on signal processing techniques is regarded to be an accurate one and covers the localization of the fault event, duration and type of events. This method is regarded as reliable technique when the automated control mechanism is incorporated with different soft computing like AI based controllers. This also improves the speed of data processing for real time mitigation and also having tabular based data storage for further references. The power quality disturbance are non stationary and non linear in nature. The classification of these varying signals is done in two ways, namely

transformation based and amplitude frequency based methods. The identification and classification of the various types of real time power quality disturbances are done with reference to standards and recommendations of IEEE. The use of Wavelet transforms for power quality classifications is of two types namely, data compression of the fault and wavelet packet transforms. The data compression is made using the signal decomposition and reconstruction of the patterns. It also goes for localization of samples. The identifications are done based on the comparison of the characteristics of both the actual and measured signals. It is observed that the Wavelet based method is more reliable in defining the characteristics of the fault events.

II. POWER QUALITY

Power quality is a simple term, yet it describes a multitude of issues that are found in any electrical power system and is a subjective term. The concept of good and bad power depends on the end user. If a piece of equipment functions satisfactorily, the user feels that the power is good. If the equipment does not function as intended or fails prematurely, there is a feeling that the power is bad. In between these limits, several grades or layers of power quality may exist, depending on the perspective of the power user. The understanding of power quality issues is a good starting point for solving any power quality problem.

There are different definitions of power quality.

- According to Utility, power quality is reliability.
- According to the load aspect, it is defined as the power supplied for the satisfactory performance of all equipment i.e., all sensitive equipment.
- This depends upon the end-user. According to the end-user point of view, it is defined as, “any power problem manifested in voltage, current, or frequency deviations that result in failure or maloperation of customer equipment”
- According to IEEE, it is defined as “the concept of powering and grounding sensitive equipment in a matter that is suitable to the operation of that equipment”.
- According to IEC, it is defined as, “set of parameters defining the properties of the power supply as delivered to the user in normal operating conditions in terms of continuity of supply and characteristics of voltage (magnitude, frequency, waveforms).

III. POWER QUALITY DISTURBANCES

• Voltage Sag

This is a short-term, few-cycles duration, drop in voltage in the range of 0.1 to 0.9 p.u, for duration greater than half a mains cycle and less than 1 minute. Voltage sags are usually associated with system faults but can also be caused by switching of heavy loads or starting of large motors. Voltage sag can cause loss of production in automated process since a voltage sag trip a motor/system or cause its controller to malfunction, it may be very costly to end user as machine/system downtime, scrap cost, cleanup cost, product quality and repair costs makes these types of problems costly. Impact of long duration variation is greater than those of short duration variation.

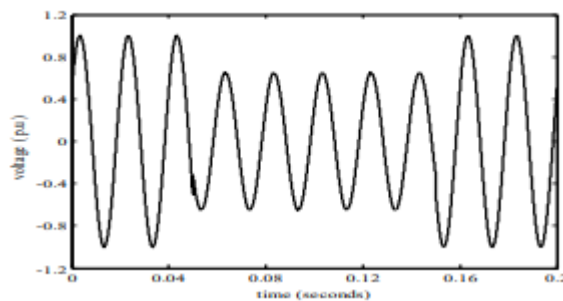

FIGURE 1:- VOLTAGE SAG

• Voltage Swell

This is a short term increase in voltage of a few cycles duration, voltage swell is an increase in RMS voltage (as shown in fig) in range of 1.1 to 1.8 p.u for duration greater than half a mains cycle and less than 1 minute. Swells are usually associated with system fault conditions, but they are much less common than voltage sags. A swell can occur due to a single line-to-ground fault on the system resulting in a temporary voltage rise on the unfaulted phases. Swells can also be caused by switching off a large load or switching on a large capacitor bank. Voltage swells can put stress on computer and many home appliances, there by shortening their lives. Voltage swell may also cause tripping of protective circuit of an adjustable speed drive.

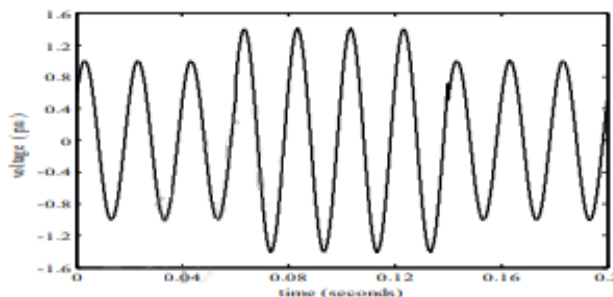

FIGURE 2:- VOLTAGE SWELL

• Interruption

An interruption occurs when the supply voltage or load current (as shown in fig.) decreases to less than 0.1 p.u for a period of time not exceeding 1 minute. Interruptions can be the result of power system faults, equipment failures, and control malfunctions. The interruptions are measured by their duration since the voltage magnitude is always less than 10% of nominal. The duration of an interruption due to a fault on the utility system is determined by utility protective devices and the particular event that is causing the fault. The duration of an interruption due to equipment malfunctions or loose connections can be

irregular. Ninety percent of fault on overhead distribution lines are of temporary nature. Typically, these faults result from lightning, tree limbs or animals causing ground or shorts. Distribution lines are protected by, a form of a circuit breaker called a reclosure. Reclosures interrupt faults, then automatically restore the circuit, or reclose, and if the fault has cleared, the reclosure stage closed. If the fault still persists, the reclosure trips and again automatically close back in. A temporary interruption lasting a few seconds can cause a loss of production, erasing of computer data etc. The cost of such an interruption during peak hours can be very heavy.

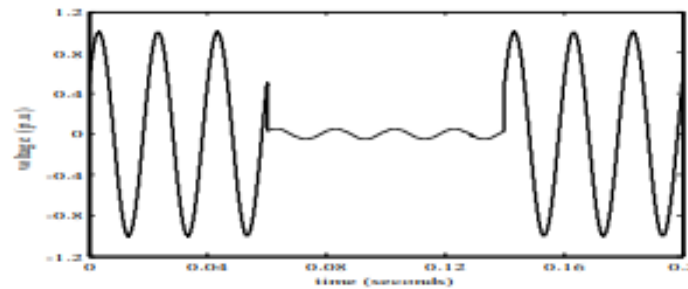

FIGURE 3:- VOLTAGE INTERRUPTION

- **Transients**

This is an undesirable momentary deviation of the supply voltage or load currents. Transients are generally classified into two categories, (1) Impulsive (2) Oscillatory. These terms reflect the wave-shape of a current or voltage transient.

A) Impulsive Transient:

An impulsive transient is a sudden, non-power frequency change in the steady-state condition of voltage, current, or both, that is unidirectional in polarity (primarily either positive or negative) as shown in fig. These are commonly known as switching surges or voltage spikes. They can be caused by circuit breakers out of adjustment, capacitors switching, lightning, or system faults.

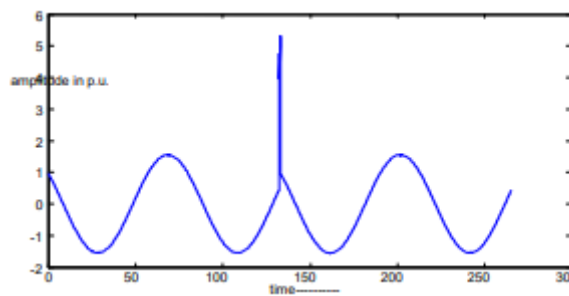

FIGURE 4:- IMPULSIVE TRANSIENT

B) Oscillatory Transient:

- High Frequency Oscillatory Transient:
- Medium Frequency Oscillatory Transient:
- Low Frequency Oscillatory Transient:

An oscillatory transient is a sudden, non-power frequency change in the steady state condition of voltage, current, or both, that includes both positive and negative polarity values.

An oscillatory transient consists of a voltage or current whose instantaneous value changes polarity rapidly. It is described by its spectral content (predominate frequency), duration, and magnitude. The spectral content subclasses defined in the table are high, medium, and low frequency. The frequency ranges for these classifications are chosen to coincide with common types of power system oscillatory transient phenomena.

Oscillatory transients with a primary frequency component greater than 500 kHz and a typical duration measured in microseconds (or several cycles of the principal frequency) are considered high frequency oscillatory transients. These transients are often the result of a local system response to an impulsive transient. A transient with a primary frequency component between 5 and 500 kHz with duration measured in the tens of microseconds (or several cycles of the principal frequency) is termed a medium frequency transient. Back-to-back capacitor energization results in oscillatory transient currents in the tens of kilohertz as illustrated in the following figure. Cable switching results in oscillatory voltage transients in the same frequency range. Medium frequency transients can also be the result of a system response to an impulsive transient. A transient with a primary frequency component less than 5 kHz, and duration from 0.3 ms to 50 ms, is considered a *low frequency transient*. This category of phenomena is frequently encountered on utility sub transmission and distribution systems and is caused by many types of events. The most frequent is capacitor bank energization, which typically results in an oscillatory voltage transient with a primary frequency between 300 and 900 Hz. The peak magnitude can approach 2.0 pu, but is typically 1.3 - 1.5 pu with a duration of between 0.5 and 3 cycles depending on the system damping. The following figure shows low frequency oscillatory transient caused by capacitor-bank energization.

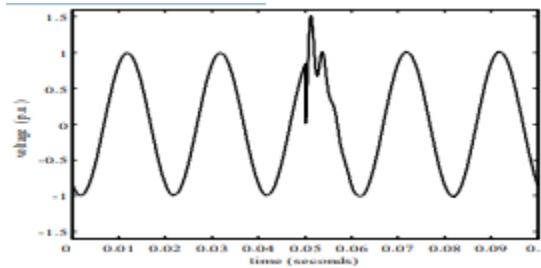

FIGURE 5:- OSCILLATORY TRANSIENT

- **Harmonics**

It is a sinusoidal component of a periodic wave or quality having a frequency that is an integral multiple of the fundamental frequency as shown in fig.8. Harmonics can be considered as voltages and/or current present on an electrical system at some multiple of the fundamental frequency. Non-linear elements in power systems such as power electronic switches/static power converters, saturated magnetic components and arc discharge devices, and, to a lesser degree rotating machines, create current distortion. Static Power converters of electrical power are largest nonlinear loads and are used in industry for a variety of purposes, such as electrochemical power supplies, adjustable speed drives, and uninterruptible power supplies. These devices are useful because convert ac to dc, dc to dc, dc to ac, and ac to ac. Harmonics cause wave from distortion power system problems such as communication interference, heating, and solid-state device malfunction can be direct result of harmonics.

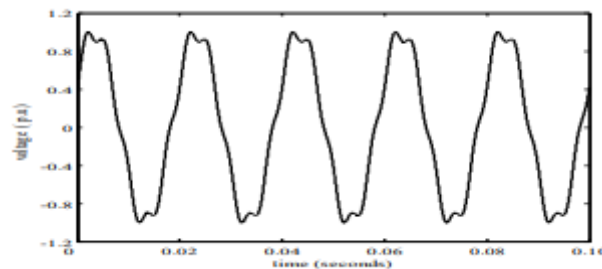

FIGURE 6:- HARMONICS

- **Voltage Unbalance**

Voltage imbalance is, deviation in the magnitude and phase of one or more of the phases, of a three-phase supply, with respect to the magnitude of the other phase and the normal phase angle (120°). Voltage imbalance (or unbalance) is defined as the ratio of the negative or zero sequence components to the positive sequence component. The negative or zero sequence voltages in a power system generally result from unbalanced loads causing negative or zero sequence currents to flow. Voltage imbalance can cause temperature rise in motors and can even cause a large motor to trip.

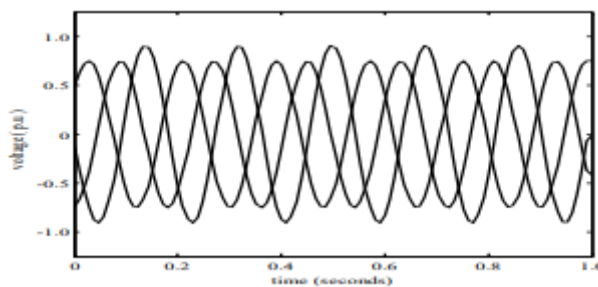

FIGURE 7:- VOLTAGE UNBALANCE

- **Voltage Flicker**

Flicker is defined as the “Impression of fluctuating brightness or color, occurring when the frequency of observed variation lies between a few Hertz and the fusion frequency of images”. Flicker comes from the aggravating, rapid on-off sensation of incandescent and fluorescent lamps as perceived by the human eye. It results from the rapid variation in voltage due to fast load changes. Flicker can result from electric arc furnaces, welders, rapidly cycling loads or it can result from a large ASD with inadequate DC-link filtering on a weak distribution system. With inadequate DC-link filtering, the inverter harmonics, which are a function of a non 50/60 Hz fundamental, flow into the power system, causing a pulsating of the 50/60 Hz fundamental. Voltage flickers are caused by arc discharge lamps, arc furnaces, starting of large motor, arc welding machines etc. Flicker caused light intensity from incandescent lamps to vary, makes visual irritation to human observers. It has adverse effects on human health as the high frequency flickering of light bulbs, fluorescent tubes or television screen can cause strain on the eyes resulting in headaches or migraines. The flicker also reduces the life span of electronic equipment, lamps etc.

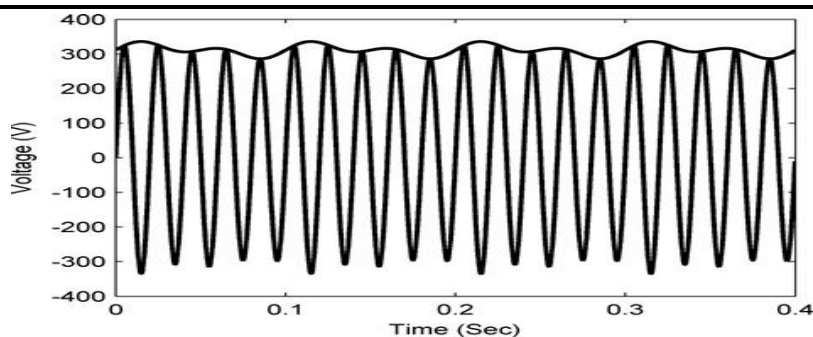

FIGURE 8:- VOLTAGE FLICKER

IV. POWER QUALITY SIGNAL PROCESSING METHODS

The use of signal processing for power quality applications is not a new idea, as several researchers have used signal processing for more than a couple of decades. In the past few years, however, there has been a renewed interest in exploiting signal processing techniques for power quality measurements and analysis. The Table 1 discusses the various power quality events and their respective IEEE/IEC standards. The disturbance capturing techniques are usually based on detecting the power quality events when a certain threshold level is exceeded

➤ The RMS Method

RMS is the most common and easy method of signal classification. The normal signal variations are classified by the RMS values. This method is somehow acceptable for looking at simple fault events. But for a complex system having different faults occurring at a time, this method is not reliable. The main disadvantage is its dependence on the lesser size of the signals and also it fails to distinguish between fundamental frequency and harmonics.

➤ Fast Fourier Transform (FFT)

Fourier Transform is used to convert a time domain signals into its corresponding frequency components. This is effective for periodical signals to obtain its magnitudes and phases. The Discrete Fourier Transform (DFT) is an advanced technique of Fourier transform analysis. FFT is considered as a faster version of DFT, the sampling is done in a windowed manner. But FFT is not emerged as an efficient method in the analysis of extracting the information of the non stationary as well as non linear signals. The Discrete Fourier Transform (DFT) is then considered as a reliable tool for signal decomposition analysis. The introduction of FFT can reduce the overall computation time and thereby able to choose an efficient mitigation algorithm

➤ Short Time Fourier Transform

It is commonly known as the sliding window version of FFT, having rather good results in terms of frequency compared with other classification techniques. It also shows poor results for time varying and non linear signals. It can divide lengthy time varying signals into corresponding shorter segments so that the computation complexity is reduced

➤ Wavelet Transform (WT)

While compared to the above mentioned techniques, the Wavelet transforms are very fast and reliable technique for feature extraction of non stationary signals like voltage sag and swells. The Wavelet can have the ability to extract the features within a short interval of time. This can be achieved for both high frequency and low frequency components of the waveform. The method of analysis of different frequencies is generally adapted and is known as Multi Resolution Analysis (MRA). It has a drawback of poor frequency response at high frequency components. The energy analysis is done for all levels. The Wavelet energy is the sum of squares of the total level of Wavelet coefficients. This energy level is varying for different scales of transformations. This energy analysis is very helpful in classifying the distorted signals. The energy coefficients of the distorted signals will be given for detailed analysis. The Daubenchies "db4" type of Wavelets is selected for signal decomposition for classification purposes. Here the shifting and scaling operations are performed on the mother Wavelet and obtaining the resultant (daughter) Wavelet. It can be a representation of both frequency and time domains. This feature differs Wavelets from Fourier Transform representations as FT gives a representation only in terms of frequency. The WT analysis is done in three types namely, Continuous Wavelet Transforms) CWT, Wavelet series and Discrete Wavelet Transforms (DWT).

Table 1:- Power quality events and their standards

Events	Standards
Classification of power quality	IEC61000-2-1:1990, IEC 61000-2-5:1995
Monitoring of power quality	IEEE 1159:1995
Transients	IEC 816:1984 IEC 61000-2-1:1990 IEEE C62:41:1991, IEEE 1159:1995
Voltage sag/swell and interruptions	IEC 61009-2-1:1990, IEEE 519:1992
Harmonics	IEC 61000-2-1:1990; IEEE 519:1992
Voltage flicker	IEC 61000-4-15:1997

➤ Discrete Wavelet Transforms (DWT)

In numerical analysis and functional analysis, a Discrete Wavelet Transform (DWT) is any wavelet transform for which the wavelets are discretely sampled. As with other wavelet transforms, a key advantage it has over Fourier transforms is temporal resolution: It captures both frequency and location information (location in time). Other forms of discrete wavelet transform include the non- or undecimated wavelet transform (where down sampling is omitted), the Newland transform (where an orthonormal basis of wavelets is formed from appropriately constructed top-hat filters in frequency space). Wavelet packet transforms are also related to the discrete wavelet transform. Complex wavelet transform is another form. To extend the

frequency resolution, decomposition of signal is done repeatedly and signal can be realized into two lower frequency ranges. This process is known as multi resolution analysis. Table 2 gives an overview and comparison of commonly used wavelets. Among these wavelets, Daubechies wavelet is suitable for power quality analysis. In commonly used wavelets daubechies wavelet is one of the most widely used mother wavelets. As per IEEE standards, Daubechies wavelet transform is very accurate for analyzing Power Quality Disturbances among all the wavelet families, for transient faults. The names of the Daubechies family wavelets are written as DbN, where N is the order and db the “surname” of th wavelet. Matlab has an efficient wavelet tool box where the signal classification is done in an easier way. The wavelet transform is more suitable because of its capability of coefficient detection in short time interval and the ability to select short band pass spectrum an also to save the information in time-frequency domain, without energy aliasing. The statistical parameters of wavelet coefficients like mean, median, SD, absolute value etc. can easily represent Daubechies (db), the mother wavelet function .These feature extraction techniques will help to reduce the dimension of sampled signal and thereby reducing the computation time and increasing accuracy is demanded

V. SIMULATION FOR POWER QUALITY DISTURBANCE GENERATION

The test environment is created in Matlab’s Simulink. The various power quality disturbances like voltage sag and swell, voltage harmonics etc. are observed in the work space. The Figure 9 shows the two level wavelet packet decomposition schematics. The signal processing analysis was done on these disturbances. The Daubechies (Db) family of wavelets are studied in Figure 10. The complete signal is analyzed using Matlab signal processing tool box.

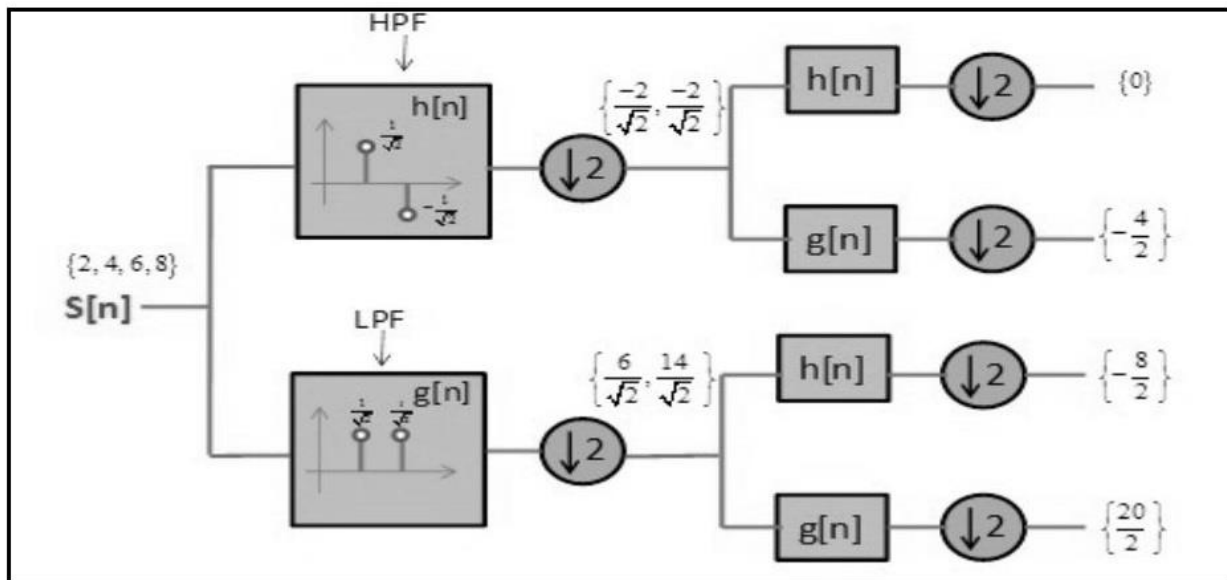

Figure 9:- Two level wavelet packet decomposition

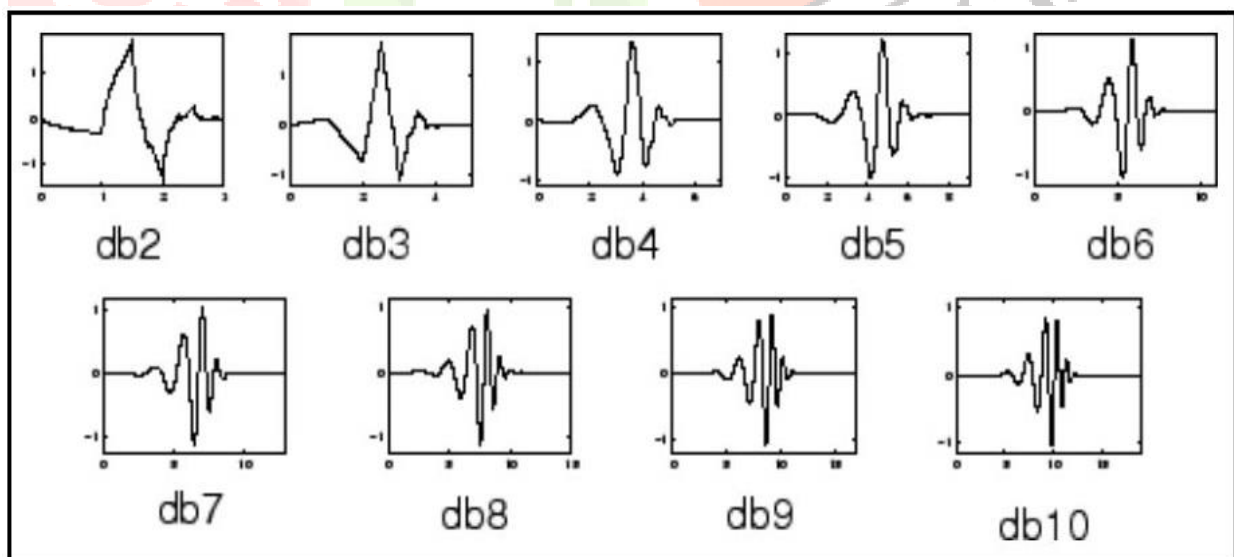

Figure 10:- The Daubechies (Db) family of wavelets

➤ Support Vector Machines (SVM)

This is a new technique used in signal processing to separate different patterns by means of pattern recognition. It is based on statistical learning theory made by learning from the collected set of data. The problem of optimization arises in the learning stage itself and the data classification is done by SVM. It is also regarded as a supervised learning method as similar in many artificial intelligent techniques. The SVM chooses a set of samples; known as training examples for signal classification. It can classify in 2-D and also for non linear signals. SVM is regarded as the most efficient feature extraction method available so far. The classification uses Radial Basis Function (RBF) kernel and shows best result (Barros *et al.*, 2012). The voltage sag and swell waveforms generated are analyzed using “haar wavelet”, which is re synthesized square shaped signals. This is a particular

case of the Daubechies Wavelet (D2). The haar wavelet is the simplest among all other classifications. This can be easily used in simple 2-D signals. When considering the discrete domain, discrete haar wavelets are used for synthesis. The disturbance signals are decomposed at completely at a level of 5. The above table shows the comparison of various power quality signals using the wavelet tool. The detailed decomposition is studied and relevant classification is done. Sag and swell is generated for a 440 V input using a three phase fault. The disturbance is observed in all the three phases.

VI. Conclusion

The study of power quality became one of the emerging and major concerns for the safe use of sensitive equipments. Extreme accuracy is required in this area as a slight variation in voltage will cause heavy damage to the operating equipment. The importance of signal processing will be there in the safe and fast identification of these new signals. This paper studies the various techniques that are consistently used for the analysis of power quality disturbances. Different techniques like feature extraction, feature selection and feature classification is discussed with the help of Matlab's Simulink tool boxes. The behavior of the voltage sag and swell is discussed using the behavior and statistics of the extracted samples at different decomposition levels. The Daubechies (db) wavelet transform is effectively used for the statistical parameter coefficient estimation. The SVM reduces the number of operations required on the decomposition stage.

REFERENCES

- 1] S. Khokhar, A. A. M. Zin, A. S. Mokhtar and N. Ismail, "MATLAB/Simulink based modeling and simulation of power quality disturbances," 2014 IEEE Conference on Energy Conversion (CENCON), Johor Bahru, 2014, pp. 445-450, DOI: 10.1109/CENCON.2014.6967545.
- 2] T. Zhong, S. Zhang, G. Cai, Y. Li, B. Yang and Y. Chen, "Power Quality Disturbance Recognition Based on Multiresolution S-Transform and Decision Tree," in IEEE Access, vol. 7, pp. 88380-88392, 2019, doi: 10.1109/ACCESS.2019.2924918.
- 3] M. Meena, O. P. Mahela, M. Kumar and N. Kumar, "Detection and Classification of Complex Power Quality Disturbances Using Stockwell Transform and Rule Based Decision Tree," 2018 International Conference on Smart Electric Drives and Power System (ICSEDPS), Nagpur, 2018, pp. 220-226, doi: 10.1109/ICSEDPS.2018.8536028
- 4] G. S. Chawda et al., "Comprehensive Review on Detection and Classification of Power Quality Disturbances in Utility Grid With Renewable Energy Penetration," in IEEE Access, volume 8, pages 146807-146830, 2020, DOI:10.1109/ACCESS.2020
- 5] S. Santoso, E. J. Powers, and W. Grady, "Power quality disturbance identification using wavelet transformers and artificial neural network," in Proc. Int. Conf. Harmonic and Quality of Power, Las Vegas, NV, 1996, pp. 615-618.
- 6] M. K. Elango and K. Loganathan, "Classification of power quality disturbances using Stockwell Transform and Back Propagation algorithm," 2016 International Conference on Emerging Technological Trends (ICETT), Kollam, 2016, pp. 1-7, doi: 10.1109/ICETT.2016.7873713.
- 7] S. Kamble and I. Dupare, "Detection of power quality disturbances using wavelet transform and artificial neural network," 2014 Annual International Conference on Emerging Research Areas: Magnetics, Machines and Drives (AICERA/iCMMD), Kottayam, 2014, pp. 1-5, doi: 10.1109/AICERA.2014.6908252.
- 8] Y. Xu, Y. Gao, Z. Li and M. Lu, "Detection and classification of power quality disturbances in distribution networks based on VMD and DFA," in CSEE Journal of Power and Energy Systems, vol. 6, no. 1, pp. 122-130, March 2020, doi: 10.17775/CSEEJPES.2018.01340.
- 9] M. A. Rodriguez, J. F. Sotomonte, J. Cifuentes and M. Bueno-López, "Classification of Power Quality Disturbances using Hilbert Huang Transform and a Multilayer Perceptron Neural Network Model," 2019 International Conference on Smart Energy Systems and Technologies (SEST), Porto, Portugal, 2019, pp. 1-6, doi: 10.1109/SEST.2019.8849114.
- 10] F. Z. Dekhandji, "Detection of power quality disturbances using discrete wavelet transform," 2017 5th International Conference on Electrical Engineering - Boumerdes (ICEE-B), Boumerdes, 2017, pp. 1-5, doi: 10.1109/ICEE-B.2017.8192080.
- 11] Kapoor, R. and M.K. Saini, 2010a. Classification of non linear power quality events based on Multiwavelet transform. Int. J. Nonlinear Sci., 10: 279-286.
- 12] Kapoor, R. and M.K. Saini, 2010b. Detection of PQ events using demodulation concepts: A case study. Int. J. Nonlinear Sci., 13: 64-77.
- 13] Kapoor, R. and M.K. Saini, 2011b. PQ events classification and detection-A survey. Proceedings of the International Conference on Sustainable Energy and Intelligent Systems, Jul. 20-22, IEEE Xplore Press, Chennai, pp: 490-495. DOI: 10.1049/cp.2011.0412