



## Structural Analysis of IC Engine Piston Head for Optimum Convex Shape

Mr.Subramanyam Jeevan Babu<sup>1</sup>, Dr. G.Maruthi Prasad Yadav<sup>1</sup>, Mr.V.Chengal Reddy<sup>1</sup>, Mrs.T.Nishkala<sup>1</sup>.

<sup>1</sup>Dept. of Mechanical Engg., Chadalawada Ramanamma Engineering College(Autonomous), Tirupati, Andhra Pradesh 517506, India.

**Abstract:** The top face of cylindrical piston influences the effectiveness of the engine efficiency by transmitting the maximum portion of power generated with minimum losses. Thus in this work, it is proposed to analyze the performance of the piston, by providing convex shape to the piston head with different radii of curvature.

The piston is designed numerically and then the model is created in Catia V5 software, which further is analyzed using Ansys 15.0 software to study the equivalent von-mises stress distribution and deformation development and safety factor attained.

The structural analysis is carried with series of the piston models with different radii of convex shaped head and comparison was carried among all the models and also with the piston model with flat head shape to find the optimum head shape of the piston for effective performance.

**Index Terms - Convex Shape, Piston Head, Structural Analysis.**

### I. INTRODUCTION

Piston is a reciprocating component in an engine which converts the chemical energy after the burning of fuel into mechanical energy. The purpose of the piston is to transfer the energy to crankshaft via connecting rod. The piston is to be strong but its weight should be less to prevent inertia forces due to reciprocating motion. To reciprocate in the cylinder provide seal in suction, compression, expansion and exhaust stroke

### II. OBJECTIVES

Piston should be strong enough to withstand the pressure build up and elevated high temperature in the engine cylinder due to combustion process. Thus in this work an attempt is made to study the stability of the piston for both pressure load and temperature exposure on the piston head by providing convex shape with different radius of curvature.

### III. DESIGN OF THE PISTON

$D=73\text{mm}$

Stroke=  $l_s = 71.5\text{mm}$

Power = 61894Watts at  $N=6000\text{rpm}$

Power =  $p.l_s.a_c.n/60$   
 $= p.l_s.a_c.N/(2X60)$

Here  $a_c = 4.\pi.D^2/4 = 0.0168\text{m}^2$

Therefore, pressure,  $p = 1.04\text{N/mm}^2$

**Thickness of Piston Head ( $t_H$ ):** The piston thickness of piston head calculated using the following Grashoff's formula.

$$t_H = \sqrt{\frac{3pD^2}{16\sigma_t}}$$

Here,  $\sigma_t = \text{Allowable stress} = 276\text{N/mm}^2$

Therefore, by considering  $FS=2$ , we got  $t_H = 7.76\text{mm} \cong 8\text{mm}$

**Radial Thickness of Ring ( $t_1$ ):**

$$t_1 = D.\sqrt{\frac{3p_w}{\sigma_t}}$$

Here  $p_w = \text{Allowable pressure on cylinder walls} = 0.042\text{N/mm}^2$

Therefore  $t_1 = 1.55 \cong 1.7\text{mm}$

**Radial Thickness of Ring ( $t_2$ ):**

$t_2 = 0.7t_1$  to  $t_1 = 1.19$  to  $1.7\text{mm}$

or

$t_2 = D/(10.n_r)$

$n_r = \text{number of piston rings} = 4$  (consider)

Therefore,  $t_2 = 1.82$

So finally taking higher value  $t_2 = 1.82\text{mm}$

**Width of the Top Land ( $b_1$ )**

$$b_1 = t_H \text{ to } 1.2 t_H \\ = 8\text{mm to } 9.6\text{mm} \quad = 9\text{mm}$$

**Width of other Lands ( $b_2$ )**

$$b_2 = 0.75 t_2 \text{ to } t_2 = 1.365\text{mm to } 1.82\text{mm} \quad = 1.7\text{mm}$$

**Maximum Thickness of Barrel ( $t_3$ )**

$$t_3 = 0.03D + b + 4.5 = 8.8\text{mm}$$

Where,  $b$  = radial depth of piston ring groove.  $b = t_1 + 0.4$

**Piston Wall Thickness towards the Open End ( $t_4$ )**

$$t_4 = 0.25t_3 \text{ to } 0.35t_3 = 0.425 \text{ to } 0.595\text{mm}$$

**Piston Skirt length( $l$ )**

Side thrust on cylinder walls is taken as  $1/10^{\text{th}}$  of maximum gas force, therefore,

$$R = p_b \cdot D \cdot l = F_c/10, \text{ here } F_c = p \cdot \pi \cdot D^2/4$$

Therefore by taking  $p_b$  (bearing pressure capacity as  $0.5\text{N/mm}^2$ ),

$$l = 11.9\text{mm}$$

Total length of piston,  $L = l + l_r + b_1$

$$l_r = \text{length of ring section} = n_r \cdot t_2 + (n_r - 1) \cdot b_2 = 12.38\text{mm}$$

Therefore,  $L = 43.3\text{mm}$

**Piston pin diameter ( $d_i$  and  $d_o$ )**

$$\text{Maximum gas pressure} = p_{b1} \cdot d_o \cdot l_1$$

Taking

$$l_1 = 0.45D$$

$$p_{b1} = \text{allowable bearing pressure} = 25\text{N/mm}^2$$

$$d_o = 5.1\text{mm}$$

$$d_i = 0.6 d_o = 3.05\text{mm}$$

**IV. MODELING OF PISTON**

The step by step procedure followed in creating the model of piston is shown in the following figures.

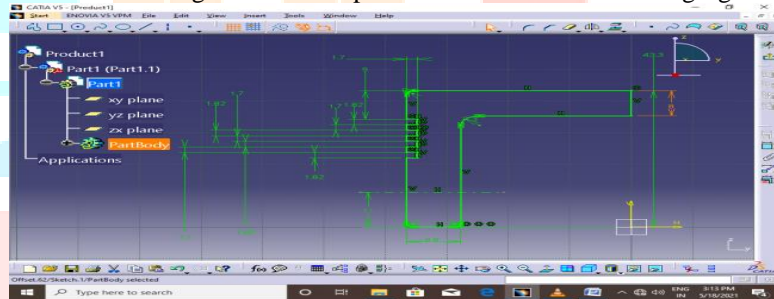

Fig 4.1: Basic line sketch of piston

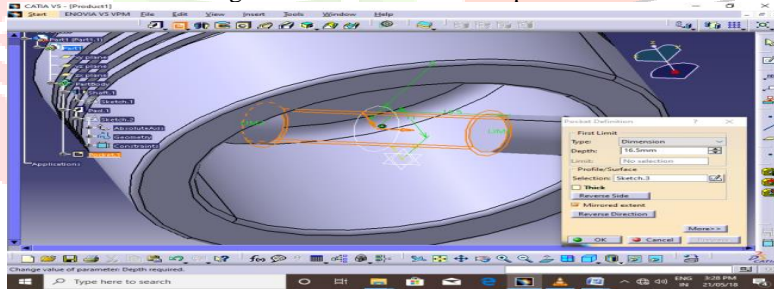

Fig 4.2 Creating piston pin bosses

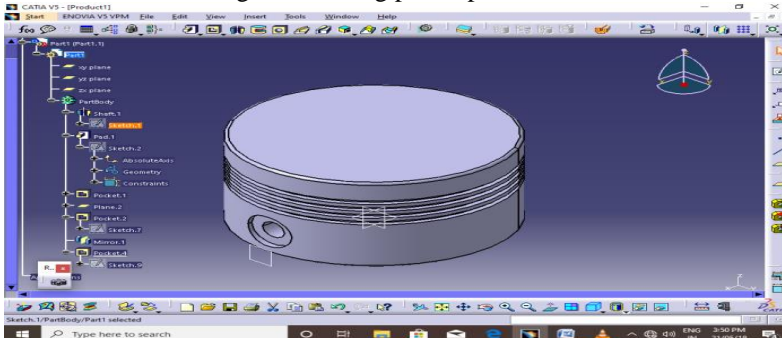

Fig 4.3 Final piston model-I created with flat head

Similarly the other five more models were created using Catia V5 as follows

Model-I: Piston with flat Head

Model-II: Piston with 250mm radius of curvature of convex shaped head

Model-III: Piston with 200mm radius of curvature of convex shaped head

Model-IV: Piston with 150mm radius of curvature of convex shaped head

Model-V: Piston with 100mm radius of curvature of convex shaped head

Model-VI: Piston with 80mm radius of curvature of convex shaped head

The following figures show the sample of creation of piston model with convex shape head.

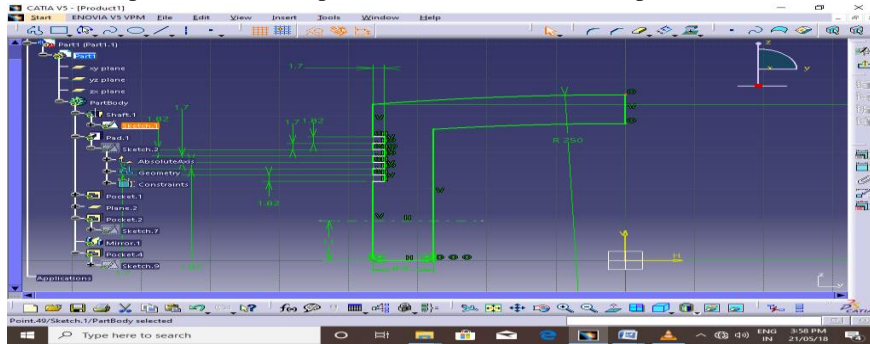

Fig 4.4: Sketch showing model with convex shaped piston head

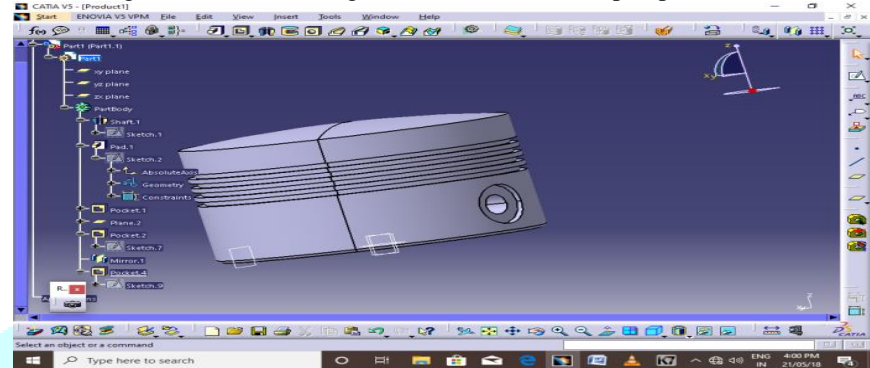

Fig 4.5: Piston Model-II created using Catia V5

**V. V. ANALYSIS OF PISTON**

**5.1 Step by Step Structural Analysis Procedure (Piston Model-I with Flat Head Surface)**

Step 1: At first the ansys structural analysis is to be loaded as shown in following figure. Then the material required is selected as shown in fig 5.1.

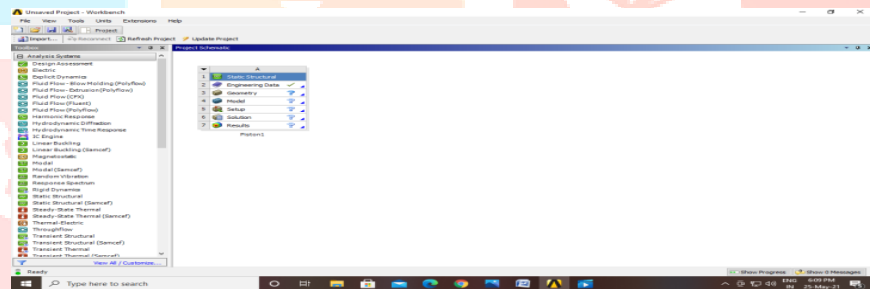

Fig 5.1: Starting of structural analysis in Ansys 15.0

Step 2: The Catia model is to be imported in igs format as shown in fig 5.2

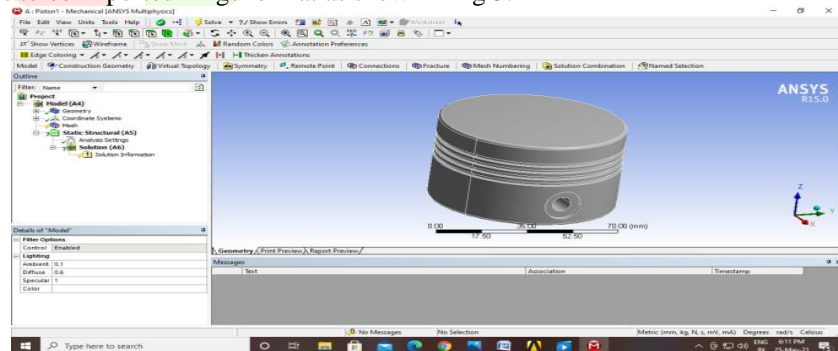

Fig 5.2: Catia model imported to Ansys 15.0

Step 3: The model is divided in finite parts and meshed model is as shown in fig 5.3

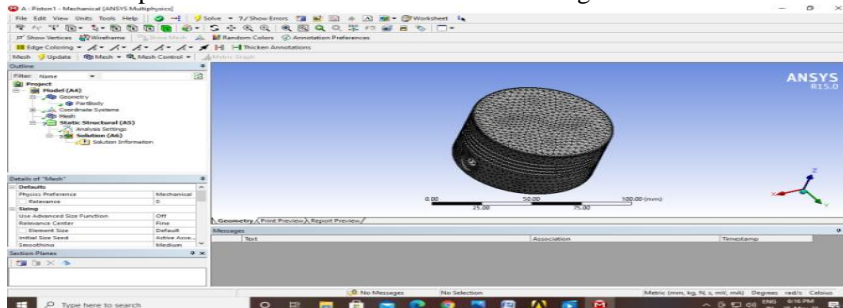

Fig 5.3: Meshed model of piston in Ansys15.0

Step 4: The fixed constraints are applied as shown in fig 5.4.

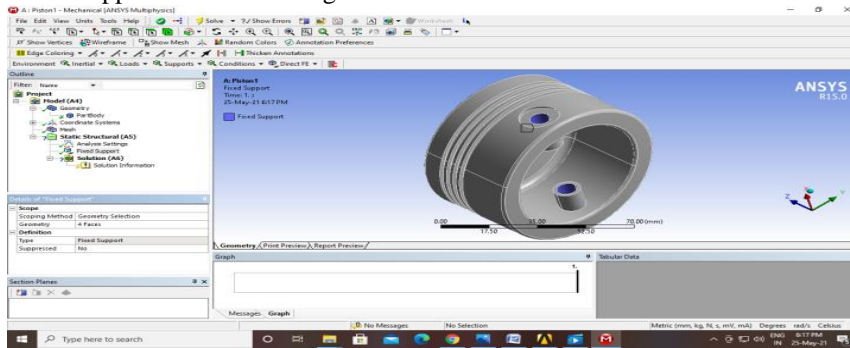

Fig 5.4: applying fixed constraints at the piston pin bosses in Ansys15.0

Step 5: The loading is applied at the small end of connecting rod as shown in fig 5.5.

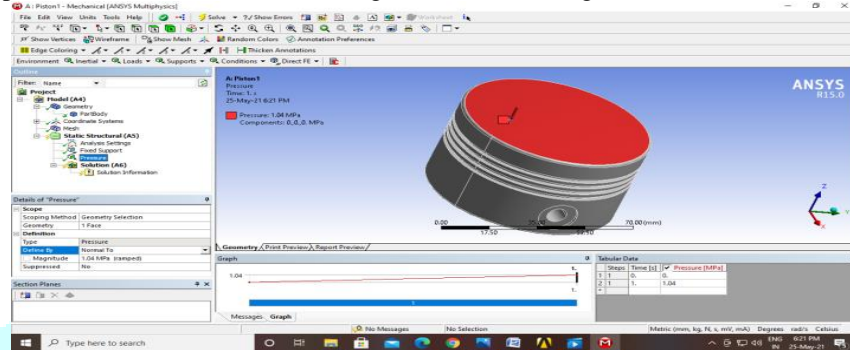

Fig : 5.5 Load application on the head of piston in Ansys 15.0

Step 6: Then to solve the problem using solver option as shown in fig 5.6.

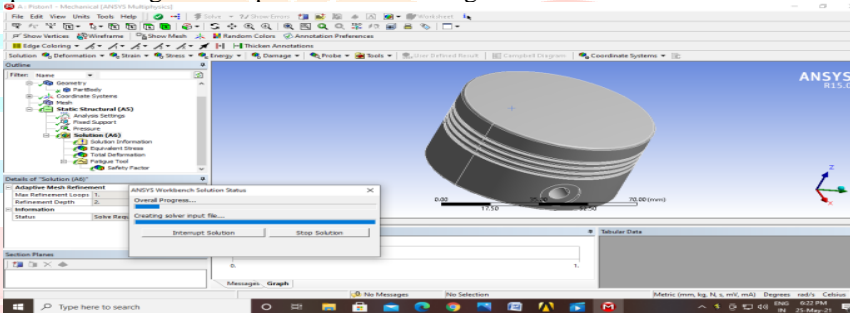

Fig: 5.6: Problem solving in Ansys 15.0

The results of structural Analysis are discussed in detail in the next section

## VI. VI. RESULTS AND DISCUSSION

### 6.1 Structural Analysis of Piston Models

#### 6.1.1 Analysis Results of Piston Model-I

The following fig 6.1 shows the equivalent von-mises stress distribution in the piston model-I (Flat piston head). The results reveal that the stress intensity is higher at the center of piston head and decreases towards radial outside. This is as usually expected due to supported at the outer edge along the circumference of piston head, which satisfies the results which generally obtains through theoretical method of solving. The color representation in the resulting diagrams shows that the stress distribution is not uniform in radial outward direction in all 360 degrees, it shows that the stress intensity is less in along the direction of axis of the piston pin when compared to its transverse direction. Therefore, it is clear from the resulting diagram that ribs support if needed, care to be taken more on the transverse direction to the axis of piston pin direction for achieving uniform stress distribution on the piston head surface. But at the same time it is observed that the maximum stress intensity developed is not on the piston head surface and it was found to be developed at the piston pin bosses with red color representation. The maximum stress developed at the center of piston head surface was found to be represented with green color, which indicates that the maximum stress intensity is in between 11 to 15N/mm<sup>2</sup>, whereas, the maximum intensity is found to be 26.986N/mm<sup>2</sup>, developed at the bosses of piston pin. Therefore care should be taken in the design of piston pin bosses.

The following fig 6.2 shows the deformation developed in the piston model-I with flat head surface. The resulting image shows the color pattern of deformation between minimum of 0mm to maximum of 0.013366mm. The result reveals that the pattern of distribution is similar to the stress distribution. The deformation along the direction of the axis of the piston pin is less than that of its transverse direction. In addition to the piston head surface, if the side wall surface of piston shows the similar trend with green color pattern in transverse direction of piston pin and dark blue to light blue along the axis of piston pin. This shows that the deformation on the side walls of piston also showing the same trend as on the head surface. This trend is desired, because the piston leads to side thrust of cylinder walls due to tilting of connecting rod from the axis of piston, therefore with this pattern of deformation clears that the deformation along the transverse direction is less, but at the same time an addition deformation takes place in longitudinal direction of piston pin due to side thrust. Thereby the deformation will come to a close uniform distribution throughout the circumference.

The following figure 6.3 shows the safety factor of piston model-I with flat head surface. The resulting diagram shows that the safety factor is in the range of 3.066 to 15. The critical safety factor is 3.066, which occurs at the bosses of the piston pin. Prominently the bosses of piston pin and center of piston head are under lower safety factor; therefore care should be taken in

these areas to improve their strength by providing additional dimensions than what obtains in design calculations. But still the created model is almost more than 3 times safer at the considered loading condition.

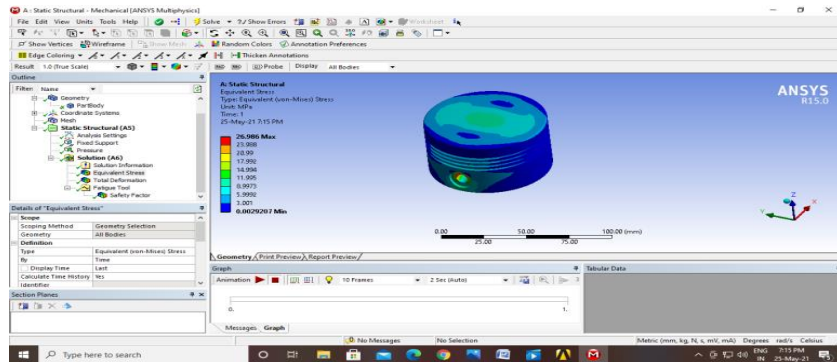

Fig 6.1 Von-mises stress distribution in piston model-I in Ansys 15.0

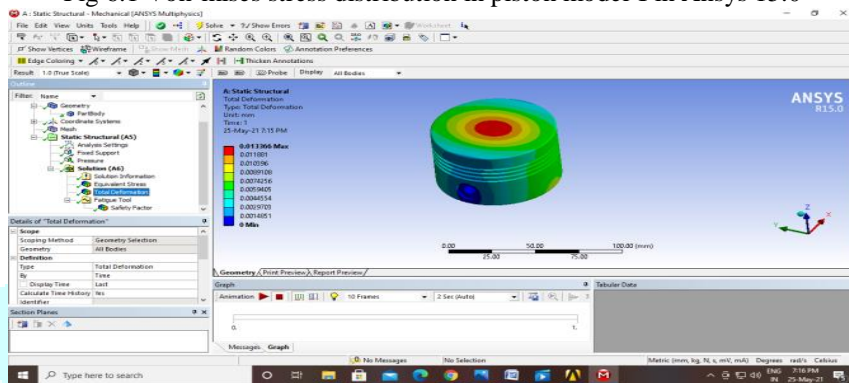

Fig 6.2 Deformation developed in piston model-I in Ansys 15.0

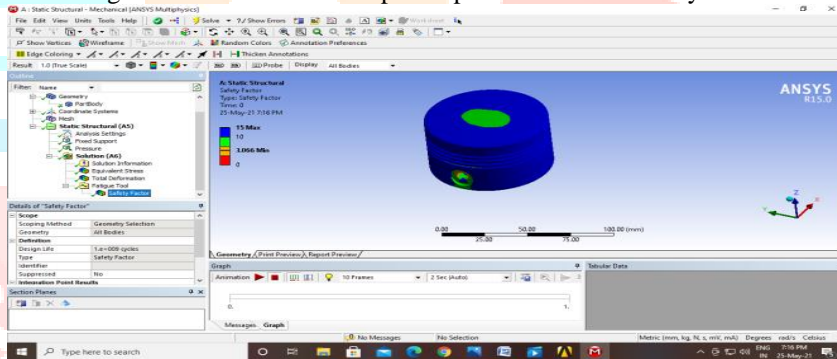

Fig 6.3 Safety factor occurred in piston model-I in Ansys 15.0

### 6.1.2 Analysis Results of Piston Model-II

The following fig 6.4 shows the von-mises stress distribution in the piston model-II provided with convex shape head of radius 250mm. The resulting image shows that the pattern of distribution of stress is similar to that of the model-I, but the intensity got reduced with a maximum stress intensity of 25.123N/mm<sup>2</sup>. By observing the resulting image from internal side, it was understood that the stress distribution got reduced at the inner surface of piston head. This is due to that convex shaped head shape which reduces the component of force acting on piston head due to pressure inside the combustion chamber. It means that in the previous case the force due to combustion directly acts normal to the piston head surface, whereas now by providing the convex shape the force acts at some inclination to that convex shaped surface, thereby the normal component acting on piston head surface decreases and the tangential component makes the force to transmit towards the supported edges of head.

The following figure 6.5 shows the deformation developed in piston model-II provided with convex shaped head of radius 250mm. The resulting color image shows the same pattern as that of stress distribution. The maximum deformation of 0.012047mm was developed at the center of head of piston. Though the pattern is same as that of deformation distribution in model-I, it is slightly varies with wide range of distribution along the transverse direction on head and side vertical surfaces, which represents that the load is distributed circumferentially. Thus load bearing capacity of piston provided with convex shaped head increases.

The following figure 6.6 shows the safety factor occurred at all the areas of piston model-II. The result reveals that the pattern is similar to the model-I, but it follows the trend of stress distribution of model-II with a minimum of 3.2934, which arises at the bosses of piston pin. This results giving an idea of providing lining bush like structure at the bosses further to strengthen the same.

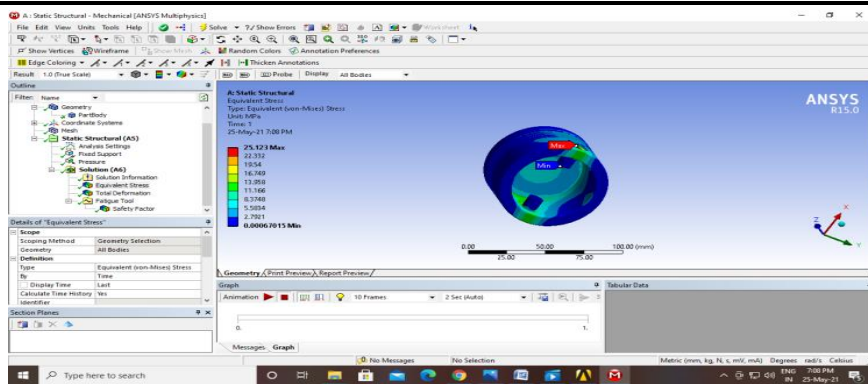

Fig 6.4 Von-mises stress distribution in piston model-II in Ansys 15.0

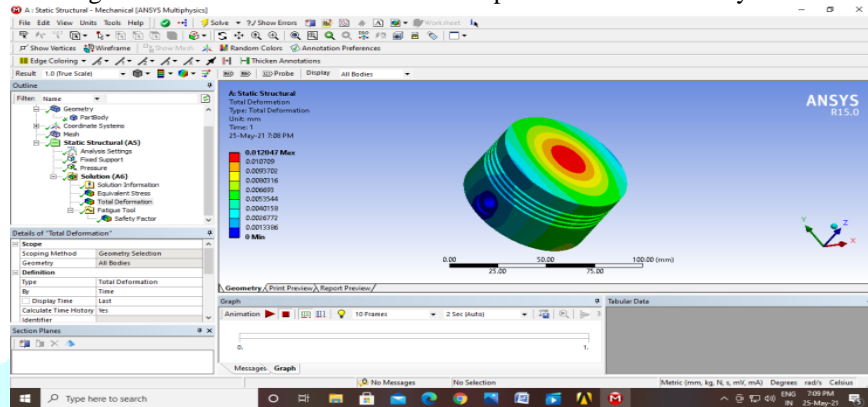

Fig 6.5 Deformation developed in piston model-II in Ansys 15.0

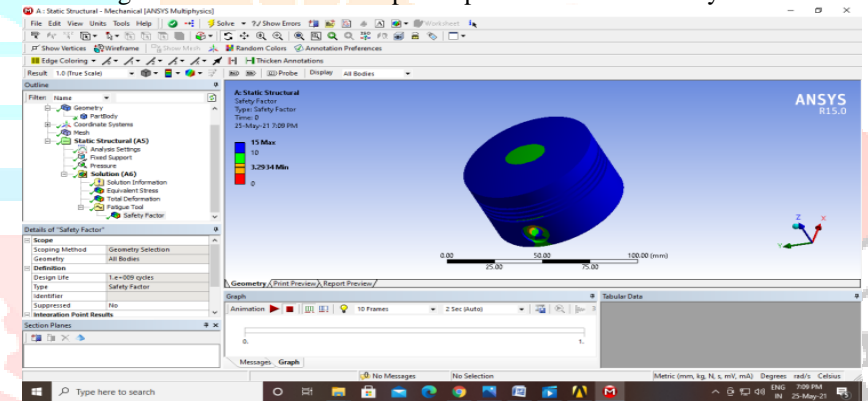

Fig 6.6 Safety factor occurred in piston model-II in Ansys 15.0

### 6.1.3 Analysis Results of Piston Model-III

The following figure 6.7 shows the von-mises stress distribution in piston model-III, provided with convex shaped head of radius 200mm. The color image of result reveals that though the pattern of distribution of stress is similar to the previous model, the stress intensity decreases further with increase of radius of curvature of convex head. The maximum stress intensity of  $23.219\text{N/mm}^2$  is found to be developed at the bosses of the piston. The maximum stress in this model is 7.58% lower than the maximum intensity of model-II and 13.96% lower than that of the model-I. This clearly represents that the convex shaped head surface assists in load distribution on the piston, which improves the effectiveness of piston.

The following figure 6.8 shows the deformation arise in the piston model-II, provided with convex shaped head of radius 200mm. The deformation pattern of development in this model is similar to the previous model-II, with further improvement in distribution of load in transverse direction of axis of piston pin, which can be observed with moderate deformation development on head surface and as well as side vertical surface with green color representation. The maximum deformation develops at the center of piston head with  $0.010954\text{mm}$ . Thus the maximum deformation in this model-III is 9.07% lower than that of deformation in model-II and is 18.5% lower than that of in model-I. This is tremendous results as predicted with higher performance of piston.

The following fig 6.9 shows the safety factor occurrence in the piston model-II, provided with convex shaped head of radius 200mm. The pattern of factor of safety arise is similar to the previous models with minimum of 3.5634 obtained at piston bosses and moderate value in the range of 5 to 10 at the center of piston head surface. The factor of safety in this model-III is 8.19% higher than that of model-II and 16.22% higher than that of model-I. So this model-III is higher safer than that of remaining two previous models.

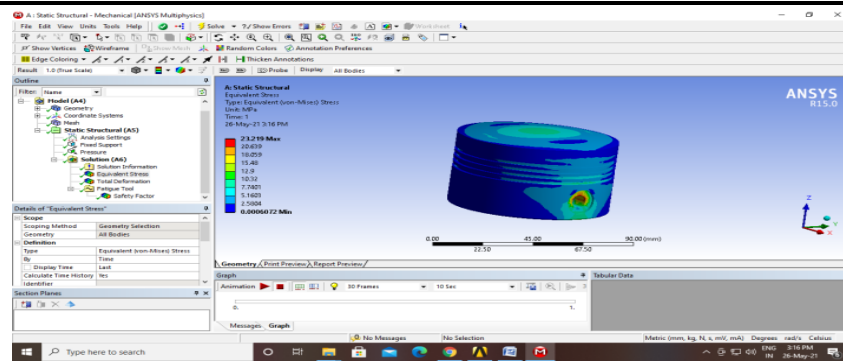

Fig 6.7 Von-mises Stress distribution in Piston Model-III in Ansys 15.0

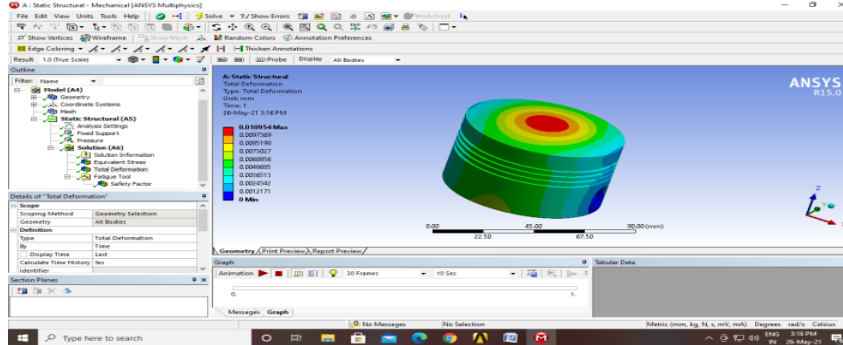

Fig 6.8 Deformation developed in piston model-III in Ansys 15.0

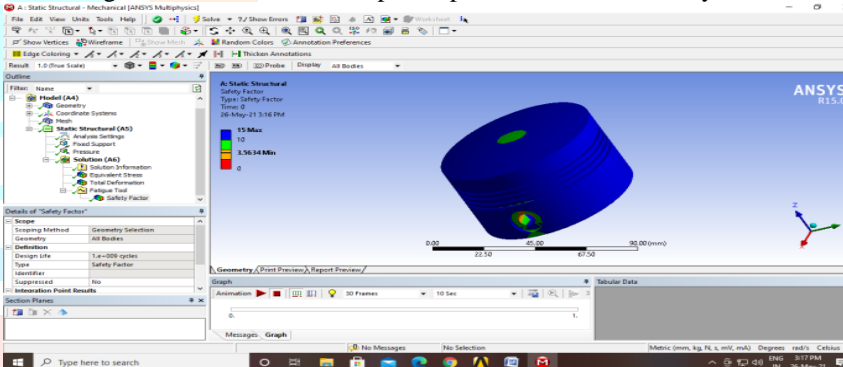

Fig 6.9 Safety factor occurred in piston model-III in Ansys 15.0

**6.1.4 Analysis Results of Piston Model-IV**

The following fig 6.10 shows the von-mises stress distribution in piston model-IV, provided with convex shaped head of radius 150mm. The pattern of distribution is similar to the previous models with maximum of  $25.297\text{N/mm}^2$ . There is again increase in the stress intensity in this model-IV, may be because of reduction of length of the piston to compensate the increase of height of due to convex shaped head. Thereby even there is reduction in the normal force acting over the head surface, maybe because of reduction of height of piston result in decrease in its strength. The maximum stress developed in this model-IV is 6.26% lower than that of stress in model-I, which shows this model is superior to model-I. But at the same time the maximum stress in this model-IV is 8.95% higher than that of stress in model-III.

The following fig 6.11 shows the deformation developed in piston model-IV, provided with convex shaped head of radius 150mm. The color image of result reveals that the pattern of deformation development is similar to the previous model, but the deformation is again slightly increased compared to previous model-III. The maximum deformation is developed at the center of piston head with a value of 0.011566mm. This deformation in this model-IV is 13.47% higher than that of the deformation developed in the model-I. But at the same time the deformation in this model is 5.59% higher than that of the model-III.

The following figure 6.12 shows the safety factor occurrence in the piston model-IV. The resulting image reveals the same pattern as that of previous models with a minimum of 3.2708 obtained at piston pin bosses and moderate value in the range of 5 to 10 at the center of piston head. The safety factor in this model-IV is 6.68% higher than that of critical safety factor of model-I. But at the same time the safety factor of this model-IV is 8.21% lower than that of the previous model-III.

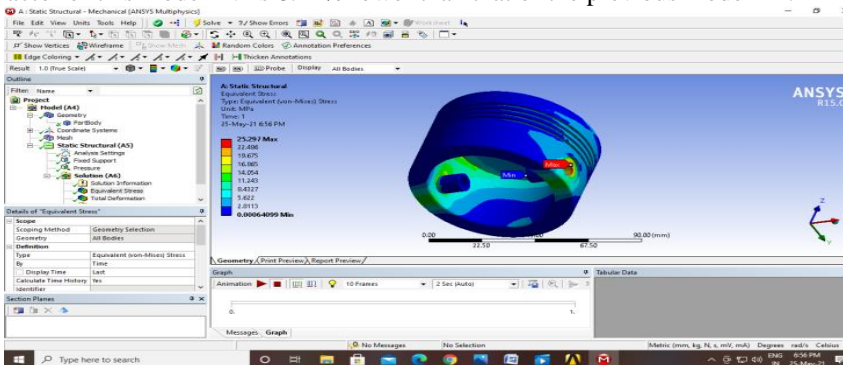

Fig 6.10 Von-mises Stress distribution in Piston Model-IV in Ansys 15.0

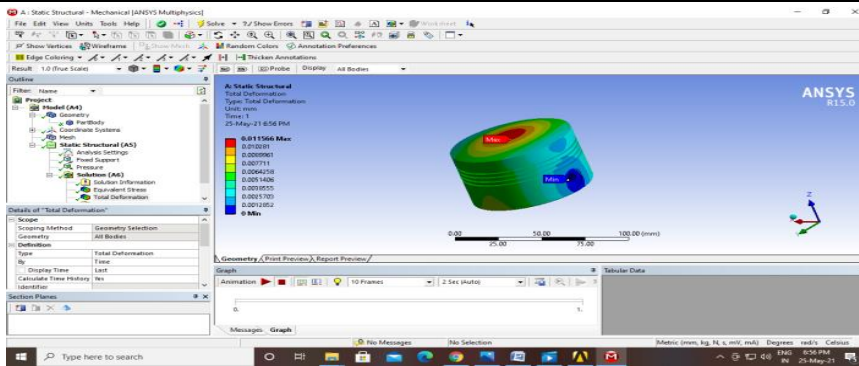

Fig 6.11 Deformation developed in piston model-IV in Ansys 15.0

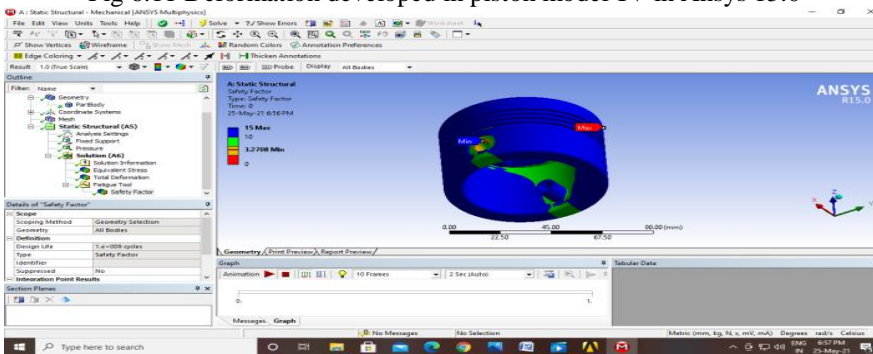

Fig 6.12 Safety factor occurred in piston model-IV in Ansys 15.0

**6.1.5 Ansys Results of Piston Model-V**

The following fig 6.13 shows the equivalent von-mises stress distribution in piston model-V provided convex shaped head of radius 100mm. The pattern of stress distribution in this model is similar to that of previous models, but the stress intensity has been increased, compared with the previous models. The maximum stress developed in this model is 30.34N/mm<sup>2</sup>. The maximum von-mises stress intensity in this model-V is 12.4% higher than that of piston model-I and 21.72% higher than that of model-III.

The following fig 6.14 shows the deformation developed in the piston model-V, provided with 100 radius of curvature of convex shape head. The pattern of development of deformation is similar to the previous models, but the effectiveness of piston decreases, showing higher deformation in this model. The maximum deformation in this model is 1.6% higher than that of the piston model-I and is 2.25% higher than that of deformation in model-III.

The fig 6.15 shows the safety factor arise in the piston model-v, provided with 100mm radius of curvature of convex head. The pattern of occurrence of safety factor in this model is similar to the previous models with a critical value of 2.7271 at the piston bosses and in the range of 5 to 10 at the center of piston head. The results reveal that the strength of this model-V lower than that of remaining all the previous models.

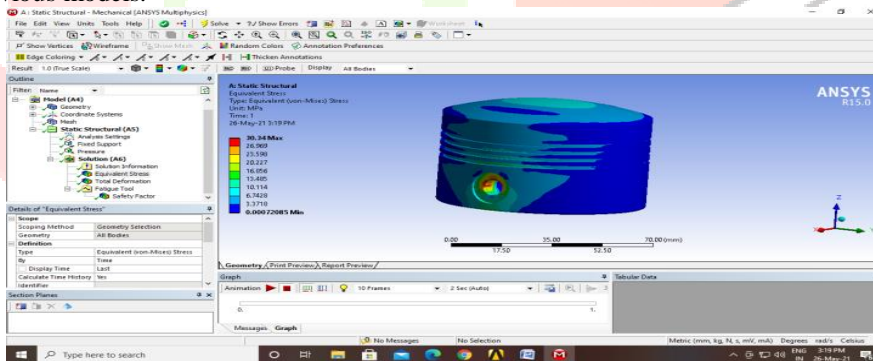

Fig 6.13 Von-mises Stress distribution in Piston Model-V in Ansys 15.0

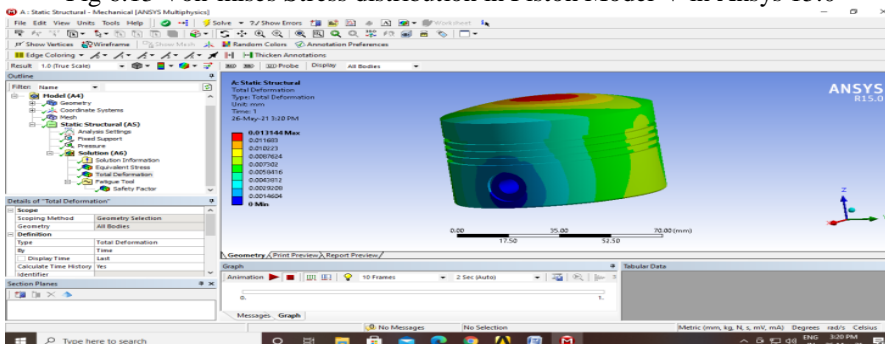

Fig 6.14 Deformation developed in piston model-V in Ansys 15.0



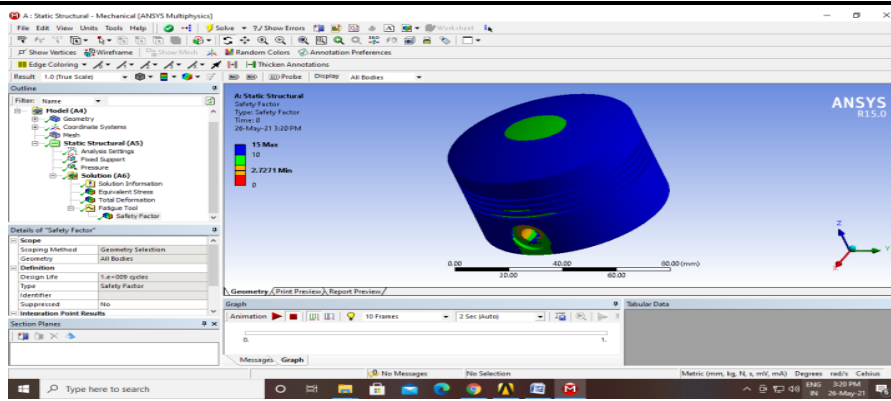

Fig 6.15 Safety factor occurred in piston model-V in Ansys 15.0

**6.1.6 Ansys Results of Piston Model-VI**

The fig 6.16 shows the von-mises stress distribution the piston model-VI with 80mm radius of curvature piston head. The results reveal that the stress intensity increases in this model compared to all the remaining previous models with a maximum value of 32.815N/mm<sup>2</sup>. The maximum stress in this model-VI is 21.6% higher than that of stress intensity in model-I and is 41.3% higher than that of the model-III.

The following fig 6.17 shows the deformation developed in the model-VI, which reveals that the performance decreases in this model when compared with remaining all previous models. The maximum deformation of 0.013419mm is developed at the center of the piston head, which is 0.4% higher than that of model-I and 22.5% higher than that of the model-III.

The following fig 6.18 shows the safety factor occurred in the piston model-VI. The pattern of occurrence shows that it is similar to the previous models, but this not superior compared to the previous models with a critical safety factor of 2.5214, which arise at piston bosses and this safety factor is 17.7% lower than that of model-I and 29.24% lower than that of model-III.

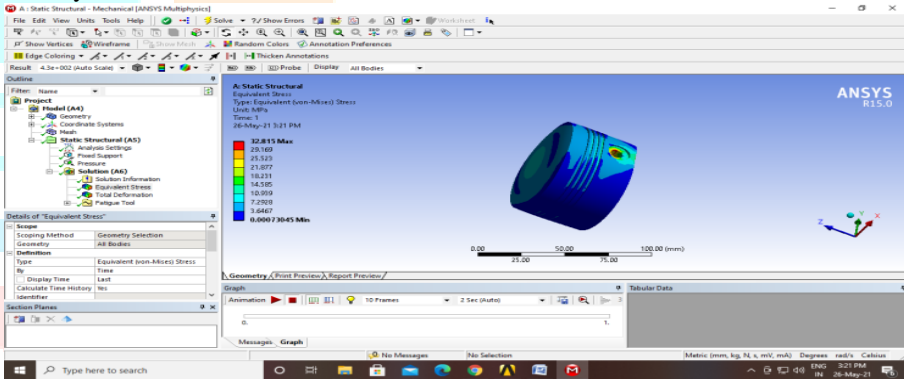

Fig 6.16 Von-mises Stress distribution in Piston Model-VI in Ansys 15.0

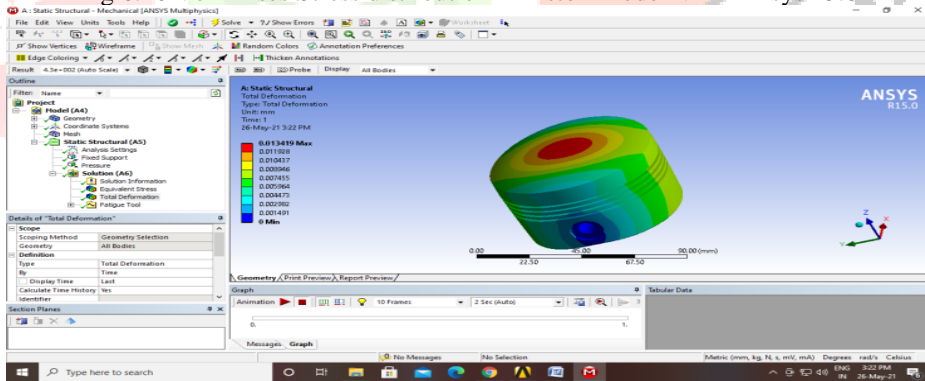

Fig 6.17 Deformation developed in piston model-VI in Ansys 15.0

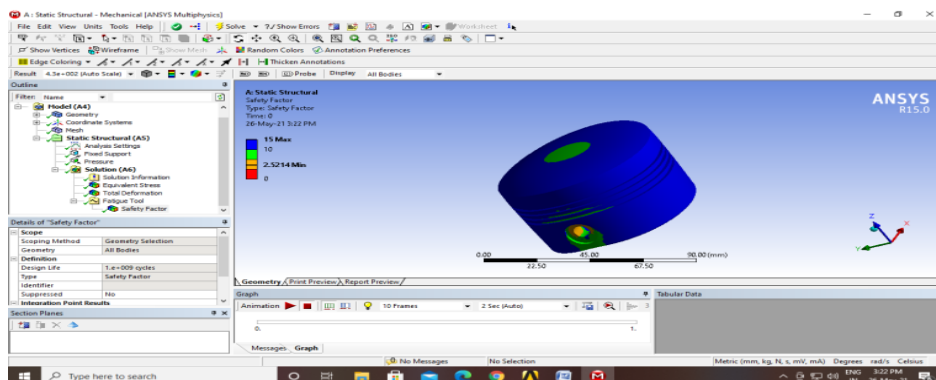

Fig 6.18 Safety factor occurred in piston model-VI in Ansys 15.0

### 6.1.7 Comparison of stress, deformation and safety factors of all piston models analyzed.

The following fig 6.19 shows the comparison of maximum von-mises stress developed in all the models, shows that the stress intensity decreases from model-I to model-III and again further increases up to model-VI. This shows that model-III is superior with lower stress intensity.

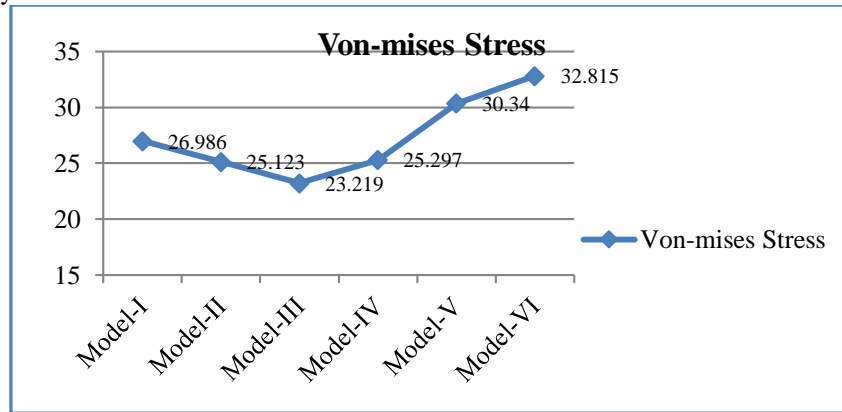

Fig 6.19 : Comparison of Maximum Von-mises stress developed in all the models

The following fig 6.20 shows the comparison of maximum deformation developed in all the piston models. The graph shows that the deformation decreases from model-I to model-III and further increase up to model-VI.

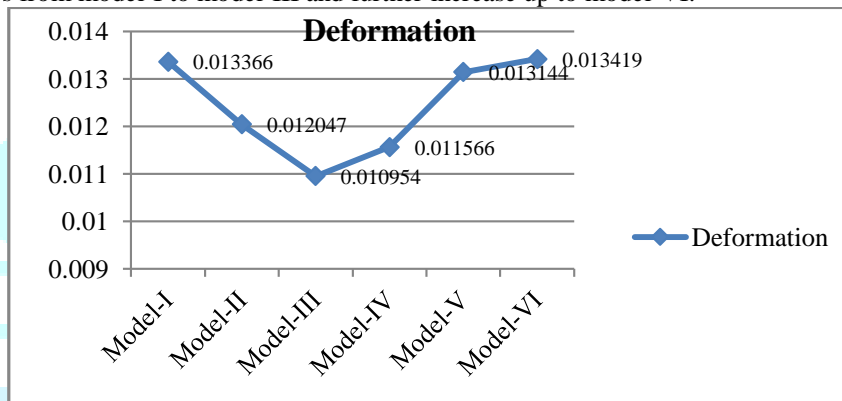

Fig 6.20 : Comparison of Maximum deformation developed in all the models

The following graph 6.21 shows the comparison of critical safety factor of all the piston models, which shows that the safety factor increases from piston model-I to model-III and again further decreases up to model-VI.

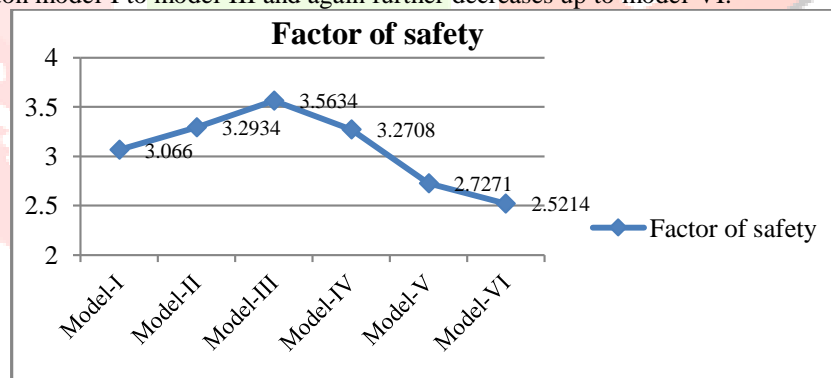

Fig 6.21 : Comparison of critical safety factors developed in all the models

## VII. CONCLUSIONS

The following conclusions were drawn by carrying structural analysis tests on series of piston models with different radius of curvature of convex shaped head.

- The maximum equivalent stress developed is highest in the piston model-VI, which is provided with 80mm radius of curvature of convex shaped head with an intensity of 32.815N/mm<sup>2</sup>.
- The maximum deformation developed is highest in the piston model-VI, which is provided with 80mm radius of curvature of convex shaped head with a magnitude of 0.013419mm
- The lowest critical safety factor of 2.5214 is developed in the piston model-VI, which is provided with 80mm radius of curvature of convex shaped head.
- The maximum equivalent stress developed is lowest in the piston model-III, which is provided with 200mm radius of curvature of convex shaped head with an intensity of 23.219N/mm<sup>2</sup>.
- The maximum deformation developed is lowest in the piston model-III, which is provided with 200mm radius of curvature of convex shaped head with a magnitude of 0.010954mm
- The highest critical safety factor of 3.5634 is developed in the piston model-III, which is provided with 200mm radius of curvature of convex shaped head.
- The maximum stress in the piston model-III is 7.58% lower than the maximum intensity of model-II and 13.96% lower than that of the model-I.

- Thus the maximum deformation in this piston model-III is 9.07% lower than that of deformation in model-II and is 18.5% lower than that of in model-I.
  - The factor of safety in this model-III is 8.19% higher than that of model-II and 16.22% higher than that of model-I.
- Thus, considering the structural analysis, the piston model-III, provided with 200mm radius of curvature of convex shaped head is superior compared to all the models.

## REFERENCES

- [1] A.Nandha Kumar, Adhithyan.V, Pranav Hemachandran, P.Raj Kumar, Mr.J.Manikandan (2019), Review Paper On Design And Analysis Of Ic Engine Piston With Different Material, International Journal of Management, Technology And Engineering, Volume IX, Issue I,pp 208- 214
- [2] Mr.K.Sivaramakrishnan, G.Jithendra, V. Ajithkumar (2019), Design and Analysis of Four Stroke Engine Piston, International Journal of Engineering Science and Computing, Volume 9 Issue No.2,pp 19743-19746
- [3] S.Sakthivel, Dr.K.Rajkumar (2018), Design And Analysis Of A Piston By Material Optimization, International Journal of Innovative Research in Technology, Science & Engineering, Volume – 4, Issue – 3. Pp 24-28
- [4] Mr.SajidTamboli,Dr.N.K.Nath, Dr.S.B.Satpal (2018), Design And Analysis of Gudgeon pin, IOSR Journal of Mechanical and Civil Engineering, PP. 38-41
- [5] SubodhKumar,C. S. Koli (2018), A Review Paper on Thermal Analysis of Piston by Finite Element Analysis, International Journal for Scientific Research & Development| Vol. 5, Issue 12,pp 657-661
- [6] Prashant M. Sagare, Aditya Arvind Yadav, SonalManglekar, AnamikaMahadev Pol, JayashriMalpeddi (2018), Finite Element Analysis of Piston using Aluminum Alloys on Ansys, International Journal of Science Technology & Engineering, Volume 4, Issue 7,pp 8-12
- [7] G. Manusha , G. Kavya , K. S. J. Sadhana, Naseer Ahmed, Sd. Inthiyaz , T. Harish Babu (2018), Design And Analysis of IC Engine Piston, Piston Rings and Connecting Rod, International Journal of Advanced Technology and Innovative Research, Vol.10,Issue.04, Pp 0342-0347
- [8] Yenugupalli Anil Kumar,A.Sridhar Reddy (2017), Design and Analysis of Modular Piston by Using Couple Field Analysis, International Journal for Modern Trends in Science and Technology, Volume: 03, Issue No: 11,pp 42-49
- [9] Anup Kumar Shetty, Abijeet TK, James William Machado, Shrivathsa TV(2017), Design and Analysis of Piston using Aluminium Alloys, International Journal of Innovative Research in Advanced Engineering, Issue 04, Volume 4,pp 1-6
- [10]Gadde Anil Kumar, Chandolu Nehemya Raj (2017), Design And Analysis Of An Ic Engine Piston And Piston Rings By Using Three Different Materials, International Journal of Advances in Mechanical and Civil Engineering, Volume-4, Issue-2,pp 20-25
- [11]Vishal Kumar Shrivastava, Alok Agrawal (2017), Thermal Analysis of a Diesel Piston with different material parameter, International Journal of Advanced Scientific and Technical Research Issue 7 volume 2,pp 214-225
- [12]Dipayan Sinha, SusenjitSarkar,Samar Chandra Mandal(2017), Thermo Mechanical Analysis of a Piston with Different Thermal Barrier Coating Configuration, International Journal of Engineering Trends and Technology ,Volume 48 Number 6,pp 335-349
- [13]P.Viswabharathy, N.Jeyakumar, P.kannan, A.Vairamuthu (2017), Design and Analysis of Piston in Internal Combustion Engine Using ANSYS, International Journal of Emerging Technologies in Engineering Research, Volume 5, Issue 3,pp 62-70