



## Application of DInSAR Technique to High Coherence Sentinel-1 Images for Deformation Monitoring and Result Validation

<sup>1</sup>Nagashree Arun M, <sup>2</sup>Nayana G Naik, <sup>3</sup>K Thrishul, <sup>4</sup>Jagath Haren, <sup>5</sup>Reena Lobo

<sup>1,2,3,4,5</sup> Student, <sup>2</sup> Student, <sup>3</sup> Student, <sup>4</sup> Student, <sup>5</sup> Assistant Professor

<sup>1,2,3,4,5</sup> Department of Computer Science and Engineering

<sup>1,2,3,4,5</sup> Alva's Institute of Engineering and Technology

**Abstract:** Deformation monitoring represents a crucial issue in order to avoid catastrophic failures due to infrastructure aging or earthquake damages. Differential SAR Interferometry (DInSAR) is a technique suitable for critical infrastructure monitoring, also for the availability of free data and tools that can be used by experts in SAR remote sensing and also by geologists and civil engineers, after having acquired the right confidence and experience in these data processing and tool use. In order to apply the DInSAR technique, in its basic and simple version, to critical infrastructure monitoring, it is very important to assess its performance. Nevertheless, validation results are not largely available in literature, because heterogeneous technical competencies are required to this aim and in situ measurements must be collected and made available. In this paper, we propose a highly reproducible DInSAR workflow that can be effectively used for deformation monitoring, by validating its results with in situ measurements.

**Index Terms:** Deformation monitoring, Differential Synthetic Aperture Radar Interferometry (DInSAR), geohazard assessment, image coherence, result validation, Sentinel-1.

### I. INTRODUCTION

Geohazards comprise natural geological and environmental phenomena, such as earthquakes, landslides, subsidence, and tsunamis, which may cause devastating effects on populations, territory, and economies. This long-term or short term process may significantly impact the affected territories on both local and regional scales.

Deformation monitoring (also referred to as deformation survey) is the systematic measurement and tracking of the alteration in the shape or dimensions of an object as a result of stresses induced by applied loads.

The main shortcoming of the traditional survey is represented by the reduced number of monitoring stations, which cannot assure the desired spatial density in the required information, unless prohibited operating costs and long data processing. Satellite-borne SAR Interferometry (InSAR) is an emerging technique to monitor deformation and several papers in the specific literature revolve around SAR monitoring strategies applied to earthquake deformation or both typologies.

### II. COPERNICUS PROGRAMME AND THE SENTINEL-1 MISSION

The proposed approach is based on free remote sensing data and processing tools from the European Copernicus programme and aims at developing geographical information services for environmental monitoring based on satellite remote sensing and in situ measurements.

Sentinel satellites, when specific acquisition tasks are not committed, are employed in a default continuous Earth coverage programme, in order to build an updated large global archive.

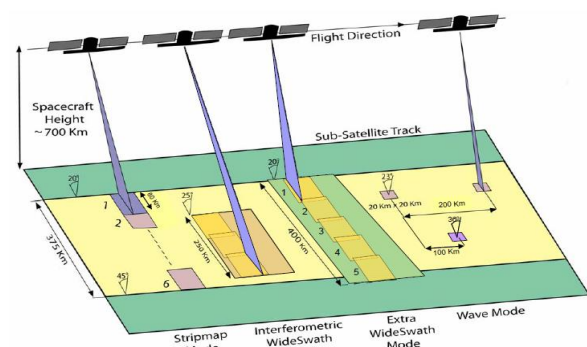

Fig 1: Sentinel-1 acquisition modes

A large earthquake can take many tens of seconds to minutes to rupture from the epicentre initiation point on the fault (hypocentre) to its eventual end, which may be many hundreds of kilometres away from the start.

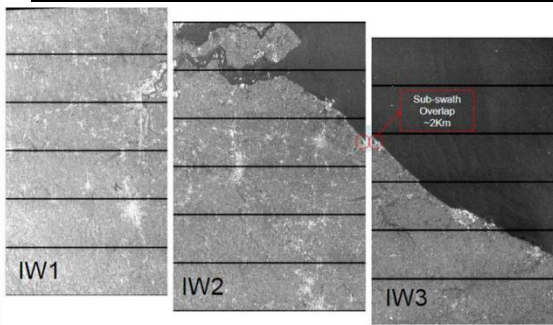

Fig. 2. Images belonging to the same Sentinel-1 IW product bundle: sub swaths and bursts.

Regarding Sentinel-1, to which we are interested for the purpose of our work, the main features concern the acquisition modes (summarized in Fig. 1): StripMap Mode, Interferometric Wide (IW) swath mode, Extra Wide swath mode, and Wave Mode. IW is the default acquisition mode over land. It captures three sub swaths using the Terrain Observation with a Progressive scans SAR (TOPSAR) technique that steers the beam both in range and in azimuth, for each burst. IW products contain one image per sub swath and one per polarization channel, in practice three (single polarization) or six (dual polarization) images. Each sub swath image consists of a series of bursts, each of them processed as a single image.

These bursts are composed in a single sub swath image with black fill demarcation in between. A small overlap among adjacent bursts provides contiguous coverage of the ground.

The Sentinel-1 data used in the paper are Level-1 SLC images acquired through the IW mode.

Data processing has been performed using the SNAP Toolbox that includes specific packages for SAR scalibration, speckle filtering, core- registration, geocoding, mosaicking, polarimetry, and interferometry. It is worth highlighting that the use of the SNAP toolbox is not straightforward, but it requires familiarity with remote sensing principles and, in particular, with SAR processing chains.

### III. DIFFERENTIAL SAR INTERFEROMETRY (DINSAR)

DInSAR is the method used to process SAR generated images and it is based on the combination of one or more pairs of satellite images whose orbital parameters are all known. The combination of two SAR images of the same scene, acquired from slightly different orbits produces the interferogram. As shown in Fig. 3, it is obtained by multiplying one image by the complex conjugate of the other and contains, on a pixel by pixel basis, the phase difference between the two acquisitions. For each acquisition, this phase difference can be exploited in combination with the orbital information, in order to derive a Digital Elevation Model (DEM) of the scene.

The amount of movement corresponding to the phase cycle is determined as:

$$\Delta r = \lambda/2$$

that half wavelength change in the range due to the deformation creates one fringe in the interferogram.

Moreover, if we consider that the radar signal travels through the atmosphere and system itself has a noise then the measured total phase difference can be presented by:

$$\Delta\phi = \Delta\phi_{\text{topo}} + \Delta\phi_{\text{def}} + \Delta\phi_{\text{atm}} + \Delta\phi_{\text{orb}}$$

1)  $\Delta\phi_{\text{d}}$  accounts for a possible displacement of the scatterer between observations.

2)  $\Delta\phi_{\text{topo}}$  represents the residual topography induced phase due to a non-perfect knowledge of the actual height profile (i.e., the DEM errors).

3)  $\Delta\phi_{\text{orb}}$  accounts for inaccurate orbital information in the synthesis of the topographic phase.

4)  $\Delta\phi_{\text{atm}}$  denotes the phase components due to the change in the atmospheric and ionospheric dielectric constant between the two master/slave acquisitions.

5)  $\Delta\phi_{\text{n}}$  accounts for decorrelation phenomena (spatial, temporal, thermal, etc.).

The main purpose of differential interferometry is to extract from the measured total phase those which caused only by the deformation events by removing or minimizing other contributing terms.

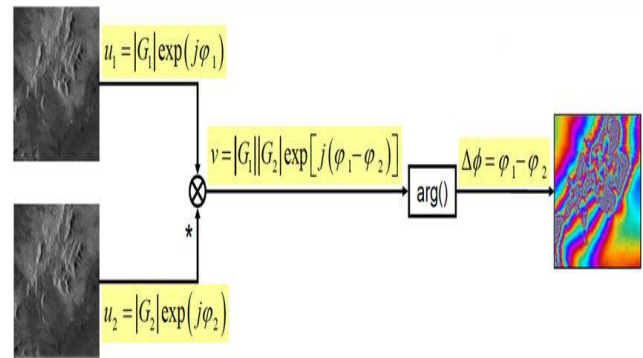

Fig 3: Interferogram is generated by multiplying two (complex) SAR images and then extracting the phase.

The contribution from the system noise is difficult to model and they are usually assumed negligible. Atmospheric influence can be suppressed by using redundant images or corrected from other sources (such as GPS). Then the main information comes from topography and deformation. Thus, if topography is known we can determine the deformation. Method with using external elevation model requires only two SAR images, assumed the deformation was occurred

#### A. Image Coregistration:

SAR interferometry requires pixel-to-pixel match between common features in SAR image pairs. Thus coregistration, the alignments of SAR images from two antennas, is an essential step for the accurate determination of phase difference and for noise reduction. The entire purpose of the coregistration is to align the samples for phase differencing. The imprecise repeat-pass geometry makes coregistration difficult, and the InSAR complex data could facilitate coregistration. The correlation window is used to search for offsets between master and slave images. After this pixel level coregistration, an interferogram may be generated, but it is not adequate for interferometric processing. The image coherence, when an interferogram must be calculated, has an important diagnostic function.

#### B. Coherence Issues:

As underlined in the previous section, the coherence among images represents a very critical issue since only high-coherence images result in a reliable interferogram. A measure of how much the two images are comparable, pixels by pixel, is given by

$$\gamma = \frac{E[u_1 u_2^*]}{\sqrt{E[u_1 u_1^*] E[u_2 u_2^*]}}$$

where  $E[\cdot]$  denotes statistical expectation,  $u_1$  and  $u_2$  represent the two images. The coefficient values range from 0 (low coherence)

to 1 (high coherence). coherence is mainly caused by geometrical and temporal decorrelations. The image coherence, when an interferogram must be calculated, has an important diagnostic function.

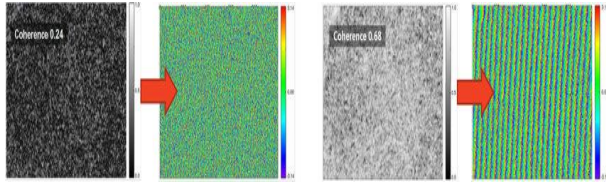

Fig 4: Examples of Interferograms from low-coherence and high-coherence images (Courtesy of ESA).

C. Phase Unwrapping for DInSAR Application:

Phase unwrapping is the process of recovering unambiguous phase values from phase data that are measured modulo 2 rad (wrapped data). Recent exciting areas of development within For a well-behaved smooth phase field, all the unwrapped phase differences between adjacent interferogram samples lie between  $-\pi$  and  $+\pi$ . When this is true, phase unwrapping is straightforward since the unwrapped phase can be evaluated by a simple (path-independent) integration of the phase differences of adjacent wrapped phases, starting from a reference location and using the assumption that all phase differences are in the interval  $(-\pi, +\pi)$ .

D. Data Processing Workflow:

The Sentinel-1 data processing is performed through the SNAP software platform. It is the pre unwrapping step, where starting from a pair of (master and slave) images, downloaded from the ESA site and imported into the SNAP environment, a series of substeps are performed. TOPSAR coregistration step is useful to split out the different sub swaths, with the relative selected bursts. Coregistration is a necessary step to match the same points on the earth surface in different images and a very stringent accuracy is needed in this case

V. RESULTS AND ANALYSIS:

As mentioned before, the aim of this paper is to validate the DInSAR results from Sentinel-1 data with on-site measurements in order to demonstrate the feasibility of integrated approaches that can improve the monitoring process of dams as well as of their surrounding areas, mainly in terms of number and location of the observed measurement points.

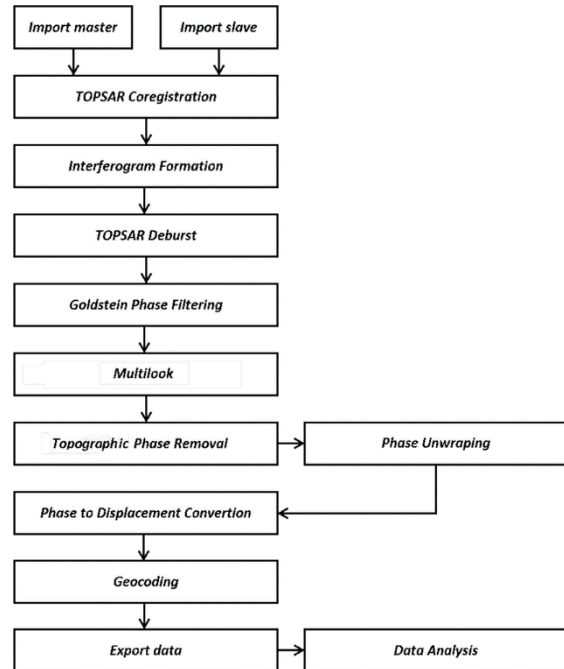

Fig 5: Workflow implemented in SNAP for the displacement map generation.

(1). Raw Input Images:

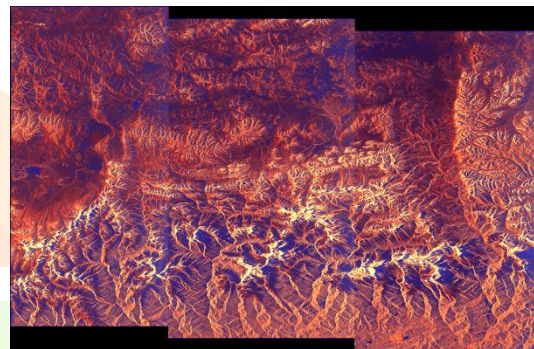

Fig 6: S1A\_IW\_SLC\_1SDV\_20150429T001842\_20150429T001909\_005691\_0074D C\_1CA1

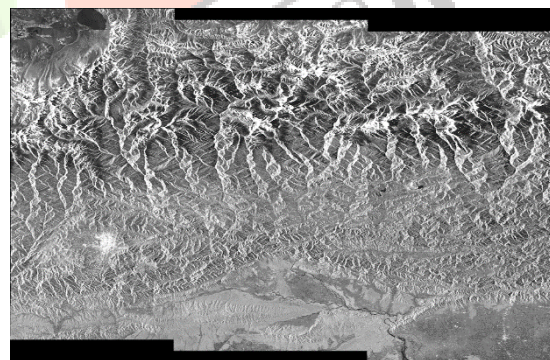

Fig 7: S1A\_IW\_SLC\_1SSV\_20150417T001852\_20150417T001922\_005516\_0070C1\_460B

(2). Input Split Images:

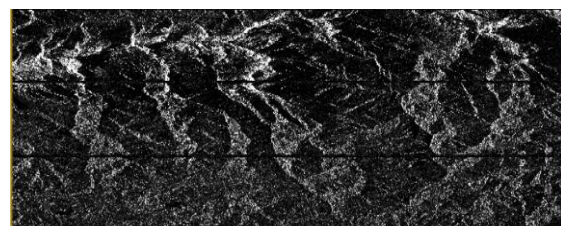

Fig 8: 17Apr\_VV\_split\_master

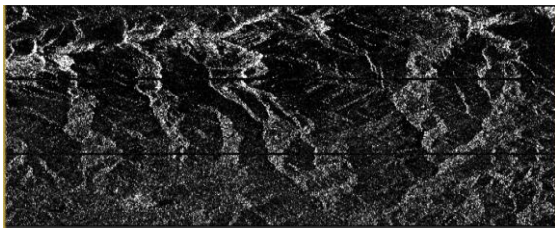

Fig 9: 29Apr\_VV\_split\_slave

(3). Interferograms Generated:

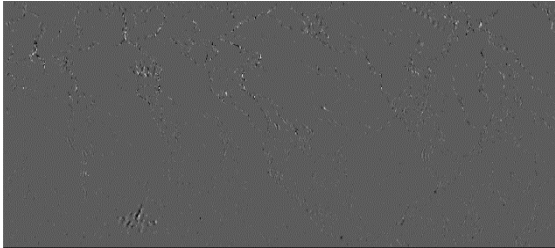

Fig 10: Interferogram\_generated\_through\_code

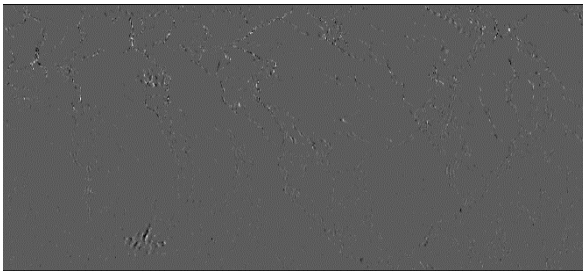

Fig 11: Interferogram\_generated\_through\_SNAP

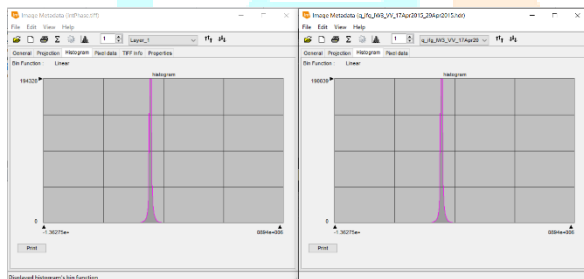

Fig 12: metadata\_histogram\_reference\_right-SNAP\_left-code

(4). Goldstein's Algorithm:

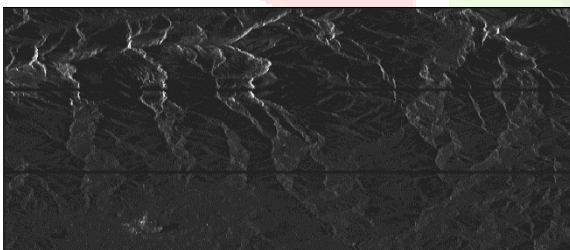

Fig 13: goldstein\_generated\_image\_from\_code

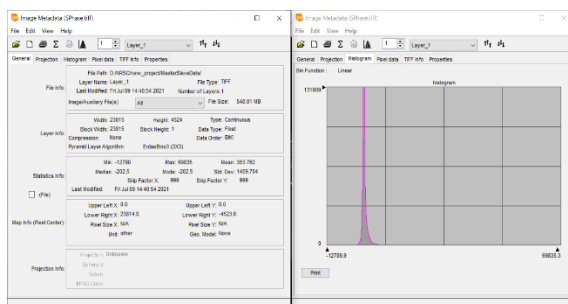

Fig 14: goldstein\_metadata\_AND\_histogram

VI. DISCUSSION AND CONCLUSION

The usage of DInSAR in infrastructure monitoring is very promising, also for the availability of free data and tools, but the expected performance should still be better assessed. It is possible to emphasize the advantages that this technique has demonstrated.

- 1) High precision in deformation assessment
- 2) Accuracy in target georeferencing.
- 3) Very high densities of monitored points.
- 4) Excellent cost-benefit ratio for wide area monitoring.

ACKNOWLEDGMENT

The authors would like to thank the NRSC for their constructive criticism and valuable comments, undoubtedly of great help in improving our paper.

REFERENCES

[1]. M. Idriss, J. M. Mathur, and H. B. Seed, "Earth dam foundation interaction during earthquakes," Earthquake Eng. Struct. Dyn. vol. 2, no. 4, pp. 313–323, 1973.

[2]. Silvia Liberata Ullo , Pia Addabbo , Diego Di Martire, Stefania Sica , Nicomino Fiscante, Luca Cicala, and Cesario Vincenzo Angelino, "Application of DInSAR Technique to High Coherence Sentinel-1 Images for Dam Monitoring and Result Validation Through In Situ Measurements".

[3].Jung, H.C.; Kim, S.W.; Jung, H.S.; Min, K.D.; Won, J.S. Satellite observation of coal mining subsidence by persistent scatterer analysis. Eng. Geol. 2007, 92, 1–13.

[4]. A. Barra et al., "A methodology to detect and update active deformation areas based on sentinel-1 SAR images," Remote Sens., vol. 9, no. 10, 2017, Art. no. 1002. [Online]. Available: <http://www.mdpi.com/2072-4292/9/10/1002>.

[5]. F. Gatelli, A. Monti Guarnieri, F. Parizzi, P. Pasquali, C. Prati, and F. Rocca, "The wavenumber shift in SAR interferometry," IEEE Trans. Geosci. Remote Sens., vol. 32, no. 4, pp. 855–865, Jul. 1994.