



INTERNATIONAL JOURNAL OF CREATIVE RESEARCH THOUGHTS (IJCRT)

An International Open Access, Peer-reviewed, Refereed Journal

Design of GaAs Based LNA at 26 GHz Band

P. Chandra Sekhar¹, Shravani Reddy Voddula², Srikanth Gavide³, Varun Masku⁴

1Assistant Professor, Department of ECE, CBIT(A), 2,3,4 4/4 ECE CBIT(A)

Abstract—Amplification is the most important functionality in modern Communication Radio receivers. The Low Noise Amplifier (LNA) is the chief design in the receiver architectures. In order to amplify the signal received from the antenna in a RF system, LNA is required. A low noise amplifier operated in 26 GHz band with maximum gain of 27.861 dB and minimum noise figure of 1.467 dB has been designed using GaAs p-HEMT technology. The design uses inductive source degeneration topology along with resistive shunt feedback amplifier to get appropriate trade-off between gain and noise figure. Advanced Design System (ADS) software has been used for observing the simulation results.

Index terms— Low noise amplifier, mm-Wave, GaAs, p-HEMT, Advanced Design System.

GHz band (24.25-27.5) GHz among those available bands to design LNA to meet the requirements.

Engineers are developing different circuits and improving the existing topologies so that devices can operate in 5G frequency spectrum. After comparing the performance of LNA in 26 GHz band among different technologies like CMOS, SiGe, InP, GaAs p-HEMT, GaAs m-HEMT, GaN and etc., GaAs p-HEMT exhibits better performance [4]-[10], [29]. Recent improvements in GaAs high electron mobile density enables GaAs p-HEMT to operate devices with good performance in high frequencies. In high-frequency circuit, it is highly efficient, compared to silicon semiconductor because of its faster operation speed and low heat generation. Since these advantages are in the high-frequency region, GaAs-based devices are mostly preferred for high frequencies [11]-[23], especially in the design of LNA.

We studied and analyzed various topologies: Common source amplifier, common gate amplifier, Inductive Source Degenerated Amplifier [25]-[26] and Resistive Shunt Feedback Amplifier [27]-[28]. Among those topologies Resistive Shunt Feedback Amplifier and Inductive Source Degenerated Amplifier topologies shows appropriate tradeoff between gain and noise figure [24]-[28].

This paper comprises of IV parts in which section II briefs about the process of designing LNA, Section III displays the results of simulation and discussions. In the end, section IV gives conclusion.

I. INTRODUCTION

The Low Noise Amplifier (LNA) is the main block and also the first level of RF receiver which is often used in wireless communication. It is often used for the amplification of weak signals received at receiver antenna. LNA consists meagre amount of internal noise, so it doesn't give much of its share to system noise [1]-[2]. As LNA is the main section of RF front end receiver, specifications like low noise figure (NF) and high gain should be taken into consideration while designing LNA to maintain overall receiver NF low. There are many applications of LNA in the field of communication such as in wireless communications, astronomy applications, radar and satellite communications, telecommunication etc. Gain, Noise Figure, input return loss and output return loss are the basic specifications of LNA. For the representation of these specifications S-Parameters of an amplifier are used. Along with these features some of other features to be considered while designing LNA are linearity, stability, bandwidth and power dissipation.

Until now, many LNAs are designed for various applications in 3G, 4G frequency spectrum but now, with the advances in wireless technology, LNAs designed in 4G frequency spectrum almost reached its limits and only very few further improvements can be made to LNA. Today, the desired data rates and expected communication quality are increasing exponentially. In the near future, LNAs designed in 4G frequency spectrum will not meet these requirements. To overcome this 5G mm-Wave spectrum is proposed. According to FCC, in 5G mm-Wave spectrum (24 GHz to 300 GHz), the frequency bands 26 GHz and 28 GHz can be made available for the service immediately [3] in India. So, we have chosen 26

II. DESIGN OF LNA

In this work LNA is designed to operate in 26 GHz band. The low noise amplifier has been designed and simulated using Advanced Design System (ADS) simulation software. ADS tool has many libraries. In this work, the active device used is from S – parameter library. The design uses S-parameter simulation controller to for obtain the device stability and other parameters. And to observe linearity harmonic balance simulation has been used.

In this work GaAs p-HEMT technology is used to achieve low noise figure. The main component of this amplifier is ATF-36077. It is an ultra-low-noise Pseudomorphic High Electron Mobility Transistor (p-HEMT). The main idea behind selecting ATF-36077 device in this work is due to its very low noise resistance as it decreases the sensitivity of noise performance due to variations in input impedance match by which the designing of Low Noise Amplifier will be much easier.

Inductors, capacitors and resistors are used in this design to provide input /output matching and biasing of the circuit.

The GaAs p-HEMT based LNA has been designed in this work using inductive source degeneration topology along with resistive shunt feedback topology to get appropriate trade-off between noise figure and gain.

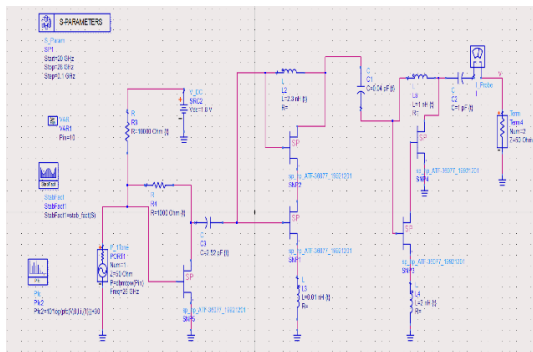

Fig. 1 Circuit design of LNA

Fig. 1 Represents the circuit design of the designed GaAs p-HEMT based LNA.

From the Fig. 1 LNA’s initial stage at input is designed using resistive shunt feedback topology to make noise figure low and the other two stages of LNA are made up of inductive source degeneration topology to improve the overall gain of the amplifier. The supply voltage applied for this circuit is 1.8 V.

III. SIMULATION RESULTS AND DISCUSSIONS

The designed low noise amplifier circuit as shown in Fig.1 has simulated and analysed with the help of ADS tool. First, we need to check the whether the circuit is unconditionally stable or not. For the circuit to be unconditionally stable $K > 1$ and $|\Delta| < 1$.

Where,

$$K = \frac{1 + |\Delta|^2 - |S_{11}|^2 - |S_{22}|^2}{2|S_{12}||S_{21}|}$$

$$\Delta = S_{11}S_{22} - S_{12}S_{21}$$

S_{11} = input return loss

S_{22} = output return loss

S_{12} = reverse gain

S_{21} = forward gain

The simulation result for stability factor of designed LNA is shown in Fig. 2. The result indicates that the LNA is stable as the stability factor is greater than 1.

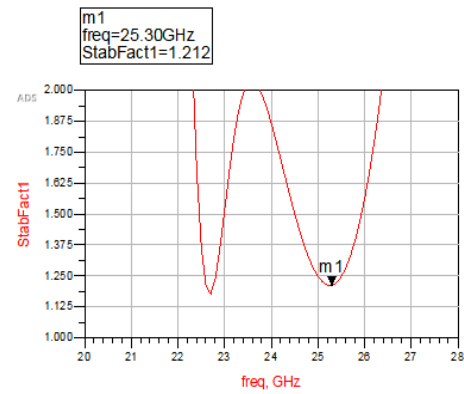

Fig. 2 Stability factor of LNA

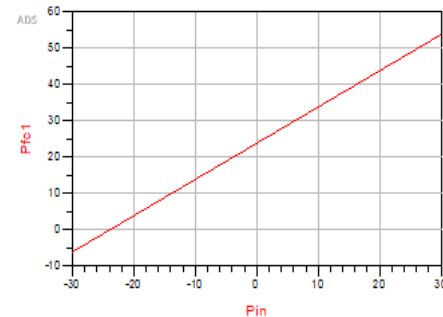

Fig. 3 Linearity of LNA

Fig. 3 Simulation output of linear characteristics of the proposed LNA. Results indicate that the system which was designed is linear in the entire region of operation.

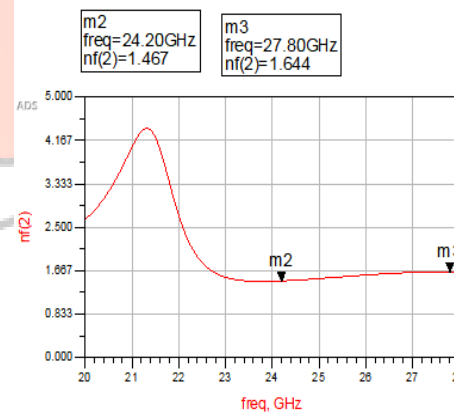

Fig. 4 Noise figure of LNA

Fig. 4 Shows simulation output of Noise figure of our Final LNA design. Results indicate that the NF is optimized at 26 GHz band (24.25 GHz-27.5 GHz) which is the new frequency band of use for future 5G communication systems in India. The NF of our proposed LNA design is around 1.5 dB (1.467 dB-1.64 dB).

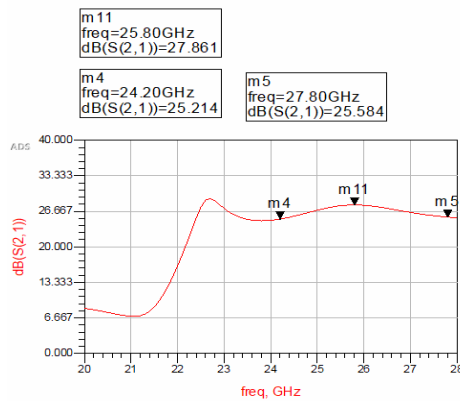

Fig. 5 Gain of LNA

Fig. 5 Shows simulation output of S_{21} for the designed LNA. The gain is optimized with the minimum of 25 dB and maximum gain of 27.861 dB in 26 GHz band.

Fig. 6 S_{11} of LNA

Fig. 6 shows simulation output of S_{11} for designed LNA circuit. Results indicate that the S_{11} is negative in 26 GHz band.

Fig. 7 S_{22} of LNA

Fig. 7 shows simulation output of S_{22} for designed LNA circuit. Results indicate that the S_{22} is negative in 26 GHz band.

IV. CONCLUSIONS

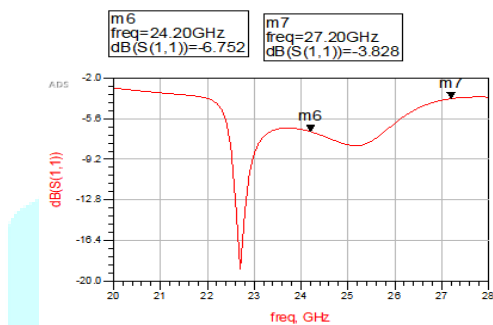
In this paper, the design of GaAs p-HEMT based LNA operated in 26 GHz band has been presented. It is observed that designed circuit is unconditionally stable. The power supply applied to the circuit is 1.8 V. The simulation results show that maximum gain of 27.861 dB in the required 26 GHz band is obtained at 25.80 GHz and the minimum noise figure of 1.467 dB is obtained.

REFERENCES

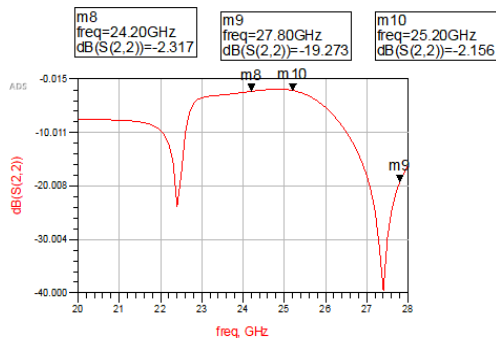
- [1] B. Heydari, M. Bohsali, E. Adabi, and A. M. Niknejad, "Low-power mm-wave components up to 104 GHz in 90 nm CMOS", IEEE ISSCC Dig. Tech. Papers, 2007, pp. 200-201.
- [2] B. Huang, C. Wang, C. Chen, M. Lei, P. Huang, K. Lin, and H. Wang, "Design and analysis for a 60 GHz low-noise amplifier with RF ESD Protection", IEEE Trans. Microw. Theory Tech., vol. 57, no. 2, pp. 298-305, Feb. 2009.
- [3] GSA, "mm-Wave bands for 5G-India", October 2020.
- [4] Bolun Cu, John R. Long, David L. Harame, "A 1.7-dB Minimum NF, 22-32 GHz Low-Noise Feedback Amplifier with Multistage Noise Matching in 22-nm SOI-CMOS", IEEE Radio Frequency Integrated Circuits Symposium (RFIC), pp. 211-214, June 2019.
- [5] Yuseok Jeon, Sungil Bang, "Front-End Module of 18-40 GHz Ultra-Wideband Receiver for Electronic Warfare System", Journal of Engineering and Science, vol. 18, pp. 188-198, July 2018.
- [6] Jiajun Zhang, Dixian Zhao, "A Broadband 1-dB Noise Figure GaAs Low-Noise Amplifier for Millimeter-Wave 5G Base-Station", International Conference of Microwave and Millimeter wave Technology (ICMMT), pp 1-3, May 2018.
- [7] Jeffrey A. Shatzman, "An Electronically Re-Configurable Three Band Low-Noise Amplifier in 0.5 μm GaAs pHEMT Technology", May 2011.
- [8] Armagan Dascurcu & Yasar Gurbuz, "A Low Noise Amplifier for 5G Applications in 0.13- μm SiGe HBT technology".
- [9] Nur Syahadah Yusof, Mohamed Fauzi Packeer Mohamed, Mohamad Faiz Mohamed Omar, Mohd Fadzil Ain, Norlaili Mohd Nor, Mohamad Adzhar Md Zawawi, Mohammad Khairi Ishak, Mohd Hendra Hairi, "28 GHz Off-the-Shelf Low Noise Amplifier for 5G Baseband Wireless System", International Journal of Innovative Technology and Exploring Engineering (IJITEE), ISSN: 2278-3075, vol: 9, Issue: 3, January 2020.
- [10] C. Huang, H. Kuo, T. Huang, and H. Chuang, "Low-power, high-gain V-band CMOS low noise amplifier for microwave radiometer applications", IEEE Microw. Wireless Compon. Lett., vol. 21, no. 2, pp. 104-106, Feb. 2011.
- [11] R. Thakkallapally, V. Veeram, I. Abdel-Motaleb and Z. Shen, "One-directional 3D-SiC MESFET for high power applications", IEEE National Aerospace and Electronics Conference, ISSN: 2379-2027, pp. 13-16, June 2014.
- [12] U. Gustavsson, T. Lejon, C. Fager, and H. Zirath, "Design of highly efficient, high output power, 1-band class D-1 RF power amplifiers using GaN MESFET devices", European Microwave Integrated Circuit Conference, pp. 291-294, October 2007.
- [13] A. Higashisaka, Y. Takayama, and F. Hasegawa, "A high-power GaAs MESFET with an experimentally optimized pattern", IEEE Transactions on Electron Devices, vol. 27, pp. 1025-1029, June 1980.
- [14] S. May, D. Maassen, F. Rautschke, and G. Boeck, "Two stage 4-8 GHz, 5 W GaN-HEMT amplifier", European Microwave Conference (EuMC), pp. 136-139, October 2017.
- [15] V. Markovic, B. Milovanovic, and N. Males-Ilic, "MESFET noise model based on three equivalent temperatures", European Microwave Conference, vol. 2, pp. 966-971, September 1997.
- [16] V. Markovic, B. Milovanovic, and N. Males-Ilic, "Efficient MESFET noise modeling including correlation coefficient", International Conference on Microelectronics, vol. 1, pp. 245-248, September 1997.
- [17] V. Markovic, B. Milovanovic, O. Pronic, and N. Males-Ilic, "MESFET noise modeling by using explicit relations for three equivalent temperatures", Mediterranean Electrotechnical Conference, vol. 1, pp. 311-315, May 1998.
- [18] N. Males-Ilic, V. Markovic, and B. Milovanovic, "New MESFET noise models as user-defined elements of program Libra library", International Conference on Micro-electronics, vol. 1, pp. 137-140, 2000.
- [19] H. Goronkin and V. Nair, "Comparison of GaAs MESFET noise figures", IEEE Electron Device Letters, vol. 6, pp. 47-49, January 1985.
- [20] E. C. Niehenke, "The evolution of low noise devices and amplifiers", IEEE International Microwave Symposium Digest, pp. 1-3, June 2012.
- [21] K. Shibata, K. Nakayama, M. Ohtsubo, H. Kawasaki, S. Hori, and K. Kamei, "20 GHz-band low-noise HEMT amplifier", IEEE International Microwave Symposium Digest, pp. 75-78, June 1986.

[22] J. M. Schellenberg, M. V. Maher, S. K. Wang, K. G. Wang, and K. K. Yu, "35 GHz low noise HEMT amplifier", IEEE International Microwave Symposium Digest, vol. 1, pp. 441–442, May 1987.

[23] K. Joshin, T. Otori, and M. Takikawa, "Super-low-noise HEMT based on new HEMT noise model", European Microwave Conference, pp. 102–104, September 1993.

[24] Lakshmi Balla, Venkata Krishna Sharma Gollakota, Sandhya Teku, "Different LNA Topologies Designed with HEMT Technologies at Ka and Q Bands", International Journal of Innovative Technology and Exploring Engineering (IJITEE), ISSN: 2278-3075, vol: 9, Issue: 2S2, December 2019.

[25] T. Lange, "Noise characterization of linear two-ports in terms of invariant parameters", ISBN: 970521835398, Cambridge University Press, 2nd ed., 2004.

[26] S. Voinigescu, "High-Frequency Integrated Circuits", ISBN: 978-0521873024, Cambridge University Press, 1st ed., 2013.

[27] B. G. Perumana, J. H. C. Zhan, S. S. Taylor, B. R. Carlton, and J. Laskar, "Resistive-feedback CMOS low-noise amplifiers for multiband applications", IEEE Transactions on Microwave Theory and Techniques, vol. 56, pp. 1218–1225, May 2008.

[28] D. P. Navaratne, "Wide-band low noise cmos amplification stage for a square kilometre array", Master's thesis, University of Calgary, Calgary, Alberta, Canada, August 2011.

[29] Murod Kurbanov & Myeong-U Sung & Shin-Gon Kim & Keun-Pil Kil & Jee-Youl Ryu & Seok-Ho Noh & Min Yoon, "Design of 24 GHz Differential Low-Noise Amplifier Using TSMC 130nm RF CMOS Technology", November 2018.

