



REVIEW OFF THERMOELECTRIC POWER GENERATION

DEEPA.S

Associate Professor, Electrical and Electronics Engineering
SCMS SCHOOL OF ENGINEERING AND TECHNOLOGY, KARUKUTTY, ERNAKULAM, INDIA

Abstract: Electrical energy has a vital role in the development of civilization as it is the most refined form of energy. Load demand of the power system varies with the electricity consumption. As the power generation has to meet the varying load demand for an efficient system, various technologies like thermoelectric power generation can be used. Thermal energy can be recovered as electricity by using thermoelectric generator module. It can be related to energy conservation and reduces the maximum demand of energy with power energy management. This paper contains the basic concepts of thermo electric power generation and its applications are reviewed and discussed here.

Key words – TEG, thermoelectric generator, Seebeck effect, thermoelectric materials

1. INTRODUCTION:

For the development of any country, electrical energy has a vital role. Some of the advantages of electrical energy are bulk power generation, economic transmission over long distance and can be efficiently distributed for domestic and commercial loads. Conventionally, electrical energy is obtained by the conversion from burning fuels or by the fusion of nuclear material or by using hydro energy Hydro energy is a replenishable source but is also limited in terms of power.

When exponentially rising population and increasing per capital energy consumption is considered, the non- replenishable fuel sources are not likely to last for a long time. Hence a co-ordinated plan is required so that energy supplied satisfies load requirement with low economical cost. In thermo electric generators, heat energy is directly converted to electrical energy. Some of the advantages of thermoelectric materials are

- 1) As there is no moving part, the working is smooth and silent.
- 2) Less maintenance is required
- 3) They are compact in size and pollution free.
- 4) It can withstand elevated temperatures for hours of steady state operations.
- 5) In rural areas where electricity is a problem, this technology is suited for small scale and remote applications.

As TEG has low conversion efficiency of 5% to 8 %, its usage is restricted to specialized fields where reliability is a major concern. Drawbacks are expensive, large output resistance and large variation in temperature .In this paper, fundamental concepts of thermo electric power are discussed and a brief overview of several applications of thermoelectric, which include thermoelectric wooden stove, power generation from waste energy etc.

2. METHODOLOGY

a. Seebeck effect

Heat is applied to two different conductor materials with a junction of difference in temperature which will generate electric current. The voltage magnitude depends on temperature difference and type of the material used. Figure (1) shows the voltage generation using Seebeck effect.

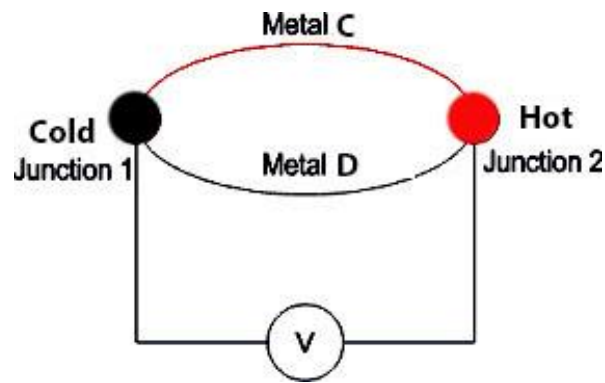

Figure (1): generation of voltage using Seebeck effect.

Here conductor C and conductor D are joined together to form junction of a circuit. They are connected in series electrically and in parallel thermally. Let the hot junction has a temperature of T_h and cold junction has a temperature of T_c . A voltmeter is placed between the two junctions to measure the voltage generated. The voltage produced is directly proportional to difference in temperature, $T_h - T_c$.

Seebeck coefficient is defined as S

$$S = \Delta V / \Delta T \quad (1)$$

Where ΔV is the thermoelectric voltage and ΔT is the temperature difference between T_h and T_c .

b. Figure of merit ZT

ZT indicates the measure of how efficiently the conversion of heat energy to electrically energy occurs in the system. It is dimensionless. ZT depends on properties of materials used and on the operating temperature T . It can be expressed as

$$ZT = T(S^2\sigma/\lambda)$$

Where S = Seebeck coefficient of material, σ = electrical conductivity and

λ = Thermal conductivity of the material

T = working temperature

When Seebeck coefficient is of high value, figure of merit is high. ZT can be increased by either increasing λ or σ . High value of ZT is preferred for the good performance of the system. ZT gives the magnitude of maximum power conversion efficiency of TE module.

c. Heat transfer

Conduction is the heat transfer mode in TE module. Heat moves from high temperature to low temperature as temperature difference is the input force to the system, heat transfer occurs. Thermal conduction is proportional to the magnitude of the temperature gradient

$$Qh = -\Delta T / Rh \quad (3)$$

Where Rh is the thermal resistance, Qh is the rate of heat transfer and ΔT is the temperature difference.

$$\text{Thermal resistance } Rh = \Delta x / \sigma A \quad (4)$$

Where Δx is the heat transfer distance, σ = coefficient of thermal conductivity and

A = Surface area

d. Maximum efficiency

TE devices are dependent on temperature gradient and absolute temperature values. TE device can generate DC whenever there is a temperature difference.

$$\text{Maximum efficiency } \eta = \frac{(T_h - T_c)}{T_c} \left(\frac{\alpha - 1}{\alpha + 1} \right) \quad (5)$$

Where $\alpha = 1 + z * T_{avg}^{1/2}$

Z^* = optimum value Z for P type / N type material in TE device

$$T_{avg} = (T_h + T_c) / 2 \quad (6)$$

3. WORKING OF THERMO ELECTRIC POWER GENERATOR

Thermo electric devices convert thermal energy into electrical energy and vice versa. A thermo couple is formed with two dissimilar metals with two junctions (hot junction and cold junction). When hot and cold junctions are interchanged, the direction of flow of current is reversed. Heat sink is provided at the cold junction to maintain temperature T_c . Charge carriers in the thermoelectric materials are electrons and holes. The motion of charge carriers leads to a temperature difference across the device.

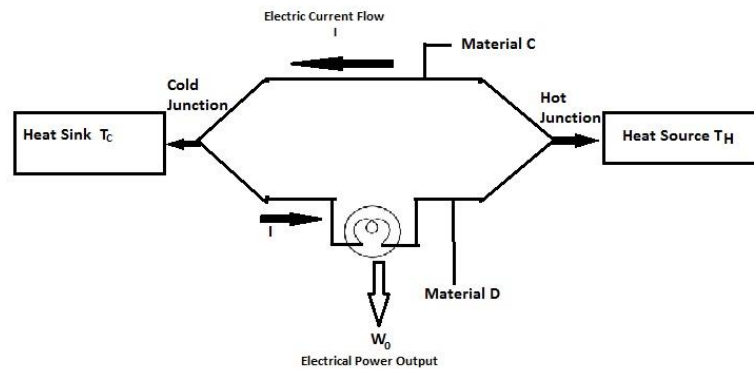

Figure (3) Schematic diagram of thermo electric generation

Positive entropy change occur during heat transfer process. When current flows Joule effect occurs and heat energy is dissipated in the resistance of TEG.

4. TEG STRUCTURE

The TEG device consist of more number of thermocouples Fig(3) Schematic diagram of thermo electric generation Simplest TEG has f P – type and n- type semiconductor material which form thermo couple .Here two legs are linked by conductor forming a connection .

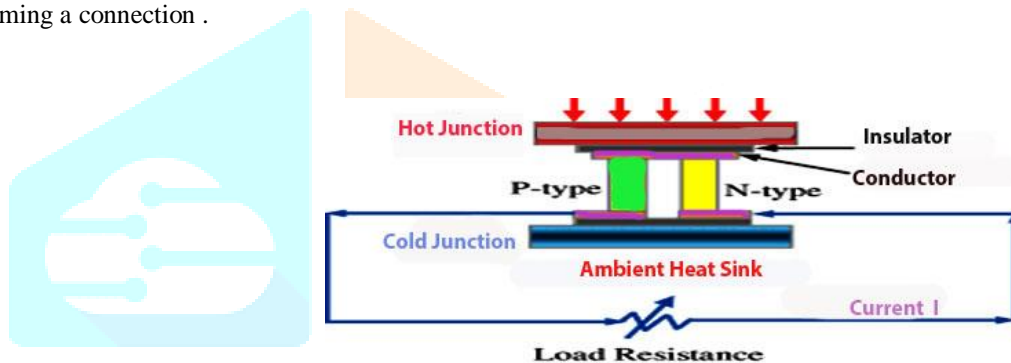

Figure (3) Schematic diagram of thermo electric power generation

P- type leg has excess number of holes and has positive Seebeck coefficient. N- type leg has excess number of electrons and has negative Seebeck coefficient. A voltage is produced across load resistance when current flows through it. Power increases when temperature difference across the module increases.

5. COMPOSITION OF THERMO ELECTRIC GENERATOR MODULE

Figure (4) shows the arrangement of a conventional single-stage thermoelectric power generator. The foundation is two ceramic plates which provide mechanical strength and insulation to p-type and n-type semiconductors. Alumina (Al_2O_3) is used as material for ceramic plate. The semiconductor materials (silicon-germanium SiGe, lead-telluride PbTe based alloys) are placed between the ceramic plates Copper strips interconnects the junction connecting thermo elements between cold and hot plates. . The size of thermoelectric device vary from 3 mm^2 to 75 mm^2 . The Length of the thermoelectric module can be up to 50 mm .The height of one stage thermoelectric modules ranges from 1 to 5 mm. The thickness of the module vary from 4 mm to 5mm. 3 to 127 thermocouples are used in a module. To meet large temperature difference, multi stage thermo electric devices can be used .Height of the such stage thermoelectric modules can be up to 20 mm.

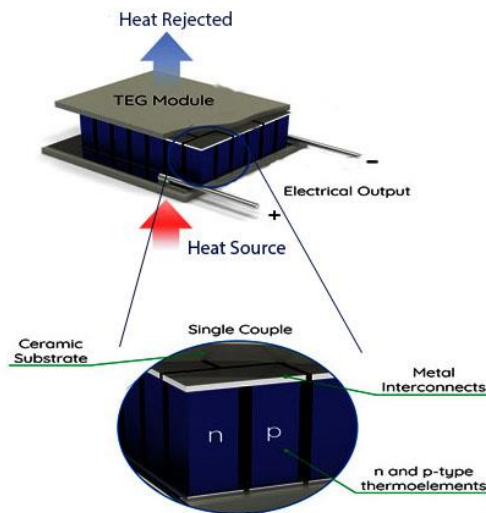

Figure4: Thermoelectric Generator module

The electrical power output of TEG ranges from microwatts to kilowatts. For a given cross-sectional area, maximum output increases with decrease in length of thermo element. Maximum output varies with contact properties and geometry of module.

6. BLOCK DIAGRAM OF THERMO ELECTRIC ENERGY SYSTEM

The main components in the thermoelectric energy system are

(1) TEG

If the temperature gradient is provided between hot and cold junction of the device, the output terminal of TEG can provide electric power to the external load.

(2) Heat source

Heat pipe system work with medium temperature to high temperature range. Water is the fluid used with a working temperature of 300⁰ C. Heat exchanger absorbs heat and transfer to TEG. TEG converts thermal energy into electrical energy partially. Remaining heat energy is transferred to cooling system and is dissipated.

(3) Cold source

They are generally heat sinks, cooling blocks and radiators. It helps to maintain a temperature difference in TEG.

(4) DC- DC converter

Converter is used to obtain different dc voltage level.. As the output of TEG varies, DC- DC converters are used to satisfy load requirements. For DC- DC converter, controllers are used to regulate voltage of DC- DC converter.

(5) Load

Load is connected to electric storage which can be either super capacitor or battery storage system. To avoid overcharging of battery, a regulator is required.

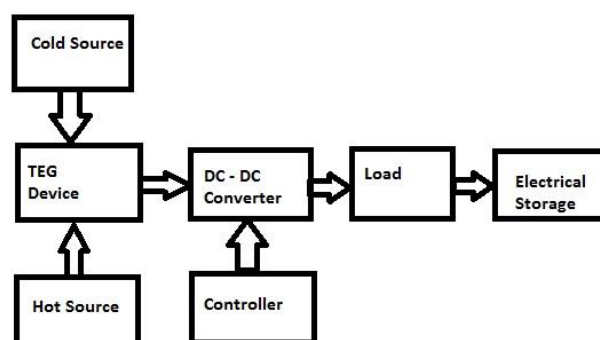

Figure5: Block Diagram of thermo electric energy system

7. PERFORMANCE OF THERMOELECTRIC POWER GENERATORS

The performance of TEG depends on figure of merit ZT . Figure of merit varies with different thermoelectric materials. Figure (6) shows variation of efficiency with electric power output for various figure of merit of thermo electric materials. When ΔT is increasing, efficiency also increases. For a figure of merit of 3, conversion efficiency is found to be 23% for a temperature difference of 600K.

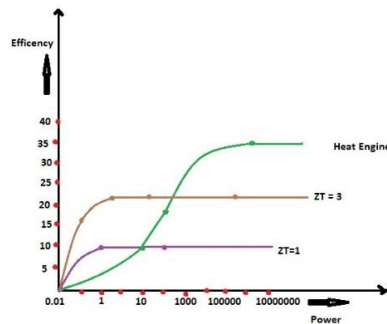

Figure 6: Graph showing conversion efficiency for different figure of merit

8. APPLICATIONS

The performance of TEG can be improved by using components that require less maintenance. Thermo electric generation can be used for medium power requirements in remote places, mountains or in deep oceans.

- TEG are used on gas pipe lines where radio communication, telemetry and cathodic protection is required. Power consumption in gas pipelines are up to 5 KW that can be easily provided by using thermo electric generators.
- Thermoelectric Generators are used as remote and off-grid power generators for remote areas.
- The Solar PV panel with TEG can be used in power system for meeting load requirements. When solar PV panel is down then TEG will act as a backup source till solar PV can take the load.
- TEG increases the fuel efficiency of entire automobile system by using waste heat energy. Waste heat from microprocessors, Solar PV system, heating from communication towers, b.

9. EXPERIMENTAL SETUP OF THERMOELECTRIC GENERATION

a) BY USING THERMOELECTRIC WOODEN STOVE

By using thermoelectric module, heat energy from the burning stove is converted into electrical energy. Figure 7 shows the block diagram of thermo electric stove. TEC 12704 is the specification of TEG module used. Heat sink is provided to keep heat equally to all the cells cooling system is used so that cold junction is maintained at desired temperature. The output voltage of each cell is 2.25 Volt and 20 Volt is obtained by connecting all cells in series. 12V, 7 Ah battery is used to store the electrical energy generated from TEG module. An inverter is used to convert dc energy stored in the battery to AC so that house hold appliances can be connected to it. IC 3525 is used as the oscillator which provides necessary frequency of output square wave. IRF44 MOSFET is used to amplify the electronic signals. The center tapped transformer with input of 12V and output of 230V is used to step up the voltage to 230V

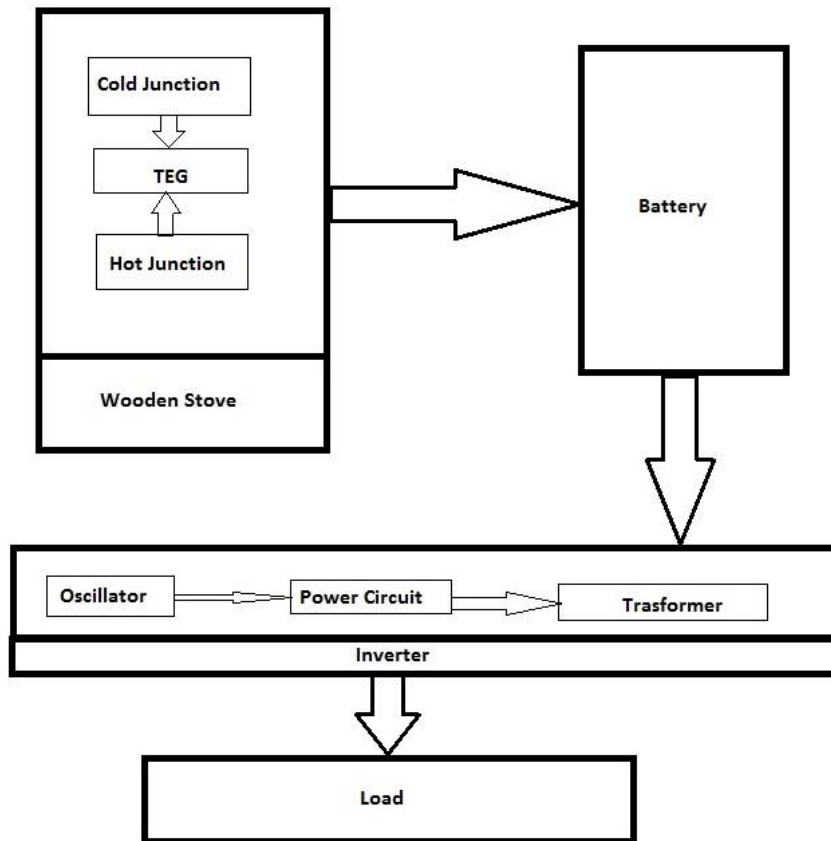

Fig 7Block Diagram of Thermoelectric Stove

When a temperature difference is build up at TEG module through wooden stove, voltage is generated. When temperature difference is increased, voltage increases. The maximum voltage obtained is about 25V for a temperature difference of 80 degree Celsius. Figure 8 shows the curve between voltage generated across TEG and temperature difference. A diode is kept between the battery and stove in order to avoid reverse flow of energy from the battery to the modules. The output of inverter is connected to bulb and fan

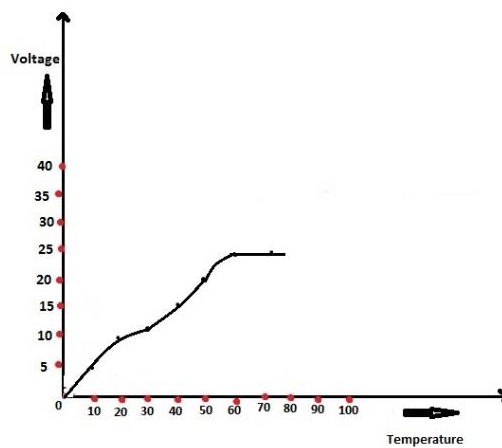

Fig: 8 Voltage versus Temperature.

b) USING WASTE HEAT ENERGY FROM AUTOMOBILES

Heat energy from the automobile is utilized for electric power generation.

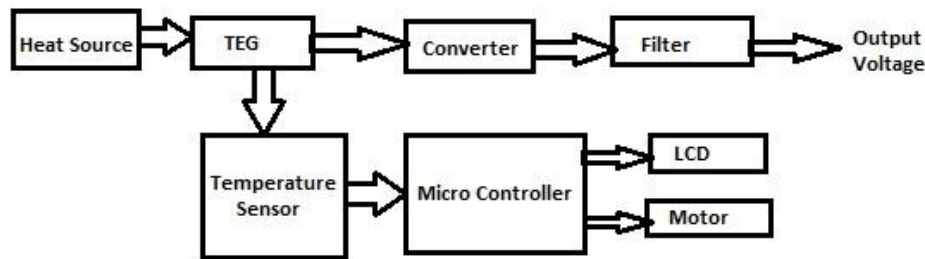

Figure shows the block diagram of proposed system

TEG SPI 1848-27145 SA is used as the TEG module. 555 Timer is used as the converter which step up the voltage of TEG module. To get pure DC voltage, Capacitor filter is used. LM 35 senses temperature of the module. The microcontroller ATMEGA 328 interfaces LM 35 with LCD display the analog output of LM 35 sensor is converted into digital signal in micro controller. When the temperature of TEG module exceeds desired value, the microcontroller turns on the motor. This helps module to cool down and temperature is maintained with in the safe limit.

12 V DC from TEG module is converted to 120V AC with the help of a transformer. 120V AC voltage is stepped down to 24 V AC and is rectified to 24 VDC using the bridge rectifier. Figure shows the simulation result of converter. For input voltage of 12V DC, 24V DC is obtained.

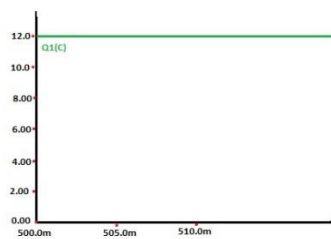

Fig: Input Voltage

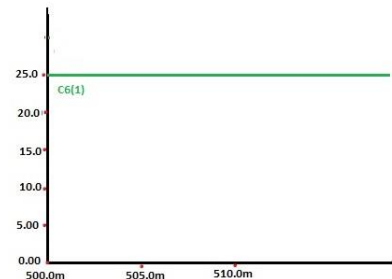

Fig: Output Voltage

10. LIMITATIONS TO THERMO ELECTRIC GENERATION

- Conversion efficiency is low.
- Cost is high
- Output resistance of generator is high
- Thermal conductivity is low
- There is difficulty in removing heat from cold side.

11. CONCLUSION

Considering the global warming issues and limited amount of energy sources, several research is going on the generation of thermo electric power in efficient manner. In this paper, basic concepts of thermoelectric power generation are discussed. Future scope in thermo electric generation is to find its application in domestic, automobile, microcontrollers, and wireless EEG system, watches and hearing aids and industrial waste heat. The electric power generated from TEG is pollution free and the developments in module configuration will help to use TEG more effectively in applications where waste heat energy can recycled and used.

REFERENCES

- [1] Donald T Morelli, Potential applications of advanced Thermo electrics in the Automobile industry, 15th International conference on Thermoelectric, 1996.
- [2] Basel I Ismail, Wael H Ahmed, Thermo electric Power Generation Using Waste heat energy as an Alternative Green Technology, Recent patents in Electrical Engineering, 2009.
- [3] Diana Enescu, Thermoelectric energy harvesting, e book, Green energy Advance.
- [4] Waste Energy Harvesting: Mechanical and Thermal energies by Kong ling Ben, Tao Lie Huey Freddy Bocy, Sean Lie Tian Shu Zhang.
- [5] Engineering Scoping Study of Thermoelectric Generator Systems for Industrial Waste Heat Recovery November 2006 Dr. Terry Hendricks Pacific Northwest National Laboratory William T. Choate BCS, Incorporated.
- [6] Elsheikh, M.H.; Shnawah, D.A.; Sabri, M.F.M.; Said, S.M.; Hassan, M.H.; Bashir, M.B.A.; Mohamad, M. A review on thermoelectric renewable energy: Principle parameters that affect their performance. *Renew. Sustain. Energy Rev.* 2014, 30, 337–355. [CrossRef].
- [7] Stoll, B.L.; A SmithiD, T.; Deinert, M. Potential for rooftop photovoltaics in Tokyo to replace nuclear capacity. *Environ. Res. Lett.* 2013, 8, 014042. [CrossRef].
- [8] Arutyunov, V.S.; Lisichkin, G.V. Energy resources of the 21st century: Problems and forecasts. Can renewable energy sources replace fossil fuels? *Russ. Chem. Rev.* 2017, 86, 777–804. [CrossRef].
- [9] Oral, A.Y.; Oral, Z.B.B. (Eds.) 3rd International Congress on Energy Efficiency and Energy Related Materials (ENEFM2015): Proceedings, Oludeniz, Turkey, 19–23 October 2015.
- [10] Springer International Publishing: Berlin/Heidelberg, Germany, 2017; Available online: <https://www.springer.com/us/book/9783319456768> (accessed on 8 June 2018).
- [11] Mohamed Amine Zoui, Said Bentouba, John stochohm and Mahmoud Bourois, Review on thermoelectric generator, energies 2020.

