

# Seismic Response and Evaluation of Cantilever Retaining Wall

Mr. Nasim khan, Mr. Aftab Alam

M.Tech Structural Engg., Department of Civil Engineering, MRIU Faridabad, India

Assistant Professor, Department of Civil Engineering, MRIU Faridabad, India

## ABSTRACT:

A Cantilever retaining wall is one of the most important types of retaining structures. It is extensively used in variety of situations such as highway engineering, railway engineering, bridge engineering and irrigation engineering. Reinforced concrete retaining walls have a vertical or inclined stem cast with base slab. For greater heights earth pressure due to retained fill will be higher due to lever arm effect, higher moments are produced at base, which leads to higher section for stability design as well as structural design. This studies the stability and performance for seismic response and evaluation of cantilever retaining wall with the help of a finite element method, STAAD.pro. While the following provisions of the Indian Standard Code, IS 456:2000 and IS 1893: 1984/2002 for the sections.

**Keywords:** Retaining wall, Mono-nobe-okabe method, Seismic, Staad.pro

## 1. INTRODUCTION:

A cantilever retaining wall is one of the most important types of soil retaining structures. The primary purpose of retaining wall is to retain earth or other material at or near vertical position. It is extensively used in variety of situations such as highway engineering, railway engineering, bridge engineering, dock and harbor engineering, irrigation engineering, land reclamation and coastal engineering etc. Reinforced concrete retaining walls have a vertical or inclined stem cast monolithic with a base slab. These are considered suitable up to a height of 5 to 7m. It resists the lateral earth pressure by cantilever action of the stem, toe slab and heel slab.

A continuous investigation and study is going on the various types of retaining walls for achieving optimum economy, developing speedy and easy construction processes, reducing section of wall components and ultimately to get the wall of maximum strength and durability. This is possible only by reducing the earth pressure behind the wall. Various techniques have been developed for reducing the earth pressure behind wall.

The cantilever retaining wall bends as well as translates and rotates. They rely on the flexural strength to resist lateral earth pressures. The actual distribution of lateral earth pressure on a cantilever wall is influenced by the relative stiffness and deformation both the wall and the soil.

## 2. METHODOLOGY:

To perform the study of the topic of Seismic Response Evaluation of cantilever retaining wall. It considered two models 6m of cantilever retaining wall with identical property and geometry having M20 grade of concrete and load is applied for static and dynamic. It considered two models of cantilever retaining wall with different zone one cantilever retaining wall is located in seismic zone IV and another retaining wall is located in seismic zone V and analyzed their base pressure, displacement, reinforcement, cost of steel, earth pressure and stress etc. Using STAAD.pro Static and Dynamic analysis has been performed considering dead load, live load and seismic load.

The dynamic and active earth pressure coefficients for the cohesion-less backfill computed from the Mono-Nobe-Okabe method and Rankine's theory analysis are in reasonably good with values developed in (model) structures. A cross section of cantilever retaining wall is analyzed by using limit state method for I.S. code (1893- 1984/2002 and 456 - 2000) and calculated the stresses, reinforcement, base pressure etc.

A 2D finite element modeling of the cantilever retaining wall analyzed and design in STAAD-pro and the Results obtained are compared with those obtained in between manual and fem for cantilever retaining wall zone IV and zone V.

### 3. STRUCTURE MODELING:

A design example is given here to understand the procedure used in the analysis of retaining wall in this study. Analysis and design has been carried out by considering the stated properties of cohesion less backfill and also height of backfill to be retained for cantilever retaining wall. The t dimensions for cantilever retaining wall are adopted based on prevailing thumb-rules. The detail calculations for cantilever retaining wall are given and the calculated results have been presented. At the end the calculated results for different cases are presented in the tabular form.

For analysis, we have considered two models of cantilever retaining wall with varying zone locations in which both have identical geometry and property.

Table 1.Geometric and geotechnical characteristics of reinforced retaining wall

Type of wall	Cantilever retaining wall
Width of the wall	1m
Model 1 retaining wall is located in seismic	zone V (Z = 0.36)
Model 2 retaining wall is located in seismic	zone IV (Z = 0.24)
Soil bearing capacity	200 $\text{KN}/\text{m}^3$
Height of retaining wall	6m
Base Width of wall	4.5m
Stem thickness at top	0.25m
<b>2</b>	
Base thickness of wall	0.5m
Soil type	Hard-soil
Clear cover	40mm
Angle of internal soil friction	$\phi = 30^\circ$
Concrete grade	M20
Steel grade	Fe415
Angle of Wall friction	$(\delta) = 20^\circ$
Angle of back face of wall with vertical	$(\alpha) = 0^\circ$
Reinforced concrete	25 $\text{KN}/\text{m}^3$
Unit weight of backfill soil	18 $\text{KN}/\text{m}^3$

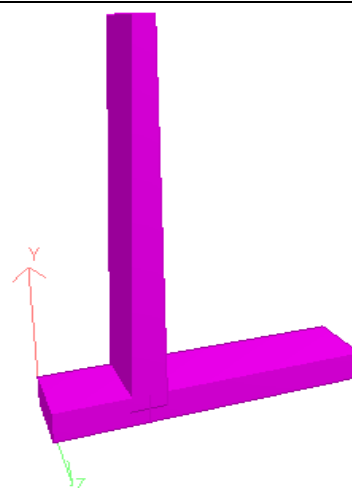
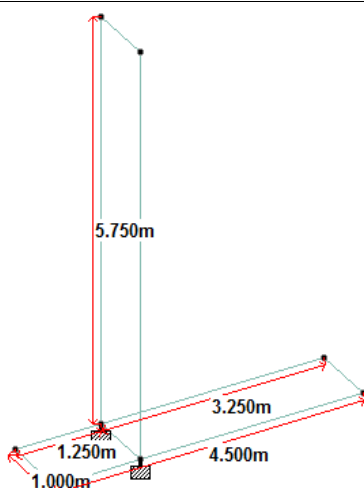

Fig.1 Node to node distance

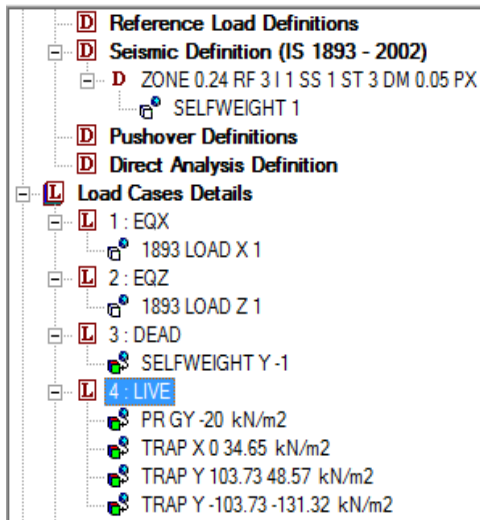

Fig.2 3D structure rendered view

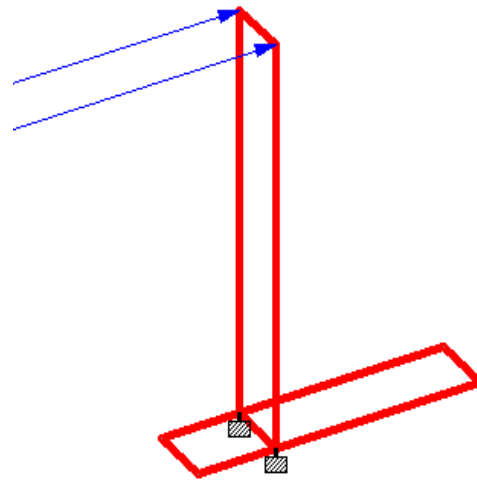

Fig. 3 Seismic Load and definition

Seismic in X- direction

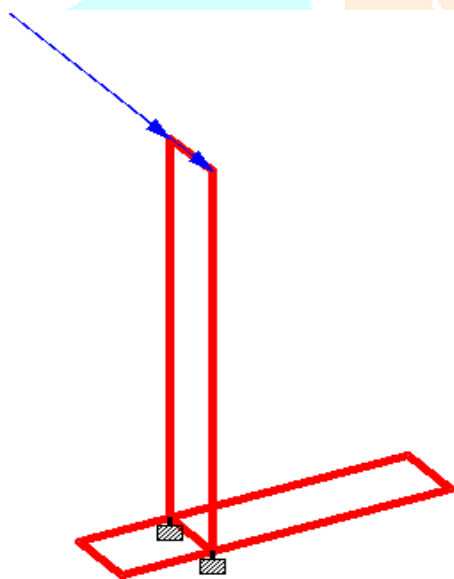

Fig.4

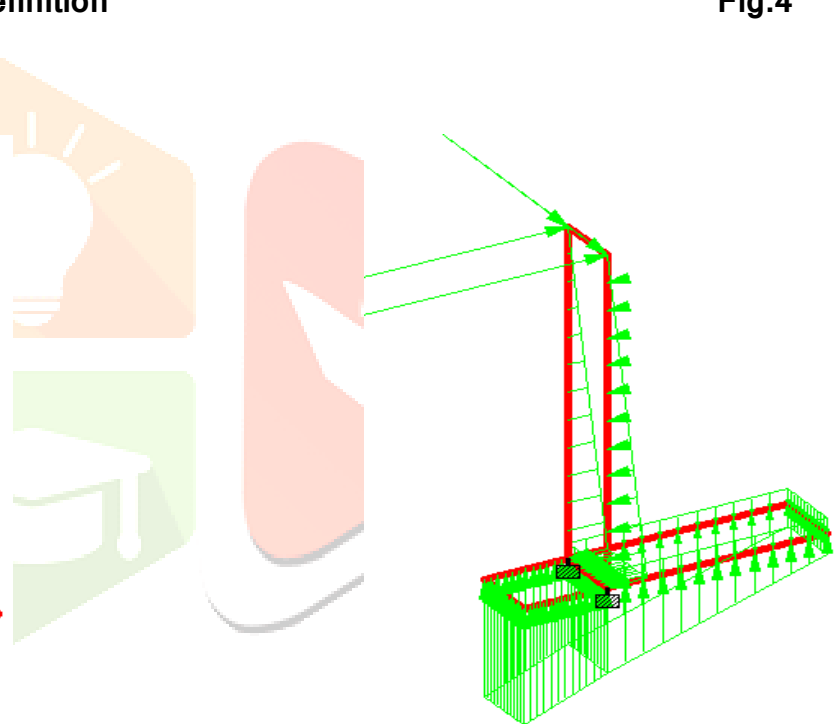

Fig.5 Seismic in Z- direction

Fig.6 Load acted on different orientation

4. RESULT AND DISCUSSION:

4.1 Seismic Coefficient for Zone IV and Zone V:

This table is an estimate of Horizontal, vertical, active, dynamic and passive coefficient has been tabulated which is as following:

Table 2 Seismic Coefficients

Seismic coefficient	Zone V	Zone IV
Horizontal seismic coefficient	0.15	0.10
Vertical seismic coefficient	0.1	0.06

Active pressure coefficient	0.33	0.33
Dynamic pressure coefficient	0.43	0.35
Passive earth pressure coefficient	3	3

#### 4.2 Static and Dynamic Lateral Earth Pressure for Zone IV and Zone V:

This parameter is an estimate of the maximum expected lateral force that will occur due to seismic ground motion at the base of a structure.

The forces acting at different heights of two models have been tabulated which is as following:

Table.3 Static and Dynamic Lateral Earth Pressure Difference

Cantilever retaining wall in zone V	$KN/m^2$	Cantilever retaining wall in zone IV	$KN/m^2$
Active earth pressure at height (H/2)	32.67	Active earth pressure (H/2)	32.67
Dynamic pressure at height (H/3)	42.57	Dynamic pressure (H/3)	34.65
Dynamic pressure increment	9.9	Dynamic pressure increment	1.98
Maximum base pressure	152.01	Maximum base pressure	131.32
Minimum base pressure	27.88	Minimum base pressure	48.57

#### 4.3 Maximum Deflection:

Maximum nodes deflection of two structures has been analyzed by transferring the structure to post processing in STAAD-pro and the respective deflection have been represented in tabular form which is as following:

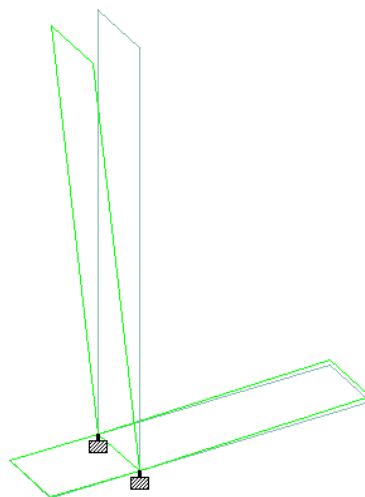

Fig. 7 Nodal displacement

### 4.3.1 Graphical Representation

A line graph has been plotted to represent the maximum nodal displacement in all two cases with displacement in mm verses number of nodes of the structure.

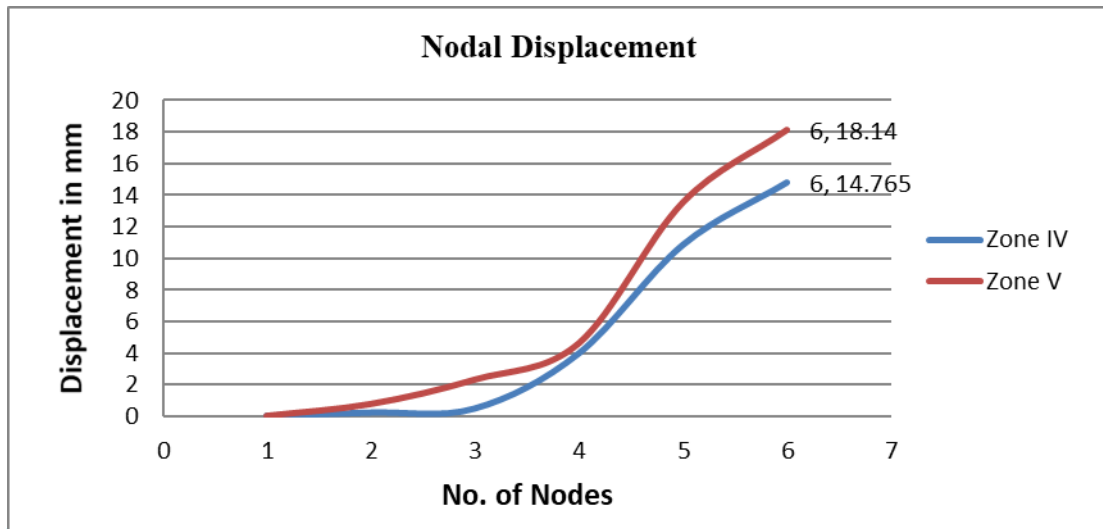

Fig. 8 Deflection of models

### 4.4 Cantilever Retaining Wall Stress:

The following figures shows the plate stress contour for load combination dead load , live load and seismic load of zone V and zone IV for maximum absolute stress which can be seen by transferring the project to post processing . The value of maximum absolute stress in plates varies from 1.18534  $N/mm^2$  to 3.4316  $N/mm^2$  in zone V. The value of maximum absolute stress in plates varies from 0.844222  $N/mm^2$  to 2.75351  $N/mm^2$  in zone IV

Minimum Stress difference for zone V and IV =  $1.18534 - 0.844222 = 0.34 N/mm^2$

Maximum Stress difference for zone V and IV =  $3.4316 - 2.75351 = 0.67 N/mm^2$

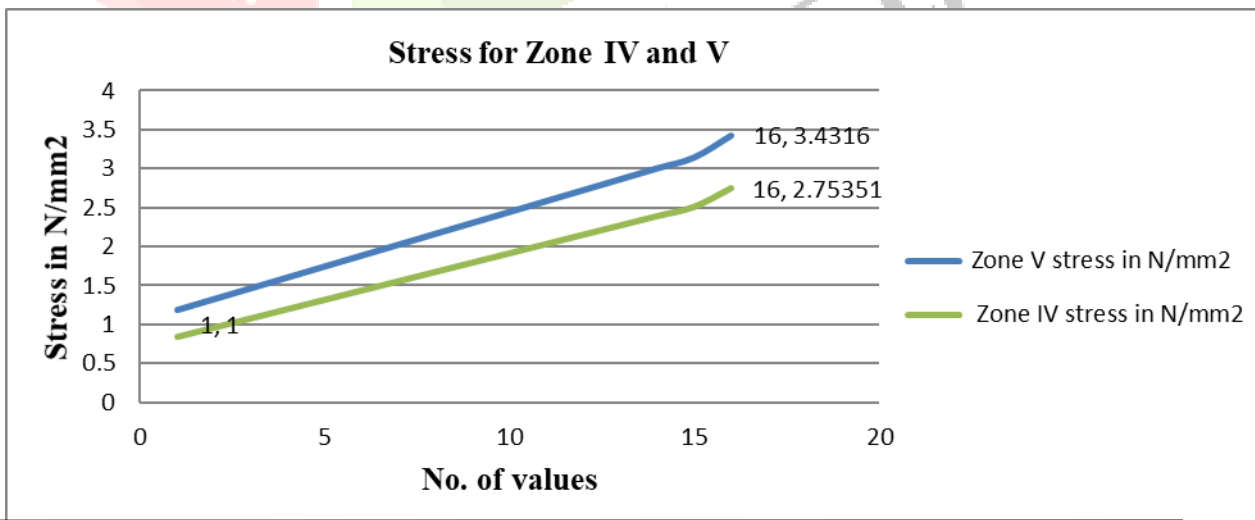

Fig. 9 Stress graph for zone iv and v

### 4.5 Reinforcement Detail for Cantilever Retaining Wall:

% Difference of steel for zone IV and V of manually =  $\frac{7805-7196}{7805} * 100 = 7.80\%$

$$\% \text{ Difference of steel for zone IV and V of Staad.pro} = \frac{6434 - 5990}{6434} * 100 = 6.90\%$$

Steel in zone V for manually = 59.86 Kg/m

Steel in zone V for Staad.pro = 50.59 Kg/m

Steel in zone IV for manually = 54.92 Kg/m

Steel in zone IV for Staad.pro = 45.65 Kg/m

Cost of steel for zone V manually = 2394.4 Rs/m

Cost of steel for zone V Staad.pro = 2023.6 Rs/m

Cost of steel for zone IV manually = 2196.8 Rs/m

Cost of steel for zone IV Staad.pro = 1826 Rs/m

**4.5.1 Graphical representation:**

This graph is represented reinforcement of two models of cantilever retaining wall have been plotted below:

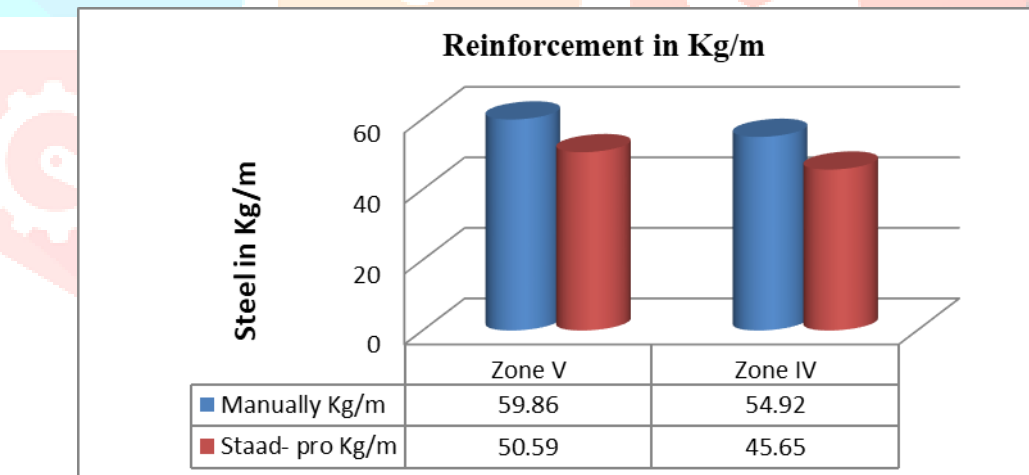

**Fig. 10 Reinforcement graph for zone v and iv**

**4.5.2 Graphical representation:**

This graph is represented cost of reinforcement of two models of cantilever retaining wall have been plotted below:

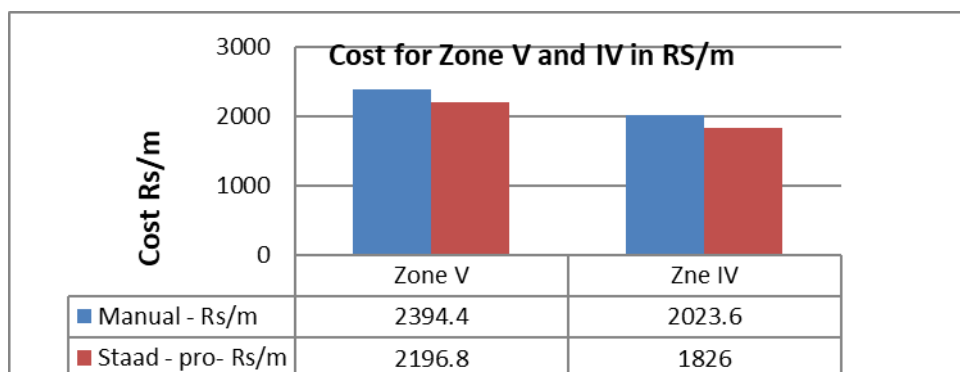

### Fig. 11 Cost comparison for zone v and iv

#### 5. CONCLUSION:

The Conclusion for the work that we have carried out in this project are as following:

1. The structures having symmetric cantilever retaining walls are subjected to less displacement. In zone IV as compared to zone V. The maximum displacement in zone IV is 14.675mm and displacement in zone V is 18.14mm.
2. Stress on cantilever retaining wall zone IV is less as compared to zone V. Line graph have been plotted to comparison of cantilever retaining wall.
3. The vertical stresses at wall base increased on the toe side and consequently reduced towards the heel side due to tilting of wall base caused by lateral seismic loads on wall stem.
4. The residual wall top displacement was large for seismic loads in X- direction.
5. The variation of this stress followed the residual wall top displacement profile. For very high seismic loads, the wall top displacement and the stresses developed in the wall stem-base joint were seismic loads.
6. Difference in value of dynamic coefficient (by Mono- Nobe – Okabe method) at zone IV is 0.35 and zone V is 0.43. The value of dynamic coefficient is based on seismic zone.
7. The structure having symmetrical cantilever retaining walls are subjected to less Reinforcement in zone IV as compared to zone V manually and STAAD.pro.
8. The structure having symmetrical cantilever retaining walls are subjected to Cost of cantilever retaining wall of zone IV is less as compared to Zone V manually and STAAD.pro.
9. Plate stress contour is shown in figure 25 and 26. This contour diagram is showing that the Top (stem) plate element are most stressed and the bottom (toe and heel) elements are least stressed.

#### 6. REFERENCES:

- [1] **Anurag upadhyay et al (2011)**. “Behavior of cantilever retaining walls under seismic Conditions”. 5th international conference on earthquake geotechnical engineering January 2011, 10-13 Santiago, chile.
- [2] **A. C. Chougule (2017)**. “Effective Use of Shelves in Cantilever Retaining Walls” International Research Journal of Engineering and Technology (IRJET) e-ISSN: 2395 -0056 Volume: 04 Issue: 07 | July - 2017.
- [3] **B.S. Tasildar et al (2015)**. “Stability of retaining wall under seismic load: a review”. International journal of engineering sciences & research technology issn: 2277-9655 (i2or), publication impact factor: 3.785 (isra), impact factor: 2.114 4(5): may, 2015.
- [4] **Dr. Ram Chandra** “Reinforced concrete structure” (Limit State Design) Chapter 16 Page No. 918.
- [5] **Dr. S.S. Patil et al (2015)**. “Analysis and design of stepped cantilever retaining wall”. International journal of engineering research & technology (ijert) issn: 2278-0181 www.ijert.org ijertv4is020033 (this work is licensed under a creative commons attribution 4.0 international license.) Vol. 4 issue 02, february- 2015.
- [6] **I.S. 456-2000**. Criteria for design of cantilever retaining wall, the given detail of how cantilever retaining wall design.
- [7] **I.S. 1893-1984/2002/2005**. Criteria of Earthquake resistance structures Part (1,4) given the estimation of horizontal and vertical coefficient or earthquake loads.
- [8] **Leuzzi Francesco et al (2010)**. “Dynamic response of cantilever retaining walls considering soil non-linearity”. Fifth international conference on recent advances in geotechnical earthquake engineering and soil dynamics.



- [9] **Mahmoud yazdani et al (2013)**. “Extended“Mononobe-okabe” method for seismic design of retaining walls”. Hindawi publishing corporation journal of applied mathematics volume 2013, article id 136132, 10 pages <http://dx.doi.org/10.1155/2013/13613>.
- [10] **N. Krishna Raju** “Design of reinforced concrete structures” 3<sup>rd</sup> Edition Chapter 10 Page No. 191-206 about Retaining walls.
- [11] **N. Sitar, N. Wagner (2015)**. “On seismic response of stiff and flexible retaining structures” 6th international conference on earthquake geotechnical engineering 1-4 november 2015 christ- church, new Zealand.
- [12] **N. Wagner(2015)**. “On Seismic Response of Stiff and Flexible Retaining Structures”. 6th International Conference on Earthquake Geotechnical Engineering 1-4 November 2015 Christchurch, New Zealand.
- [13] **Prof. Dr. D.N.Shinde (2015)**. “Optimum Static Analysis of Retaining Wall with & without shelf /Shelve at different level using finite Element analysis”. International Journal of Engineering Research and General Science Volume 3, Issue 2, Part 2, March-April, 2015 ISSN 2091-2730.
- [14] **P. Dayaratnam** “Limit State Design of Reinforced concrete Structures” Chapter 16 Page No. 511.
- [15] **Shamsher prakash et al (2012)**. “ Displacement based seismic design of retaining walls”. II international conference on performance based design in earthquake geotechnical engineering may 2012, 28-30 - taormina, Italy.
- [16] **Su Yang et al (2013)**. “Review of Studies on Retaining Wall’s Behavior on Dynamic / Seismic Condition”. Su Yang et al Int. Journal of Engineering Research and Applications [www.ijera.com](http://www.ijera.com) ISSN : 2248-9622, Vol. 3, Issue 6, Nov-Dec 2013, pp.1012-1021.
- [17] **S.N. Moghaddas tafreshi et al (2008)**. “ Seismic stability of reinforced retaining wall”. The 14<sup>th</sup> world conference on earthquake engineering october 12-17, 2008, beijing, china.
- [18] **Shoeb Mohammed Sayeed et al (2014)**. “Seismic Analysis And Design of Cantilever Retaining Walls”. International Journal of Science Engineering and Advance Technology, IJSEAT, Vol 2, ISSN 2321-6905 Issue 10 October-2014.
- [19] **Tamadher abood et al (2015)**. “Design of cantilever retaining wall with 4m height”. International journal of civil and structural engineering research issn 2348-7607 (online) vol. 3, issue 1, pp: (318-326), month: april 2015 - september 2015, available at: [www.researchpublish.com](http://www.researchpublish.com).
- [20] **Yash chaliawala et al(2015)**. “Comparative Study of Cantilever and Counter fort Retaining wall”. International Journal of Advance Engineering and Research Development Volume 2, Issue 12, December - 2015.