

IOT BASED REAL TIME EARLY WARNING BUS INFORMATION SYSTEM TO STUDENTS BY EMAIL

¹ P.Swarnalatha, ² A.Rama Vasantha,

¹ Assistant Professor, ² Assistant Professor

¹ Department of Electronics & Communication Engineering,
¹ Aditya College of Engineering & Technology, Surampalem

Abstract: This paper describes about the implementation of early warning bus information system to the students in real time based on IOT using email. It is aimed to provide college bus information regarding next arrival stop and live running status of bus to the students who are related to the respective bus. This system is implemented by using Raspberry pi that access GPS co-ordinate by GPS module interfaced to it. The complete system algorithm implemented by using Python, and entire control system built using ARM1176JZFS microcontroller. This system used in wide application areas where information regarding live running status of bus needed by passengers in real time.

IndexTerms - Raspberry pi, GPS, Python.

I. INTRODUCTION

Now, this is the age of speed, everything is happened in the speed of supersonic, and the data can be transferred at the speed of light in digital medium. Hence there is need of information inflow the same speed. This paper aimed to provide college bus information to students fast enough students always experienced in waiting at the bus stops for arrival of bus and also encounter. So many times there will be missing the bus due to lack of information regarding arrival to their respective stops. This problem which reduces the human intervention for getting college bus information.

This paper describes about implementation and deployment of system which provide college bus information to the students. The system which is placed in bus consists of GPS for continuously tracking the location of bus. Once the bus arrived at a bus stop the information about next bus stop sends email alert to students who are registered for their respective stops. This system uses controller interface with Raspberry pi which is low cost and consumes smaller amount of power, when bus arrives at the stop, Raspberry pi access GPS co-ordinate by GPS module interfaced to it, Raspberry pi compares accessed and already saved GPS coordinates and follows SMTP protocols to send email alerts. The complete system algorithm implemented by using Python, and entire control system built using ARM1176JZFS microcontroller. The system tested and implemented at college level instruction. This system used in wide application areas where information about bus needed by passengers.

II. EXISTING METHOD:

In today's world, time is money. Because of the unpredictable traffic conditions these days, the people using chartered bus services waste precious time waiting for the bus at their respective stops. So there is a need for an early warning system, for the approaching transportation vehicle. This early warning system would provide automatic alerts to passengers corresponding to their respective bus stops. These alerts would be in the form of SMS to the passengers on their registered mobile numbers. So the passengers can reach their stop just in time and board the bus without any waiting.

The alert system would be fully automatic without any need for interaction with the bus driver or passengers. The passengers would only need to register on a central website their mobile number, the bus for which they would like to get the alert, their stop and the time when they would like to get the alert.

Due to rapid increase in population, there is need for efficient public transportation system. There is increased burden on public transportation like bus just because of population. Therefore remote user needs a smart system which provides real time information of bus. So we proposed a new system which solves the drawback of current public transportation system. So our systems handle all the data like current location of bus, management of buses and its schedule. The real time tracking of bus can be done by our proposed system and this information is then given to remote user who wants to know the real time bus information. Some technologies like GPS (Global Positioning System), Google maps and GPRS (General Packet Radio Service) are used for development purpose. Our system provides web based application, which gives real time location of bus on Google maps to remote user.

The drawbacks of existing work are as follows: It is not comfortable for users who need proper time management system, no speed of data transmission and the above existing method is not applicable for real time purpose.

III. PROPOSED WORK:

The proposed system provides the relevant information regarding all the bus numbers going from user's source & destination along with the route details, real time location. Generally the early warning system illustrated in the figure.1 is operated by GPS which is attached with the bus. Firstly GPS receives the satellite signals and then the position co-ordinates with latitude and

longitude are determined by it. The location is determined with the help of GPS and transmission mechanism. After receiving the data the tracking data can be transmitted using any wireless communication.

In this paper RASPBERRY PI is a microcontroller which is a small computer. Based on IOT the students/staffs can access this information of a bus based on user’s source and destination through the android application. Our proposed system gives the real time location of bus.

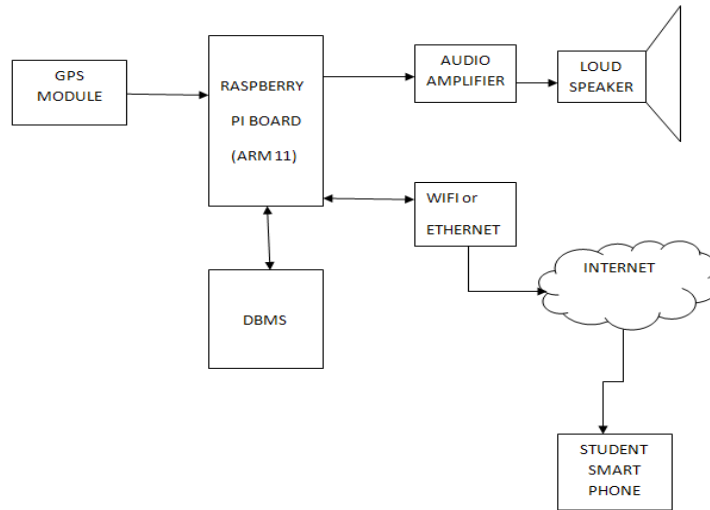

Figure1. Block Diagram of Proposed Method

IV. HARDWARE IMPLEMENTATION

The hardware implementation of this paper involves the design and the working of the early warning bus information system by interfacing Raspberry Pi board with GPS Module & DBMS which provides live bus status information & based on IOT the status updates of bus information can be sent to student smart phone as email alert.

4.1 Raspberry PI

Raspberry Pi board shown in figure.2 is a miniature marvel, packing considerable computing power into a footprint no larger than a credit card. The processor at the heart of the Raspberry Pi system is a Broadcom BCM2835 system-on-chip (SoC) multimedia processor. This means that the vast majority of the system’s components, including its central and graphics processing units along with the audio and communications hardware, are built onto that single component hidden beneath the 512 MB memory chip at the centre of the board.

It’s not just this SoC design that makes the BCM2835 different to the processor found in your desktop or laptop, however. It also uses a different instruction set architecture (ISA), known as ARM. The Raspberry Pi, by contrast, is designed to run an operating system called GNU/Linux Raspbian. Hereafter referred to simply as Linux. Unlike Windows or OS X, Linux is open source: it’s possible to download the source code for the entire operating system and make whatever changes you desire.

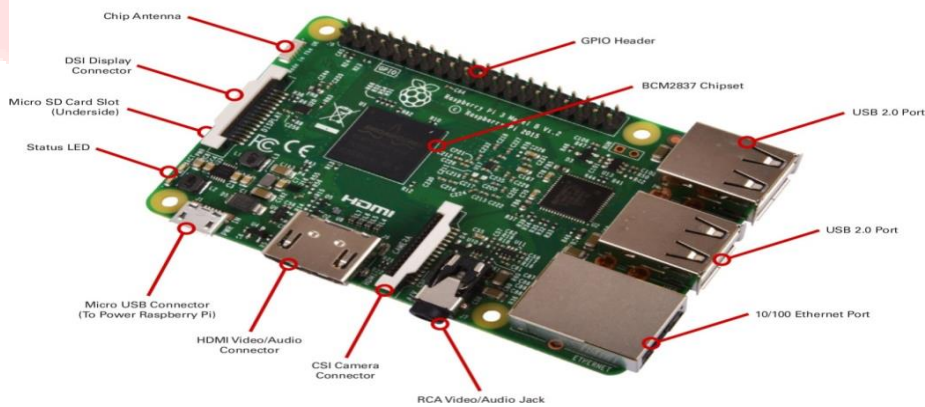

Figure2. Raspberry Pi board

The general specifications of Raspberry PI is shown in below Table 1

Table 1 Specifications of Raspberry Pi

	Model A	Model B	Model B+
Target price:	US\$25	US\$35	
SoC:	Broadcom BCM2835 (CPU, GPU, DSP, SDRAM, and single USB port)		
CPU:	700 MHz ARM1176JZF-S core (ARM11 family, ARMv6)		
Memory (SDRAM):	256 MB (shared with GPU)	512 MB (shared with GPU) as of 15 October 2012	
USB 2.0 ports:	1 (direct from BCM2835 chip)	2 (via the on-board 3-port USB hub)	4 (via the on-board 5-port USB hub)
Video input:	15-pin MIPI camera interface (CSI) connector, used with the Raspberry Pi Camera Add on.		
Video outputs:	Composite RCA (PAL and NTSC) –in model B+ via 4-pole 3.5 mm jack, HDMI (rev 1.3 & 1.4), raw LCD Panels via DS		
Audio outputs:	3.5 mm jack, HDMI, and, as of revision 2 boards, I ² S audio (also potentially for audio input)		
Onboard storage:	SD / MMC / SDIO card slot (3.3 V card power support only)	MicroSD	
Onboard network:	None	10/100 Mbit/Ethernet (8P8C) USB adapter on the third/fifth port of the USB hub	
Low-level peripherals:	8× GPIO, UART, I ² C bus, SPI bus with two chip selects, I ² S audio +3.3 V, +5 V, ground	17× GPIO	
Power ratings:	300 mA (1.5 W)	700 mA (3.5 W)	600 mA (3.0 W)
Size:	85.60 mm × 56 mm (3.370 in × 2.205 in) – not including protruding connectors		

V. SOFTWARE IMPLEMENTATION

5.1 Writing Raspbian to the SD card:

Run the file named Win32DiskImager.exe (in Windows Vista, 7 and 8 we recommend that you right-click this file and choose "Run as administrator") which is illustrated in the below figure5.

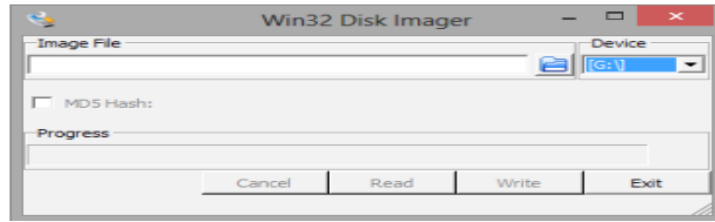

Figure5. Win32 disk imager

- Step1: Plug your SD card into your PC
- Step2: In the folder you made in step 3(b),
- Step3: If the SD card (Device) you are using isn't found automatically then click on the drop down box and select it
- Step4: In the Image File box, choose the Raspbian .img file that you downloaded
- Step5: Click Write
- Step6: After a few minutes you will have an SD card that you can use in your Raspberry Pi

5.2 Idle Python Programming

IDLE is the standard Python development environment Its name is an acronym of "Integrated Development environment". It works well on both Unix and Windows platforms. it has a Python shell window shown in figure6, which gives you access to the Python interactive mode. It also has a file editor that lets you create and edit existing Python source files. The IDLE IDE (Integrated Development Environment) is included with the Raspbian image.

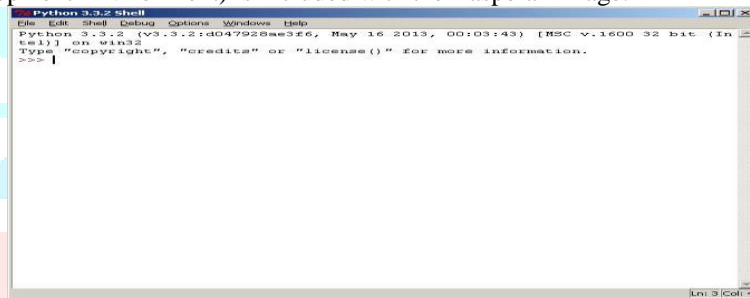

Figure6. Python shell

5.3 Starting Programming With IDLE:

Run IDLE which will open the Python Shell window. Select Menu > File > New Window. To run it select Menu > Run > Run Module and you should see your program appear in the Python Shell window.

- Start IDLE (see screen above). You will then see a window entitled "Python Shell"
- From the Python Shell window, select **New Window** from the **File** menu.
- You will see a window entitled "Untitled"
- From the **File** menu, select **Save As**, and select a folder to save your Python program file

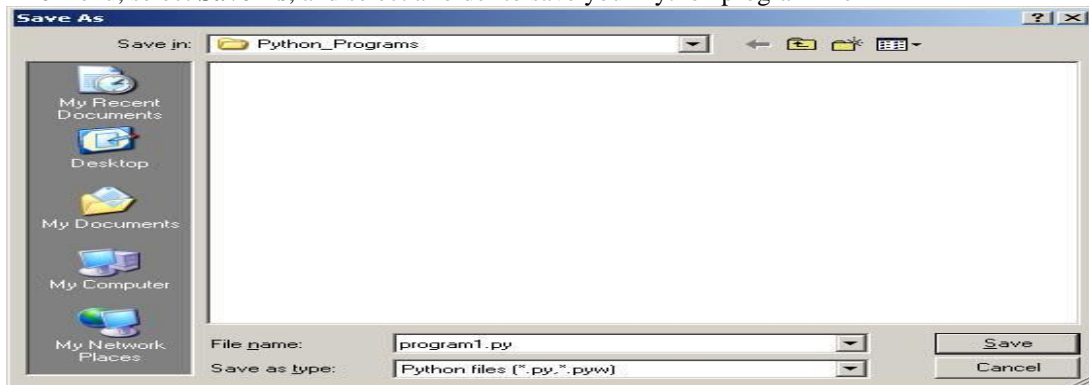

Figure7. Saving Python Program file

- Select a folder to save your file in. In the **File name:** text box, type: program1.py
- Then click on the **Save** button. You will then see a blank editor window ready for you to type in your Python program.
- To run this program, select **Run Module** from the **Run** menu You should see a reminder to save the Source (your program) and Click on OK to save. Then you will see your program running in a Python Shell window.

Python is a widely used, high-level programming language. Its design philosophy emphasizes code readability, and its syntax allows programmers to express concepts in fewer lines of code than would be possible in languages such as C++ or Java. The language provides constructs intended to enable clear programs on both a small and large scale.

VI. RESULTS AND DISCUSSION

The below figure8 shows the hardware connection of the proposed system. Here GPS Module is connected to the RASPBERRY PI which is used to navigate the location of the bus stops. In this system, power supply is given to the RASPBERRY PI.

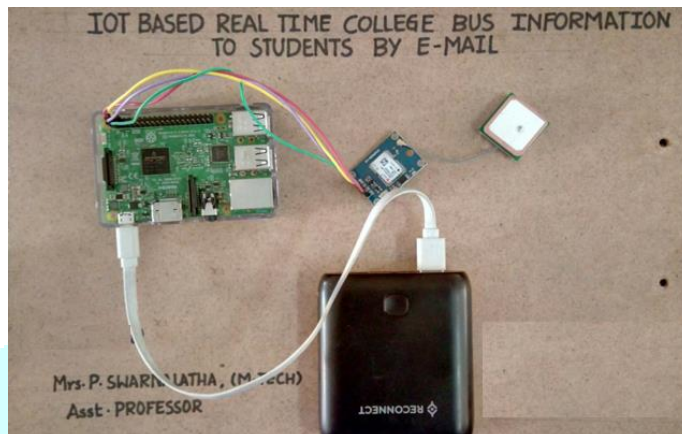

Figure8. Hardware Connection

The figure9 shows that the student gets an E-mail alert regarding their respective bus stops. Due to this student can know the information about the bus when it was arrived to their stop.

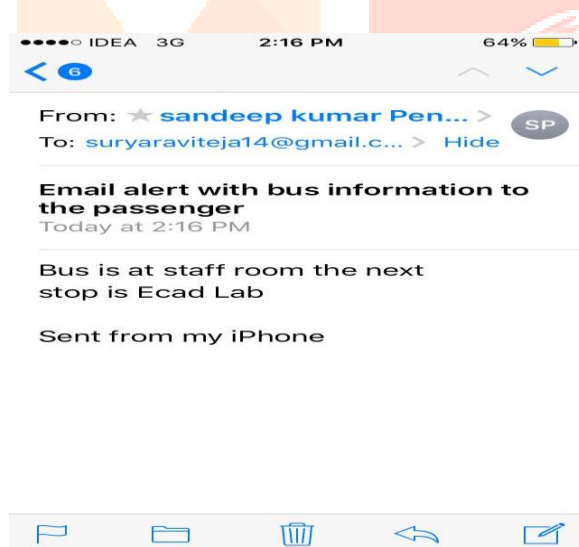

Figure9. E-mail alert

VII. CONCLUSION:

This paper presents the information to the users using GPS and raspberry pi. It is used for reducing human effort who are experienced in waiting at their respective bus stops. We send alert as e-mail to the students by using GPS module which is continuously tracking the location with respect to the student stops.

The proposed system is intended to play an important role in real time monitoring and also intended to provide safety and secure solution to the students and parents. An e-mail alert is sent to the parents whenever their child boards the college bus and also when the student is dropped from college at the dropping point. Whenever there is college bus accident, the system provides the condition of students by an E-mail alert.

REFERENCES:

- [1]Progress in speech synthesis by JAN P.H. VAN SANTAN
- [2] GSM"IS-95(CDMA)andGSM(TDMA)".Retrieved2011-02-03.
- [3] Suhas R. Mache, ManasiR.Baheti, C. NamrataMahender, "Review on Text-to-speech Synthesizer", International Journal of Advanced Research In Computer And Communication Engineering, vol-4, Issue 8, August 2015
- [4] ItunuoluwaIsewon, JeliliiOyelade, OlufunkeOladipupo "Design and Implementation of Text to Speech Conversion for Visually Impaired People" April-2014
- [5] Abhijit V. Bapat, Lalit K. Nagalkar, " Phonetic Speech for Speech to Text Conversion",published in Industrial and Information System,ICIIS-2008.
- [6]Teo Boon Chen, D. Ghosh, S. Ranganath,"Video – Text extraction and recognition" published in IEEE Region 10 conference Tencon-2004
- [7] Yuksekkaya, B.; Kayalar, A.A.; Tosun, M.B.; Ozcan, M.K.; Alkar, A.Z., "A GSM, internet and speech controlled wireless interactive home automation system,"
- [8] Maik Schmidt. Raspberry Pi. A Quick Start Guide. Dallas, Texas: The Pragmatic Bookshelf, pp. 11-42 , 2012.
- [9] espeak.sf.net/test/latest.html, www.raspberrypi.org/resources/learn.
- [10]] Learn to python program by codyJackson.
- [11]Programming the Raspberry Pi: Getting Started with Python by simonmon.
- [12]Rajesh kanessti, "Design and Implementation of Text to Speech Extension for Internet Browser", published in Texas A&M university Corpus Christi, Texas-2009
- [13] E.J.Nagle, J.G. Chiquito, "Text-to-speech conversion system for Brazilian Portuguese using a formant based synthesis technique", INSPEC, August-2005

