

# First order ordinary differential equation in heat transfer analysis

<sup>1</sup>Ashwini.N.Kempannavar,<sup>2</sup>Rashmi.B.Bhavi, <sup>3</sup>Amatush Shifa

<sup>1,2</sup> Faculty in Mathematics Dept, Akkamahadevi Women's University, Vijayapur, <sup>3</sup> Research Student

**Abstract:** In this paper we used first order ordinary differential equation in heat transfer analysis. The main purpose of this paper is to demonstrate how first order ordinary differential equation techniques can be useful in heat transmission such as heat conduction in solids, heat convection in fluids, radiation of heat in space. It teaches that first order ordinary differential equation can be understood from heat transfer analysis in solids, fluids, space. In fact it is too general for many applications in science and engineering field. Many of the parameters in our universe interact through differential equation. In this paper we will discuss the first order ordinary differential equation is a technique for analyzing the heat transmission.

**Index terms:** Heat flux, refrigeration, solid slab, bulk fluid.

**I. Introduction:** A differential equation is a mathematical equation that relates some function of one or more variables with its derivatives. Differential equations arise whenever a deterministic relation involving some continuously varying quantities (modeled by functions) and their rates of change in space and/or time (expressed as derivatives) is known or postulated. Because such relations are extremely common, differential equations play a prominent role in many disciplines including engineering, physics, economics, and biology. A differential equation is an equation between specified derivative on an unknown function, its values, and known quantities and functions. Many physical laws are most simply and naturally formulated as differential equations (or DEs, as we will write for short). For this reason, DEs have been studied by the greatest mathematicians and mathematical physicists since the time of Newton. Ordinary differential equations are DEs whose unknowns are functions of a single variable; they arise most commonly in the study of dynamical systems and electrical networks. They are much easier to treat those partial differential equations, whose unknown functions depend on two or more independent variables.

**1.1 History:** Historically, differential equations arose from humanity's interest in and curiosity about the nature of the world in which we live. This interest includes both physical processes occurring on the earth as well as the movements of heavenly bodies. The theory of differential equations dates back to the beginnings of the calculus with Newton (1642-1727) and Leibnitz (1646-1716) in the 17<sup>th</sup> century. Following Newton and Leibnitz come the names of the Bernoulli brothers Jacob (1654-1705) and Johann (1667-1748) and Johan's son Daniel (1700-1782). Differential equations occur in connection with numerous problems that are encountered in the various branches of science and engineering. We indicate a few such problems in the following list.

1. The problem of determining heat transfer in a rod or in a slab.
2. The study of draining a tank.
3. The study of reactions of chemicals.
4. The problem of determining the vibrations of a wire or a membrane etc...

Many laws of nature find their natural expression in the language of differential equation. Differential equations are the language of nature. Applications of differential equations also abound in mathematics itself, in geometry, and harmonic analysis in modeling. It is not difficult to preserve why differential equations arise so rapidly in the sciences. If  $y=f(x)$  is a given function then the derivative  $\frac{df}{dx}$  can be interpreted as the rate of change of "f" with respect to x. In any process of nature that is by the laws of nature. When this relationship is expressed in mathematical notation, the result is usually a differential equation.

**II. Definition of differential equation:** A simple definition for differential equation is a differential equation is an equation which involves derivatives, or An equation involving a dependent variable and its differential co-efficient and one or more independent variables are called a differential equation.

Examples:

- 1)  $\frac{dy}{dx} + \frac{y}{x} = \sin x$
- 2)  $\frac{d^2y}{dx^2} + 3\frac{dy}{dx} + 2y = 0$
- 3)  $xy^1 + y = 4$

**2.1 Ordinary differential equations:** An ordinary differential equation (ODE) is a differential equation in which the unknown function (also known as the dependent variable) is a function of a single independent variable.

For example:

$$x^2 \frac{d^2y}{dx^2} + x \frac{dy}{dx} + (x^2 - a^2) = 0 \quad (\text{Bessel's equation})$$

$$\frac{dy}{dx} + y = y^2 \quad (\text{Bernoulli's equation})$$

$$\frac{d^2y}{dx^2} = xy \quad (\text{Airy's equation})$$

$$\frac{d^2y}{dx^2} - (1 - y^2) \frac{dy}{dx} + y = 0 \quad (\text{Van der Pol's equation})$$

**2.2 Partial differential equations:** A partial differential equation (PDE) is a differential equation in which the unknown function is a function of multiple independent variables and the equation involves its partial derivatives.

For example:

$$\frac{\partial u}{\partial x} + \frac{\partial u}{\partial y} = 0 \quad (\text{Flux equation})$$

$$\frac{\partial u}{\partial t} = \frac{\partial^2 u}{\partial x^2}$$

$$\frac{\partial^2 u}{\partial t^2} = \frac{\partial^2 u}{\partial x^2}$$

(Heat equation)

(Wave equation)

**2.3 First order differential equation equations:** A differential equation of the standard form  $\frac{dy}{dx} = f(x, y)$  is known as first order differential equation. The general form of first order differential equation is

$$P_n(x, y) \left(\frac{dy}{dx}\right)^n + P_{n-1}(x, y) \left(\frac{dy}{dx}\right)^{n-1} + P_{n-2}(x, y) \left(\frac{dy}{dx}\right)^{n-2} + \dots + P_1(x, y) \left(\frac{dy}{dx}\right) + P_0(x, y) = 0$$

Ex: 1)  $\frac{dy}{dx} + x^2 = x^4 y$   
 2)  $(x+y)^3 \frac{dy}{dx} = a$

**III. Heat transfer analysis:**

The Three Modes of Heat Transmission:

- Heat conduction in solids
- Radiation of heat in space
- Heat convection in fluids

**3.1 Review of Fourier Law for Heat Conduction in Solids**

- Heat flows in solids by conduction
- Heat flows from the part of solid at higher temperature to the part with low temperature - a situation similar to water flow from higher elevation to low elevation
- Thus, there is definite relationship between heat flow (Q) and the temperature difference ( $\Delta T$ ) in the solid
- Relating the Q and  $\Delta T$  is what the Fourier law of heat conduction is all about

**3.1.1 Derivation of Fourier Law of Heat Conduction:**

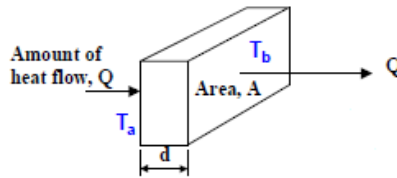

A solid slab: With the left surface maintained at temperature  $T_a$  and the right surface at  $T_b$ . Heat will flow from the left to the right surface if  $T_a > T_b$ .

By observations, we can formulate the total amount of heat flow (Q) through the thickness of the slab as:

$$Q \propto \frac{A(T_a - T_b)t}{d}$$

Where  $A$  = the area to which heat flows;  $t$  = time allowing heat flow; and  $d$  = the distance of heat flow  
 Replacing the  $\propto$  sign in the above expression by an = sign and a constant  $k$ , leads to:

$$Q = k \frac{A(T_a - T_b)t}{d} \tag{1}$$

The constant  $k$  in Equation (1) is “thermal conductivity” – treated as a property of the solid material with a unit: Btu/in-s-<sup>0</sup>F or W/m-<sup>0</sup>C

The amount of total heat flow in a solid as expressed in Equation (1) is useful, but makes less engineering sense without specifying the area  $A$  and time  $t$  in the heat transfer process.

Consequently, the “Heat flux” ( $q$ ) – a sense of the intensity of heat conduction ( $q$ ) is used more frequently in engineering analyses.

From Equation (1), we may define the heat flux as:

$$q = \frac{Q}{At} = k \frac{(T_a - T_b)}{d} \tag{2}$$

with a unit of: Btu/in<sup>2</sup>-s, or W/cm<sup>2</sup>

We realize Equation (2) is derived from a situation of heat flow through a thickness of a slab with distinct temperatures at both surfaces. In a situation the temperature variation in the solid is continuous, by function  $T(x)$ , as illustrated below:

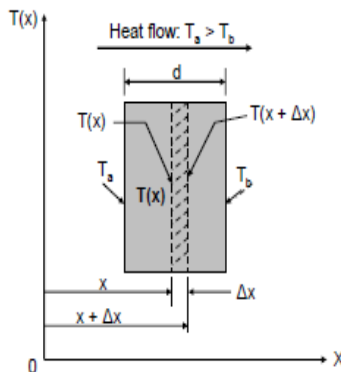

By following the expression in equation (2), we will have:

$$q = k \frac{T(x) - T(x + \Delta x)}{\Delta x} = -k \frac{T(x + \Delta x) - T(x)}{\Delta x} \tag{3}$$

If function  $T(x)$  is a continuous varying function w.r.t variable  $x$ , (meaning  $\Delta x \rightarrow 0$ ), we will have the following from equation (3):

$$q(x) = \lim_{\Delta x \rightarrow 0} \left[ -k \frac{T(x + \Delta x) - T(x)}{\Delta x} \right] = -k \frac{dT(x)}{dx} \tag{4}$$

Equation (4) is the mathematical expression of Fourier Law of Heat Conduction in the x-direction.

**Example 1)** A metal rod has a cross-sectional area  $1200 \text{ mm}^2$  and  $2\text{m}$  in length. It is thermally insulated in its circumference, with one end being in contact with a heat source supplying heat at  $10 \text{ kW}$ , and the other end maintained at  $50^\circ\text{C}$ . Determine the temperature distribution in the rod, if the thermal conductivity of the rod material is  $k = 100 \text{ kW/m}\cdot^\circ\text{C}$ .

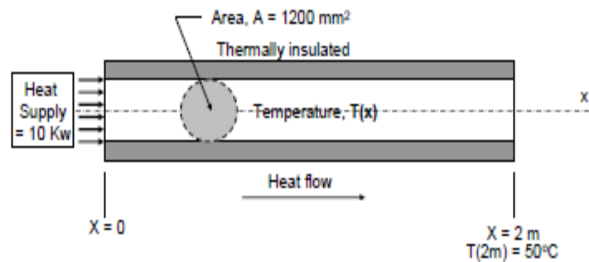

### Solution:

The total heat flow  $Q$  per unit time  $t$  ( $Q/t$ ) in the rod is given by the heat source to the left end, i.e.  $10 \text{ kW}$ .

Because heat flux is  $q = Q/(At)$  as shown in Equation (2), we have  $(Q/t) = qA = 10 \text{ kW}$

But the Fourier Law of heat conduction requires  $q(x) = -k \frac{dT(x)}{dx}$  as in Equation (4), we thus have:

$$Q = qA = -kA \frac{dT(x)}{dx} \quad \frac{dT(x)}{dx} = -\frac{Q}{kA} = -\frac{10}{100(1200 \times 10^{-6})} = -83.33 \text{ }^\circ\text{C/m} \quad (\text{a})$$

Expression in (a) is a 1<sup>st</sup> order differential equation, and its solution is:

$$T(x) = -83.33x + c \quad (\text{b})$$

If we use the condition:  $T(2) = 50^\circ\text{C}$ , we will find  $c = 216.67$ , which leads to the complete solution:

$$T(x) = 216.67 - 83.33x$$

### 3.2 Heat flux in space:

Expression in 3-dimensional form

- Heat flows in the direction of decreasing temperature in a solid.
- In solids with temperature variations in all direction, heat will flow in all directions.
- So, in general, there can be 3-dimensional heat flow in solids.
- This leads to 3-dimensional formulation of heat flux.
- Heat flux  $q(\mathbf{r},t)$  is a vectorial quantity, with  $\mathbf{r}$  = position vector, representing  $(x,y,z)$

The magnitude of vector  $q(\mathbf{r},t)$  is:

$$q(x,y,z,t) = \sqrt{q_x^2 + q_y^2 + q_z^2} \quad (\text{5})$$

With the components along respective  $x$ ,  $y$ , &  $z$ -co-ordinates:

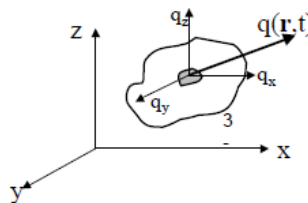

$$q_x = -k_x \frac{\partial T(x,y,z,t)}{\partial x}$$

Position vector:

$$q_y = -k_y \frac{\partial T(x,y,z,t)}{\partial y}$$

$\mathbf{r}(x,y,z)$

$$q_z = -k_z \frac{\partial T(x,y,z,t)}{\partial z}$$

In general, the heat flux vector in the Fourier Law of Heat Conduction can be expressed as:

$$\mathbf{q}(\mathbf{r},t) = -k\nabla T(\mathbf{r},t) \quad (\text{6})$$

**3.2.1 Heat flux in a 2-D Space:** Tubes with longitudinal fins are common in many heat exchangers and boilers for effective heat exchange between the hot fluids inside the tube to cooler fluids outside:

The heat inside the tube flows along the plate-fins to the cool contacting fluid outside.



It is desirable to analyze how effective heat can flow in the cross-section of the fin.

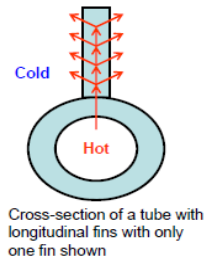

Fins are also used to conduct heat from the hot inside of an internal combustion engine to the outside cool air in a motor cycle:



**Heat Spreaders in Microelectronics Cooling:**

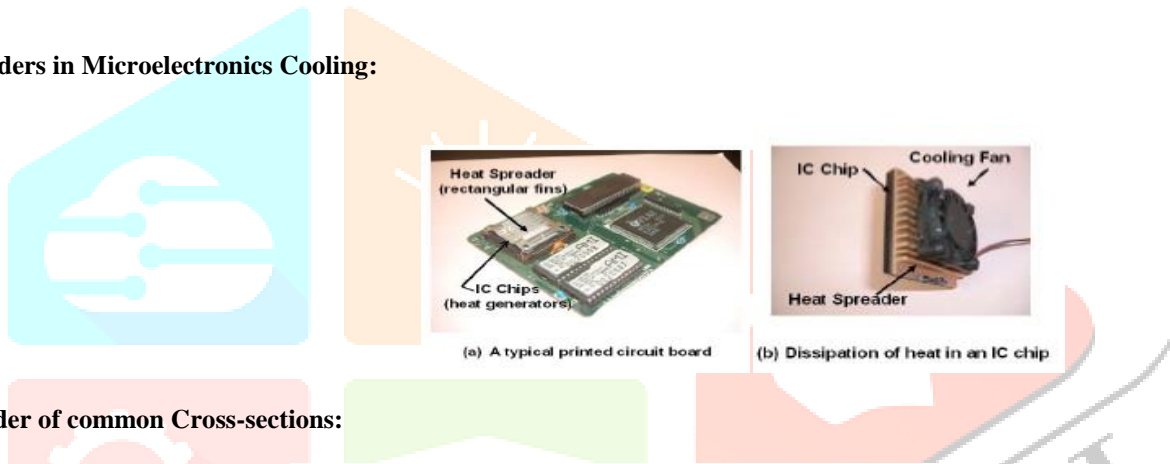

**Heat spreader of common Cross-sections:**

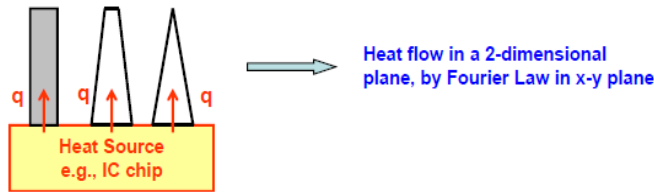

**Sign of Heat Flux:**

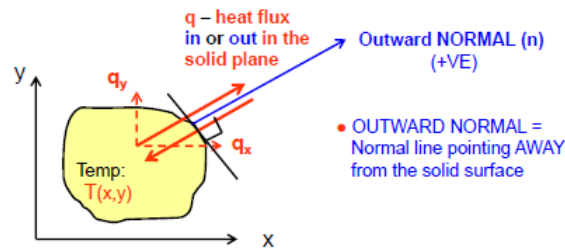

Sign of Outward Normal (n)	q along n?	Sign of q in Fourier Law
+	Yes	-
+	No	+
-	Yes	+
-	No	-

**3.3 Review of Newton’s Cooling Law for Heat Convection in Fluids:**

- Heat flow (transmission) in fluid by convection
- Heat flow from higher temperature end to low temperature end
- Motion of fluids causes heat convection
- as a rule-of-thumb, the amount of heat transmission by convection is proportional to the velocity of the moving fluid

**3.3.1 Mathematical expression of heat convection – The Newton’s cooling law:**

A fluid of non-uniform temperature in a container:

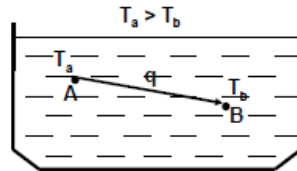

Heat flows from Ta to Tb with Ta > Tb. The heat flux between A and B can be expressed by:

$$q \propto (T_a - T_b) = h(T_a - T_b) \tag{7}$$

Where h = heat transfer coefficient (W/m<sup>2</sup>·°C)

The heat transfer coefficient h in Equation (7) is normally determined by empirical expression, with its values relating to the Reynolds number (Re) of the moving fluid. The Reynolds number is expressed as:

$$Re = \frac{\rho Lv}{\mu}$$

With ρ = mass density of the fluid; L = characteristic length of the fluid flow, e.g., the diameter of a circular pipe, or the length of a flat plate; v = velocity of the moving fluid; μ = dynamic viscosity of the fluid.

**3.3.2 Heat Transfer in Solids Submerged In Fluids:**

- there are numerous examples of which solids are in contact with fluids at different temperatures.

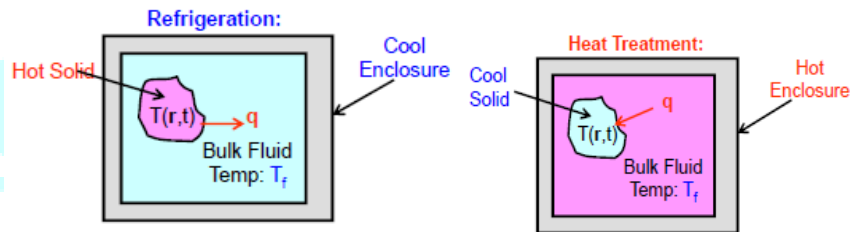

- In such cases, there is heat flow between the contacting solid and fluid.
  - But the physical laws governing heat flow in solids is the Fourier Law and that in fluids by the Newton’s Cooling Law
- So, mathematical modeling for the contacting surface in this situation requires the use of both Fourier Law and Newton’s Cooling Law:

**3.3.3 Mathematical Modeling of Small Solids in Refrigeration and Heating:**

We will simplify with assumptions on:

- The solid is initially at temperature T<sub>0</sub>
- the solid is so small that it has uniform temperature, but its temperature varies with time t, i.e., T = T(t)
- the time t begins at the instant that the solid is submerged in the fluid at a different temperature Tf
- Variation of temperature in the solid is attributed by the heat supplied or Removed by the fluid.

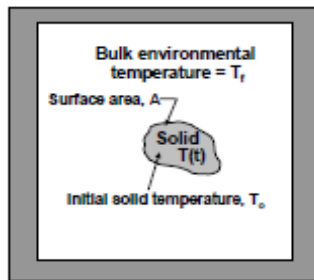

**3.3.4 Derivation of Math Model for Heat Transfer in Solids Submerged in Fluids:**

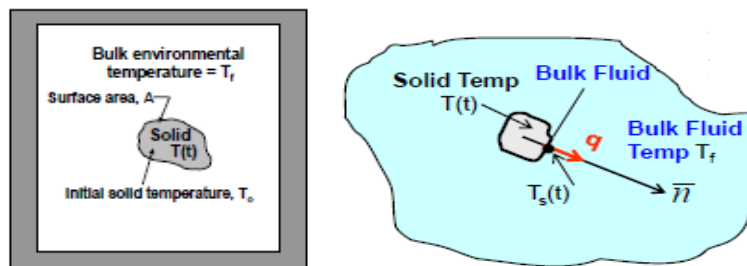

The solid is small, so the surface temperature Ts (t) = T (t), the solid temperature. Heat flows in the fluid, when T(t) ≠ Tf, the bulk fluid temperature.

Heat flows in the fluid follows the Newton Cooling Law expressed in Equation (7), i.e.:

$$q = h [T_s (t) - T_f] = h [T (t) - T_f] \tag{a}$$

Where h = heat transfer coefficient between the solid and the bulk fluid

From the First Law of Thermodynamics, the heat required to produce temperature change in a solid ΔT(t) during time period Δt can be obtained by the principle:

Change in internal energy of the small solid during  $\Delta t =$  Net heat flow from the small solid to the surrounding fluid during  $\Delta t$

$$-\rho c V \Delta T(t) = Q = q A_s \Delta t = h A_s [T(t) - T_f] \Delta t \quad (b)$$

Where  $\rho =$  mass density of the solid,  $c =$  specific heat of solid,

$V =$  volume of the solid,  $A_s =$  contacting surface between solid and bulk fluid.

From Equation (b), we express the rate of temperature change in the solid to be:

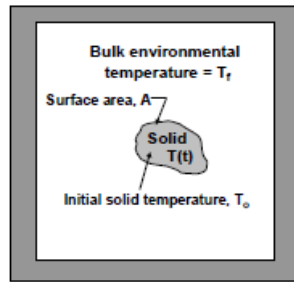

$$\frac{\Delta T(t)}{\Delta t} = -\frac{h}{\rho c V} A_s [T(t) - T_f] \quad (c)$$

Since  $h$ ,  $\rho$ ,  $c$  and  $V$  on the right-hand-side of Equation (c) are constant, we may lump these three constant to let:

$$\alpha = \frac{h}{\rho c V} \quad (d)$$

With a unit ( $/m^2 \cdot s$ )

Equation (c) is thus expressed as:

$$\frac{\Delta T(t)}{\Delta t} = -\alpha A_s [T(t) - T_f] \quad (e)$$

Since the change of the temperature of the submerged solid  $T(t)$  is continuous with respect to time  $t$ ,

i.e.,  $\Delta t \rightarrow 0$ , and if we replace the contact surface area  $A_s$  to a generic symbol  $A$ , we can express Equation (e) in the form of a 1st order differential equation:

$$\frac{dT(t)}{dt} = -\alpha A [T(t) - T_f] \quad (8)$$

With an initial condition  $T(t)_{at t=0} = T(0) = T_0$

#### IV. CONCLUSION:

The subject of differential equation is well established part of mathematics and many recent advances in mathematics paralleled by a renewed and flourishing interaction between mathematics, the sciences, and engineering, have again shown the many phenomena in applied sciences will yield some mathematical explanation of these phenomena. It is a deniable fact that differential equations form the most important branch of modern mathematics and in fact occupy the position at the center of both pure and applied mathematics. In this paper, we analyzed a brief history about ordinary differential equations. This is followed by a discussion about how differential equations arise naturally by different mathematicians. We studied brief introduction to the definitions and terminologies of Differential Equations, in that order and degree and types of differential equations included.

#### V. REFERENCES:

- 1) M. Braun, *Differential Equations and their Applications*, Springer-Verlag, Berlin (1975).
- 2) Richard Bronson, *Differential Equations*.
- 3) *Differential Equations* by M.L. Khanna.
- 4) *Introduction to Differential Equations* by Jeffrey R. Chasnov.
- 5) *Differential Equations and their applications* by Dr. Zafar Ahsan
- 6) *Applications of first and second order Differential Equations in Mechanical Engineering Analysis* by Prof. Tai-Ran Hsu.
- 7) "Modeling with first order Differential Equation" by Dennis G Zill and Michael R Gullen.
- 8) *Applications to First Order Differential Equations: Growth and Decay Models* by Dr. Marcel B. Finan
- 9) "Differential Equations - A Modeling approach" by Giordano.
- 10) Paul Blanchard, Robert L. Devaney, Glenn R. Hall, *Differential Equations (Preliminary Edition)*, PWS Publishing, Boston, 1996.
- 11) William H. Boyce and Richard C. Diprima, *Elementary Differential Equations and Boundary Value Problems (6th Edition)*, Wiley, New York, 1996.
- 12) C.H. Edwards, Jr., David E. Penney, *Elementary Differential Equations with Applications (Third Edition)*, Prentice-Hall, Englewood Cliffs, NJ, 1996.
- 13) R. Kent Nagle and Edward B. Saff, *Fundamentals of Differential Equations (Third Edition)*, Addison Wesley, Reading, MA, 1993.
- 14) [Boston University Ordinary Differential Equations Project](#) (Developed book by Blanchard, Devaney, and Hall above)
- 15) [Consortium of Ordinary Differential Equations Experiments](#) (Maintained by Harvey Mudd College) Has lots of information for instructors.
- 16) [Differential Equations Resource Center](#) (Maintained by PWS Publishing)