

# Design of an Ultra-Wide Band Planar Antenna with Triple Band-Notched Characteristics

Y.supriya<sup>1</sup>, T.Rajesh<sup>1</sup>, Sk.Sharuk Khan<sup>1</sup>, P.Kavya<sup>1</sup>, S.Hemanth<sup>1</sup>, B.Kiran Kumar<sup>2</sup>

<sup>1</sup>Students    <sup>2</sup>Professor

Departement of Electronics and Communication Engineering,  
St.Ann's College of Engineering and Technology, Chirala, A.P.

## Abstract:

In this paper, we are proposed an ultra wide band antenna. The ultra wide band is operated from 3.1 to 10.6 GHZ approved by the Federal Communication Commission (FCC) in 2002. The antenna consists of complimentary split ring resonator(CSRR) structure and split ring resonator(SRR) structure and EBG Structure in the ground plane are used to achieve 4.10/5.90/7.42GHZ triple band notched characteristics. The measured result shows that the proposed antenna can achieve the voltage standing wave ratio (VSWR) requirement of less than 2.0 with triple band –rejection performance of 3.7-4.2GHZ, 5.1-6.19GHZ and 7.2-7.7GHZ.

## Key Words:

Split Ring Resonator(SRR) structure, triple-band notched performance, Complementary Split Ring resonator (CSRR) structure, UWB antenna.

## Introduction:

In this article, Ultra Wide band planar antenna is designed with c & inverted c-shape on annular path and SRR slots and EBG slot on ground plane to generate 3.7-4.2 and 5.1-6.19 and 7.1-7.7GHz is achieved respectively[1-2]. The CSRR method is proposed because it has property of negative effective permittivity[3]and can be used to reject unwanted frequencies. Here from these annular patch we can generate triple –band notch's are obtained and since from past few years, various techniques has been came into existence but most of the antennas are able to generate only one notch but these design is made to generate more than three notch-bands. Moreover the triple band notched performance can be varied by adjusting the values of c shape slot and SRR dimensions and CSRR dimensions.

The UWB antennas plays an important role in recent years due to its advantages like high channel capacity, security, reliable data, low transmission power consumption. In 2002 ,Federal Communication commission approved that over the commercial frequencies from 3.1 to 10.6GHz[4].Due these attractive and useful merits with UWB system the technologies are moving towards these narrow-band systems.

The proposed antenna can be used for various applications as X-band satellite applications and to achieve the frequency as 7.17-7.71GHZ by using the slot as a SRR[5-7] structure placed in a substrate. And for the C-Band system applications the achieve the frequency as 3.7-4.2GHZ by using the slot as circular CSRR[8-10] structure in the patch. The final application for the proposed antenna is WLAN application[11-12] ,the frequency range for this application is 5.1-6.19GHZ is achieved by introducing slot as EBG structure in the ground plane.

## Antenna Design:

Schematic configuration of the proposed antenna is shown in figure 1 .the antenna is designed using copper and FR-4 materials. Copper is used to design the ground plane and the conducting patch on the substrate while FR-4 is used to design the substrate. We consider the 15x15x0.035 mm<sup>3</sup> for ground. For substrate we used 15x15x1.6 mm<sup>3</sup>.the relative permittivity of the substrate is 4.4. For patch the thickness is 0.035 mm . A rectangular notch with size of 3mm×2.5mm on the top of the ground is proposed to improve impedance bandwidth of the presented antenna. The center of CSRR has been displaced by 1.5mm from the center of the microstrip.

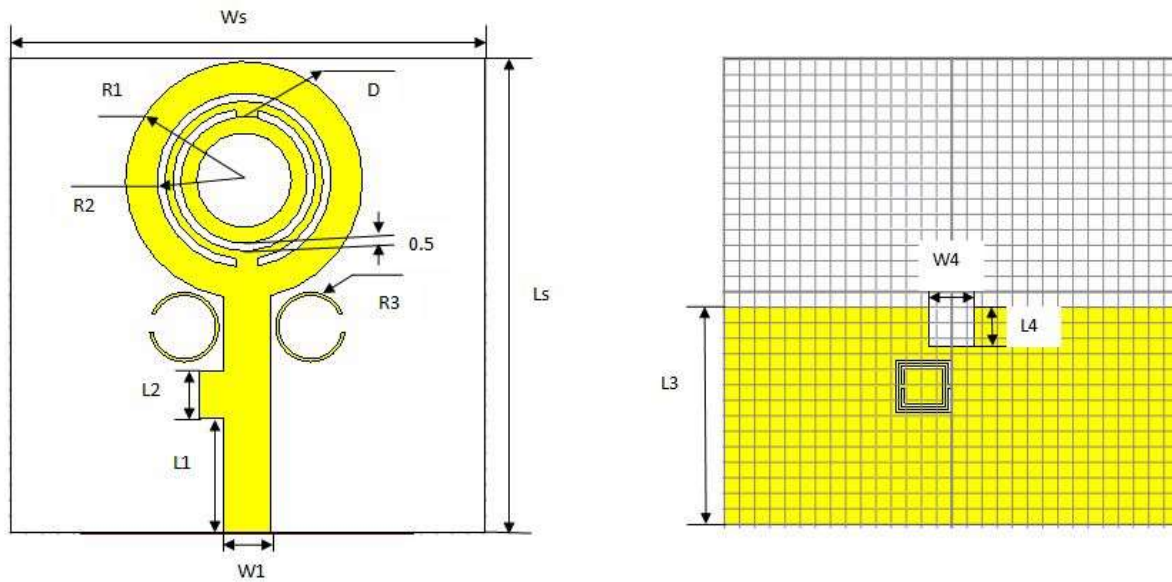

**Top View**

**Bottom View**

**Figure1**

Ls:Length of substrate=30mm

Ws:Width of substrate=30mm

R1:Radius of circle1=7.5mm

R2:Radius of circle2=5.5mm

R3:Radius of circle3=2.2mm

D:Distance between the end to end=1.7mm

L1:Distance between Ground to chip=7.8mm

W1:Width of the feeding=3mm

L2:Length of the chip=3mm

L3:Length of the Ground plane=14mm

L4:Length of Ground chip=2.5mm

W4:Width of Ground chip=3mm

**Results And Discussion:**

This antenna was developed by using CST microwave studio 2017 to perform simulation and optimization process and also to measure VSWR and return losses with accurate range can be possible with the help of these studio. The S- parameters are shown in figure2, the VSWR are shown in figure3. And the radiation pattern also obtained using these software without any changes to radiated frequencies ranges.

Here the triple band notches which are above 10db and having above 2.0 with good performance of successful rejection bands of 3.7-4.2GHZ, 5.1-6.17GHZ and 7.17-7.71GHZ

**S-Parameters:**

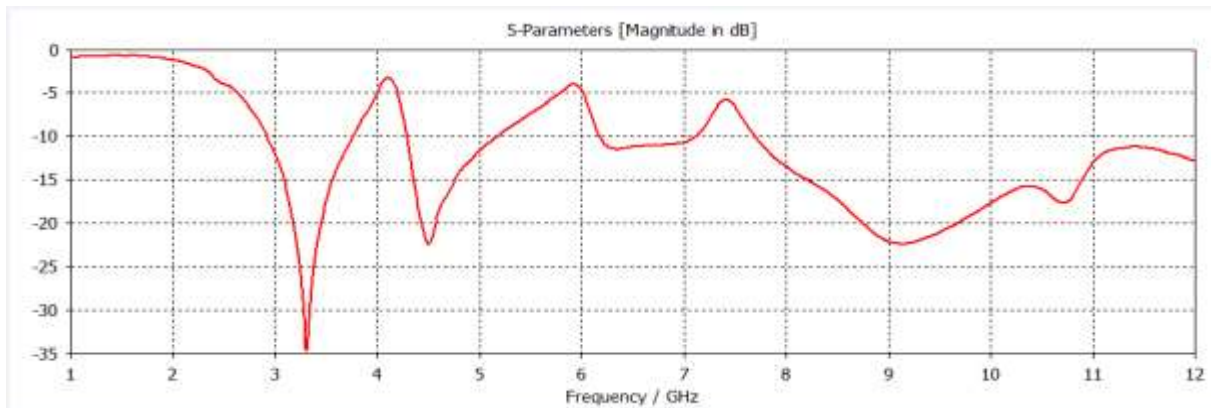

**VSWR:**

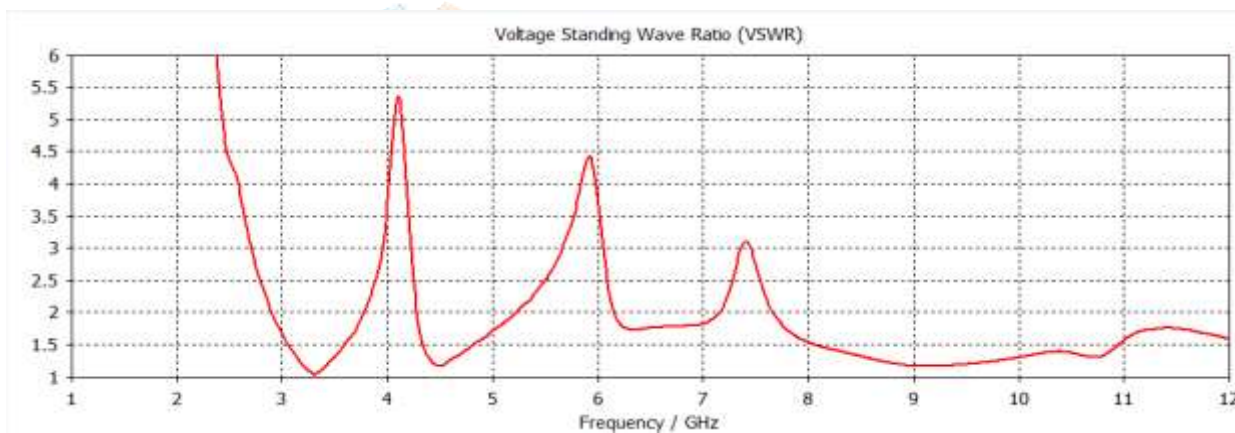

**Surface currents:**

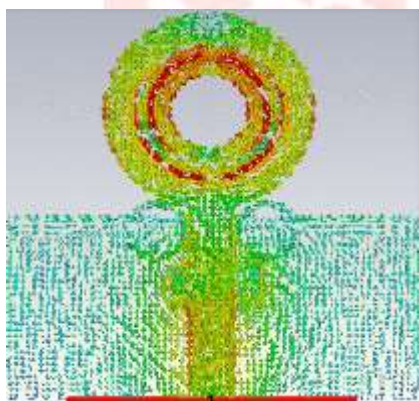

Surface current for 3.7-4.2GHz

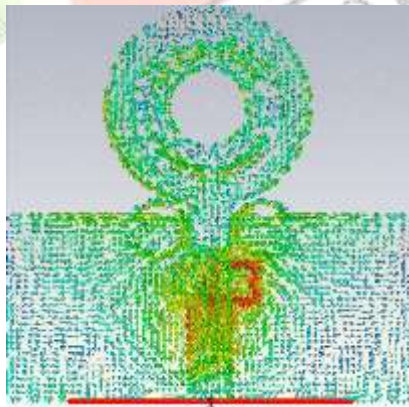

Surface Current for 5.1-6.19GHz



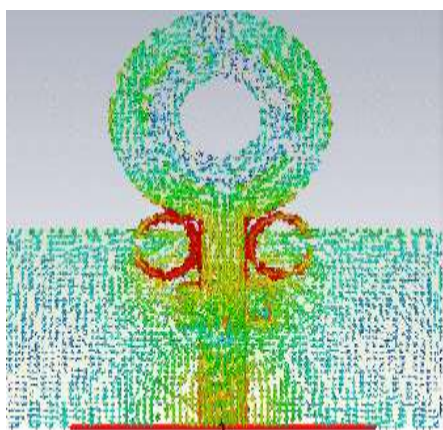

Surface Current for 7.17-7.71GHz

**Radiation Pattern:**

**Radiation Pattern in E-field at 3.31GHz**

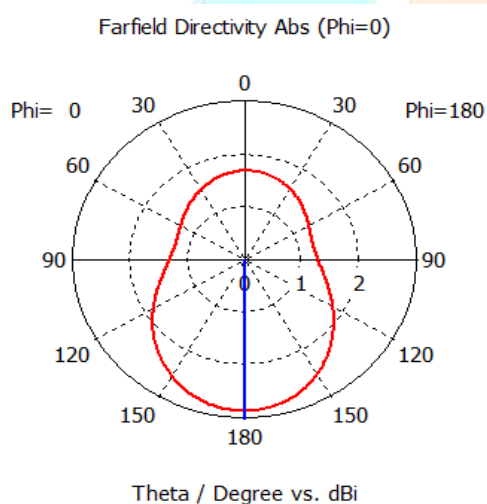

**Radiation Pattern in H-field at 3.31GHz**

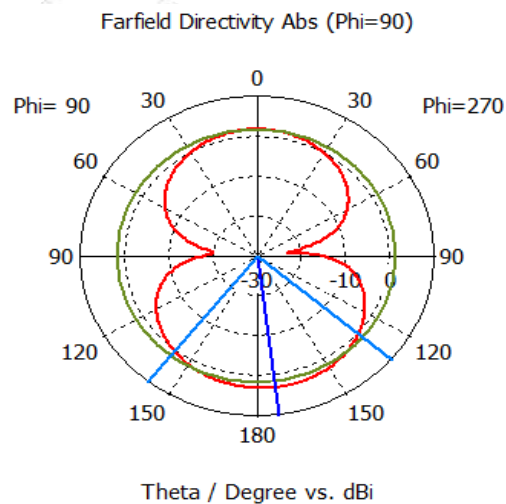

**Radiation Pattern in E-field at 4.10GHz**

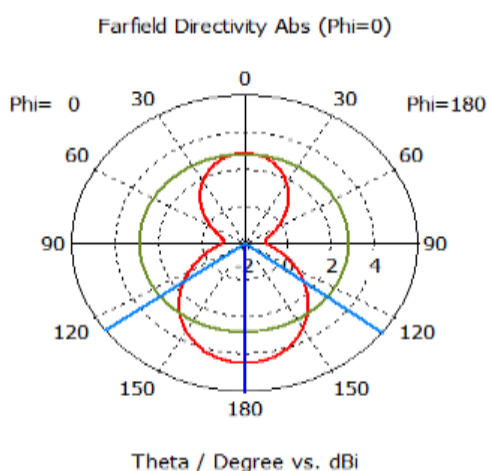

**Radiation Pattern in H-field at 4.10GHz**

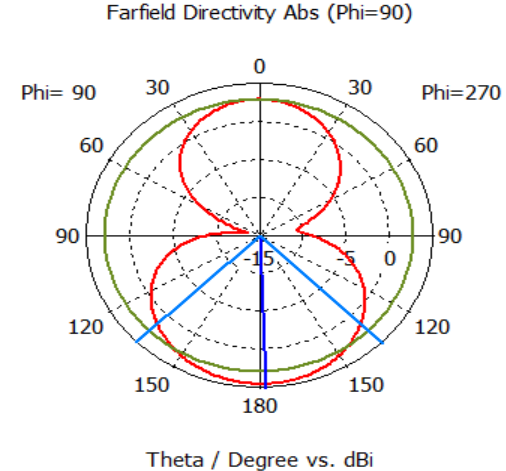

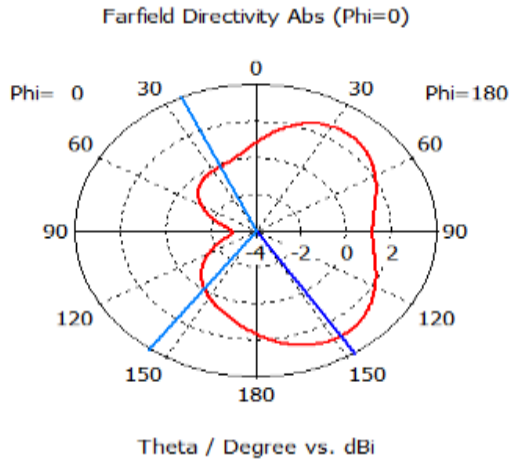
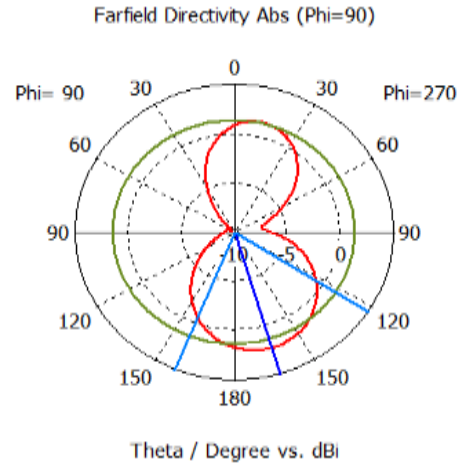
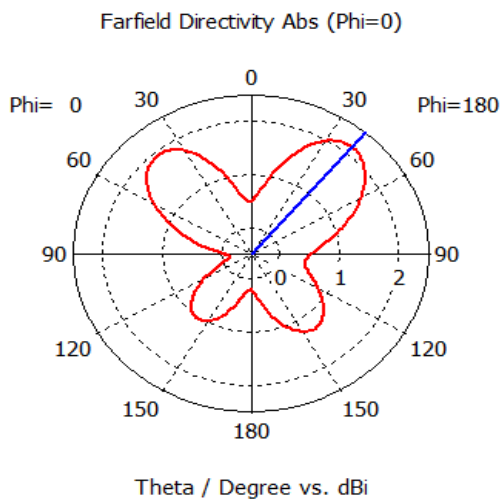
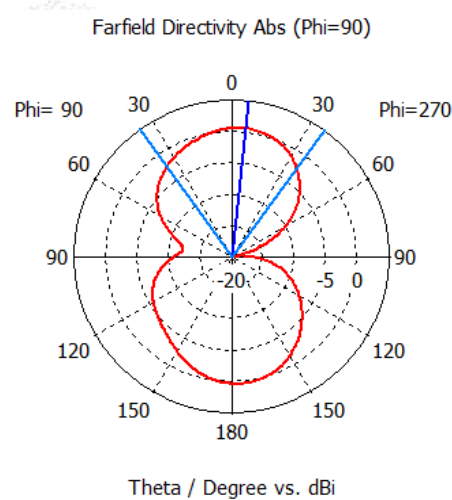
**Radiation Pattern in E-field at 5.9GHZ****Radiation Pattern in H-field at 3.31GHZ****Radiation Pattern in E-field at 7.41GHZ****Radiation Pattern in H-field at 3.31GHZ****Conclusion:**

In this paper, an UWB planar antenna is designed to operate at a triple-band notched performance of 4.10GHz, 5.90GHz and 7.42GHz. The developed antenna is used for various applications due to its narrow band performance and better VSWR range. The important antenna parameters like S-parameters, VSWR, surface current and radiation pattern of the developed antenna are presented. The developed antenna can be used for applications such as for satellite communications, C-band systems, WLAN systems.

**References:**

1. First report and order, Revision of part 15 of the commission's rule regarding ultra-wideband transmission system FCC 02-48, Federal Communications Commission, 2002.
2. V.N Koteswara Rao. Devana, a novel UWB monopole antenna With defected ground structure.
3. F.Falcone, T.Lopetegi, and J.D.Baena, Effective negative stopband microstrip lines based complementary split ring resonators, IEEE Microwave Wireless Component Lett 14(2004), 280-282.

4. V.N Koteswara Rao. Devana, Novel UWB Monopole Antenna With Band Notched Characteristics.
5. Abid Ali and Zhirun Hu, Metamaterial resonator based wave propagation notch for ultrawide band filter application IEEE Antennas and Wireless propagation Lett 7(2008),210-212.
6. Nita Kalambe, Prof. Dhruv Thakur, Prof. Shubhankar Paul, Review of Microstrip Patch Antenna Using UWB for Wireless Communication Devices, International Journal of Computer Science and Mobile Computing(2015).
7. J. Kim, C.S Cho, and J.W. Lee, 5.2GHz notched ultra-wideband antenna using slot-type SRR, Electron Lett 42(2006), 315-316.
8. Bashar B. Qas Elias, Hussein Mohammed AL-Dahhan, Bandwidth Enhancement of A microstrip Patch Antenna for C-band and X- band By Using New Structure of Defected Ground Technique, International Journal of Computer Science and Mobile Computing(2015).
9. J. Zhou, B.H. Sun, Q.Zh. Liu, and J.Y. Deng, Implementation and investigation of U-shaped aperture UWB antenna with dual band-notched characteristics, Electron Lett 44(2008), 1387-1388.
10. R. Gayathri, T.U. Jisney, D.D. Krishna, M. Gopikrishna, and C.K. Aanandan, Band-notched inverted-cone monopole antenna for compact UWB systems, Electron Lett 44(2008), 1170-1171.
11. Amarveer Singh, Ekambir Sidhu ,Novel MicroStrip Patch Antenna Design for Bluetooth, IMT, WLAN and WiMAX Applications American Journal of Engineering Research(2014).
12. Mohammad Ojaroudi, Changiz Ghobadi, and Javad Nourinia “Small Square Monopole Antenna With Inverted T-Shaped Notch in the Ground Plane for UWB Application” IEEE ANTENNAS AND WIRELESS PROPAGATION LETTERS, VOL. 8, 2009.