

A REVIEW OF ECG MONITORING SYSTEM

¹Shweta m.boricha, ²himanshu Patel, ³hitesh Patel, ⁴Hardik Patel
¹PG student, ²Assistant Professor, ³Assistant Professor, ⁴CEO of company
¹Electronics and communication engineering,
¹Charotar University Of Science and Technology, Changa, India

Abstract: Day by day ECG monitoring system different technologies and methodology for acquisition of data from various modules are improving very fast. Furthermore we need ECG signal in real time aspects so that what type of processing and filtering unit is required and how much preferable it is that all things are comes into low cost and better quality performance. In hospital doctors have large ECG machine which provides perfect reading but patient cannot move during collecting data. . In recent years technology is diverted on wireless area network. Now small size of ECG machine available in market which is very cost effective but patient can move along with ECG machine and more over transmit data to doctor over more distance. ECG terminal may use 24 hours continuous monitoring in home or healthcare. The main thing about this ECG monitoring system can give the best result and comfort while taking heart reading of patient.

Index Terms - ECG monitoring system, Wireless standards, Channels, leads.

I. INTRODUCTION

ECG monitoring system has several advantages when it connected with wireless area network. Combination of embedded and wireless system is more affordable when we are talking about movement during taking ECG signals from patient's body. This is easier for patients who are suffering from heart problem and post recovery from any of the places. Heart beat monitoring for long distance without limitations of area that is cover by this system. Hospital and medical resources are really uneven distributed in our country. Limited number of hospital in rural area and number of people is in huge amount who suffers from heart disease and some of them dead

Because they don't have treatment or precautions at the time when it requires so that this system helps those people to use communication with their doctor what they have to do for pre-treatment. This paper provides you low cost, low power consumption and large facility for hardware and software. To meet requirement of ECG signal which have speed 500SPS or more than that and also multiple channels or multiple leads are require for better quality of the signal. Now ECG signal is available in single channel and multiple channels. Single channel or three channels have moderated output waveform where 12 leads and 10 electrodes have perfect output signal and more satisfied results but carryout more than five electrodes are somewhat not comfortable for patient so that monitoring purpose most of the wireless ECG have three channel or five channel system. There is standard 12 lead which is derived by 10 electrodes fig 1 show 10 electrodes placement.

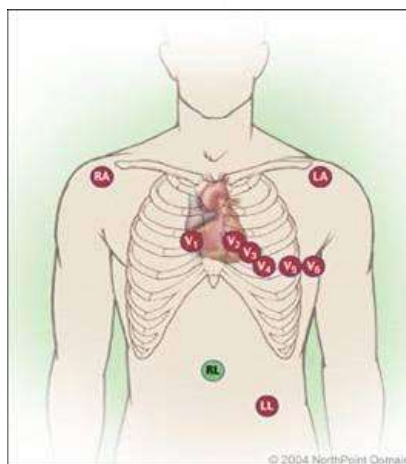

Fig 1: Twelve electrodes placement

This electrode defines leads which provide to the ECG module and amplifiers for getting output from channels. Standard 12 leads description is below. In fig 2 shows standard three leads which is derived by three main electrodes RA, LA and LL.

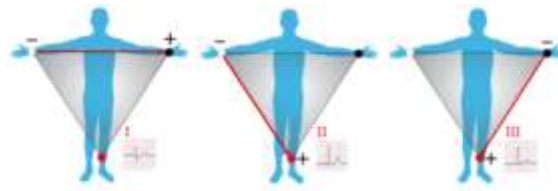

Fig.2 standard leads

Equation for this three leads are

$$1) \text{ Lead I} = \text{RA} - \text{LA} \quad (1)$$

$$2) \text{ Lead II} = \text{LL} - \text{RA} \quad (2)$$

$$3) \text{ Lead III} = \text{LL} - \text{LA} \quad (3)$$

Fig 3 show augmented leads which are derived by standard leads and electrodes.

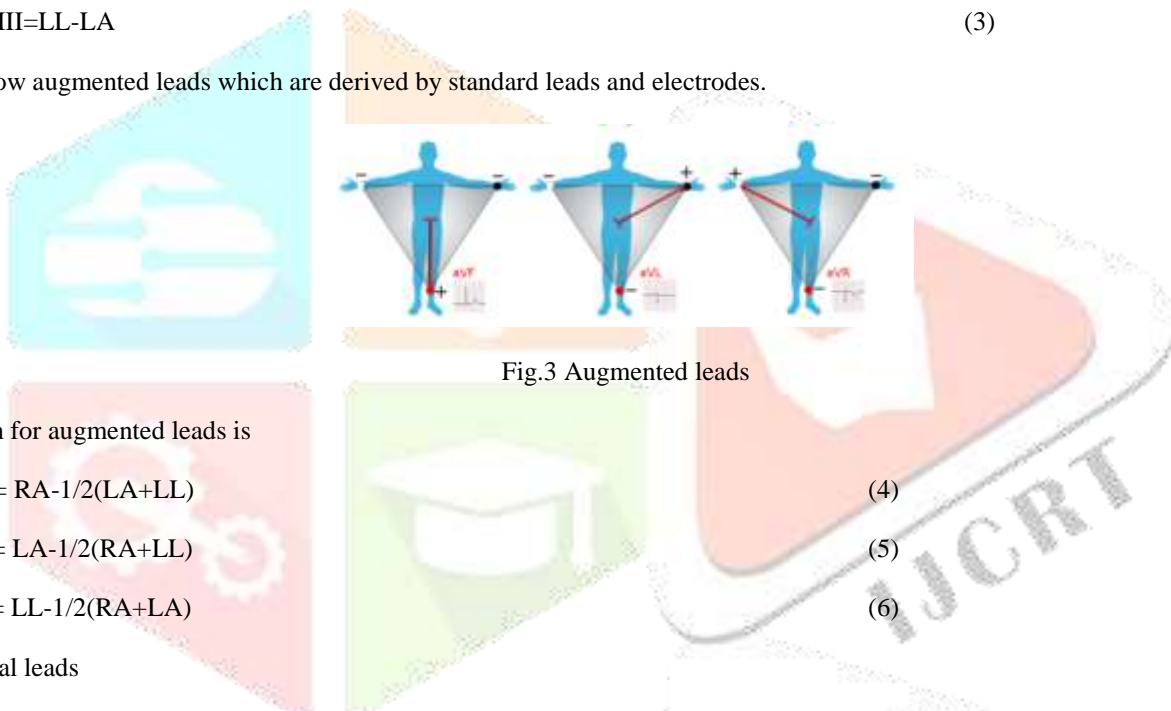

Fig.3 Augmented leads

Equation for augmented leads is

$$1) aVR = \text{RA} - 1/2(\text{LA} + \text{LL}) \quad (4)$$

$$2) aVL = \text{LA} - 1/2(\text{RA} + \text{LL}) \quad (5)$$

$$3) aVF = \text{LL} - 1/2(\text{RA} + \text{LA}) \quad (6)$$

Precordial leads

This leads are on horizontal plane and different from six leads. This electrode for precordial leads are v1, v2, v3, v4, v5 and v6 are behaving as positive terminal of amplifier and negative is WCT.

II. REVIEW OF WORK

Wireless ECG monitoring system is having problem with connection of electrodes with body which is sticky to patients body and that need hydrogel on electrodes there is another problem with noise when data is converted to analog to digital format this conversion is also have some noisy data. To remove this noise some extra circuit and filter are needed. Some solution of problem due to electrodes and conversion is mentioned in this paper.

III. METHODOLOGY

A new concept of wireless electrode is used by R.Fensil. Electrodes are stick on the patient body using hydrogel. This electrodes which is create one lead connected to the transmitter and several Battery powers which allows approximately five hour continuous transfer signal and this signals collect by PDA (personal digital assistant) which connected with HHD (hand held device) using RS232 which shows in figure 4. this product operated at 434.32MHz carrier frequency for Nordic nRf401 for processing and it will have 0.5 - Hz High pass filter and 150 Hz Low pass filter with differential gain of 250. friensen conclude in their own signal comparison that

nine QRS detection algorithms applied digital filter in all of them notch filter is better[1]. At the data collection time patient have a small device which transmit data on GPRS and received at clinical station. HHD has part of analyze the data and recorded for some amount of time. Clinical station has to do analysis data and if any unnecessary waves are shown in output staff can instruct that patient at precaution level. System configuration is Microsoft software of 2003 for PDA and Fujitsu-Siemens used in LOOX 700.

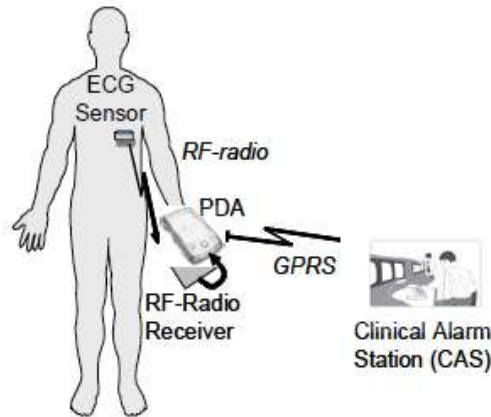

Fig.4 Wireless ECG device with clinical alarm

In 2007 H. Fariborzi, M. Moghavvemi, S. Mehrkanoon publish a paper and he denoted low power microcontroller based ECG machine which have amplifier for more cancellation of noise from ECG signal not concentrating on more than CMRR. Using MSP430F1612 which have 16 bit low power RISC architecture for processing. Transceiver have range of 100m which achieved by inverted-F micro-strip antenna on PCB.[2]

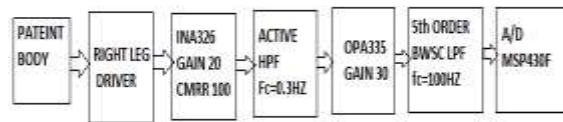

Fig.5 signal acquisition block

SPI protocol is used at the MCU level for data collection from electrodes and store in to memory. It's also referred Friesen's algorithm of nine QRS detection but some modification is done by H. Fariborzi, M. Moghavvemi, S. Mehrkanoon. He calculated each slope of ECG signal and then verify onset slope threshold values using max slope.[2]

In 2009 Jing Liang ,Yinqin Wu done wireless ECG monitoring system using OMAP. There is two part of this system where filtering and processing takes place. Now x86 architecture is expensive solution for the board of PC104 which is higher power consumption are occurred. FPGA is the solution for low power consumption but x86 architecture is not suitable for this board so that OMAP is used for this system. OMAP is containing two boards ARM and DSP where ARM is used for controlling and DSP is known for processing. Here ECG signals are takes from electrodes and gives it to A/D converter and gives to OMAP. For software point of view two methods are there one is DSP/BIOS which is provided by Texas Instruments and second one is DSP gateway which is better option for LINUX user. Output of A/D converter is gives to the OMPA which have some noisy results which contain 50 Hz frequency. 8 to 16 bit resolution is provide by A/D converter up to 1KHz sampling rate. Using SPI protocol this output gives to DSP TMS320C55x that use LADT (linear approximation distance Thresholding) algorithm.[3] ARM (ARM926EJ-S) containing Wi-Fi, ZigBee and Bluetooth. Around all standards using WI FI is better option for long distance. Wireless transmission of data packets are control by LINUX IPC mechanism and remote client synchronization. Data packets are stay in buffer until remote client gives acknowledgment that data is arrived with out and data loss and encryption occurs.[3]

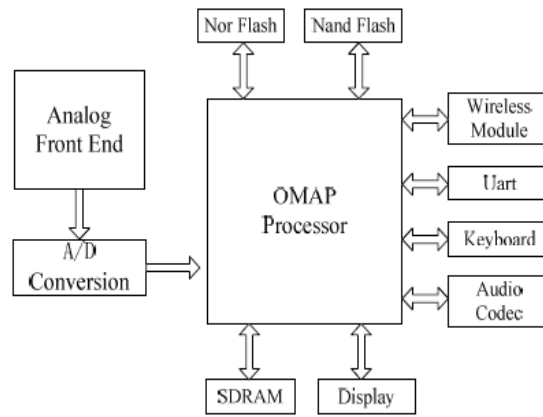

Fig.6 architecture of system

In 2012 Bin Yu and Lisheng Xu , Yongxu Li is concentrate on low power consumption in ECG monitoring system.[4] Medical instruments having problem with high power consumption modules are used but the wireless system is being heavy with high power battery. Bluetooth low energy module is very low power consumption which can use a coin cell for few months or a year basis. So they have used electrodes for data collect from body and ADC module used by 8051 which processed data analog to digital and then it connects to Bluetooth low energy module. When electrodes are not connected with Bluetooth low energy that time module is in sleep mode so power is less. ECG system in on state Bluetooth low energy (v4.0) is connect with smart phone and this BLE have different profile for that GATT profile for advertising and GAP profile for connection and bonding purpose. Mobile having ECG analyzer by E.P limited and this application is used x code and c language. It having three main part first was data acquisition second was data processing and third was mobile application which shown in below figure.[4]

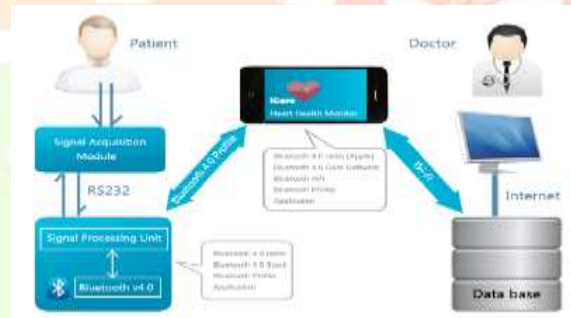

Fig.6 Block diagram of the wireless monitoring

IV. RESULTS AND DISCUSSION

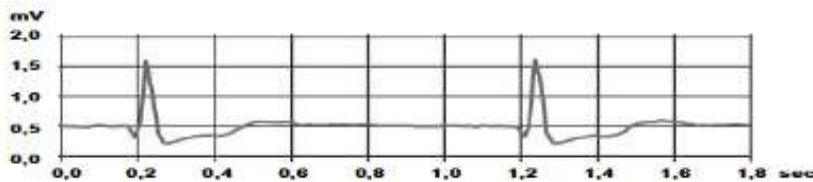

Fig. 7 ECG signal

Figure 7 shows the result of R.Fensil wireless ECG machine with provide one lead output. But in 2007 which methods and module describe above is gives three leads output and gives better result than fig 7 and specialist of cardiac system is says it is perfect at P ,QRS complex and T wave as 81.5%, 98.1% and 85.2% respectively.[1] This is all analysis done in MATLAB. This system is affected when power line loss are take place and P wave is absent or T wave is in elevation case that time system is not gives output correctly. This can be overcome by negative false convert into positive false.

In OMAP based wireless ECG gives wireless data which shows below graph figure 8 shows noise data without filtering and figure 9 shows data after filtering this data is real time plot on MATLAB with using LADT algorithm.[2]

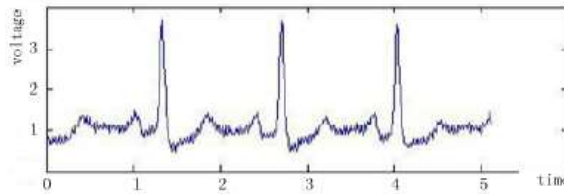

Fig.8 without filtering

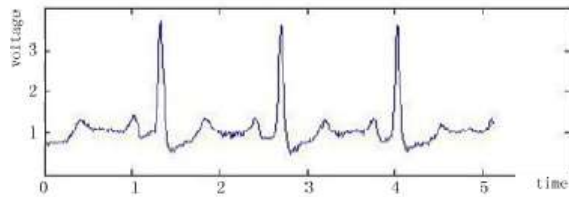

Fig. 9 with filtering

Figure 10 shows result of remote client which get this data on mobile application.

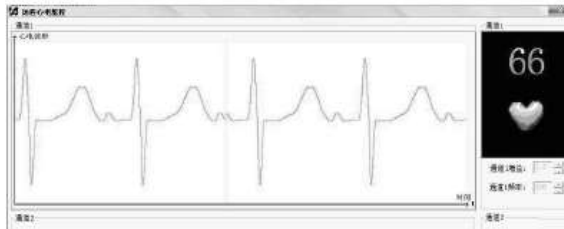

Fig.10 output on software

BLE based wireless system result shown below which is having two electrode and single lead output on mobile phone without any noise. This is more preferable when you are having single lead in your system.



Fig.11 output on iphone

V. CONCLUSION

From this paper there is different ECG monitoring system for wireless data reception. Some of them electrodes having continuous transmission recording of heart event tachycardiac, Bradycardiac and other syndromes of heart can be detect by this systems. Some of them occupying low power consumption, better quality of signal, less area requirement and low cost. Till now three lead or five lead ECG monitoring system is made wireless. twelve lead of ECG is more preferable when come to analyse and detect symptoms of heart disease more perfect and till now it has been wired ECG system because of more electrodes are occupy in system.

REFERENCES

- [1] R. Fensli; E. Gunnarson; O. Hejlesen," A wireless ECG system for continuous event recording and communication to a clinical alarm station",The 26th Annual International Conference of the IEEE Engineering in Medicine and Biology Society The 26th Annual International Conference of the IEEE Engineering in Medicine and Biology Society, USA,Vol. 1, pp.2208-2211, 2004.
- [2] H. Fariborzi; M. Moghavvemi; S. Mehrkanoon," *Design of a Low power Microcontroller based Wireless ECG Monitoring System*",2007 5th Student Conference on Research and Development, Malaysia, pp.1-4,2007
- [3] Jing Liang ,Yinqin Wu, "Wireless ECG Monitoring System Based on OMAP",2009 International Conference on Computational Science and Engineering, Canada, vol:2 , pp.1002 - 1006,2009
- [4] Bin Yu, Lisheng Xu, Yongxu Li,"*Bluetooth Low Energy (BLE) based mobile electrocardiogram monitoring system*",2012 IEEE International Conference on Information and Automation, china, pp.763 – 767, 2012
- [5] D.Simunic, S.Tomac,I.Vrdoljak,"*Wireless ECG monitoring system*",2009 1st International Conference on Wireless Communication,Vehicular Technology, Information Theory and Aerospace & Electronics Systems Technology,Denmark,pp.73-76,2009
- [6] O.Apostu, B.Hagiu, S.Paşca,"*Wireless ECG monitoring and alarm system using ZigBee*" 2011 7th international symposium on advanced topics in electrical engineering (ATEE),pp.1-4,2011
- [7] K.Ernest, C.Lamei, S.Mohamed, M.Shakshuk, I.Badreldin, I.ElBabli, "A ZigBee-based tele cardiology system for remote healthcare service delivery", 2011 1st Middle East Conference on Biomedical Engineering,pp.442-445,2011
- [8] V.Wahane, P.Ingole,"*An Android based wireless ECG monitoring system for cardiac arrhythmia*", 2016 IEEE Healthcare Innovation Point-Of-Care Technologies Conference (HI-POCT), Maxico,pp.183 - 187,2016
- [9] Z. M. Amin, N. A Razak, M. F Misnan, S. Ilias, Z. Mohamed, R.Udin,"*Multiagent wireless ECG monitoring system(MAWEMS)*",2015 Innovation & Commercialization of Medical Electronic Technology Conference (ICMET), Malaysia,pp.26 – 29,2015
- [10] Y.Wang, R.Wunderlich, S.Heinen,"*Design and evaluation of a novel wireless reconstructed 3 lead ECG monitoring system*", 2013 IEEE Biomedical Circuits and Systems Conference (BioCAS), Netherlands,pp.362-365,2013
- [11] Cheng-Pin Wang, Shuenn-Yuh Lee, Wei-Chih Lai," *An RFID tag system-on-chip with wireless ECG monitoring for intelligent healthcare systems*", 2013 35th Annual International Conference of the IEEE Engineering in Medicine and Biology Society (EMBC),Japan, pp.5489 – 5492,2013
- [12] G.K. Andurkar, Ms. Jayashri Mohurley, Vishakha Borkar, "Review Paper on Wireless Wearable Sensor System for Cardiac Activity Monitoring" "Review Paper on Wireless Wearable Sensor System for Cardiac Activity Monitoring", International Journal of Advanced Research in Computer and Communication Engineering, Vol. 6, Issue 3, pp.152-158,2017
- [13] J. Becker, D. Gebauer, L. Maier-Hein, M. Schwaibold, J. Schöchlin, and A. Bolz, "The Wireless monitoring of Vital Parameters: A design study.," Biomed Tech (Berl), vol. 47, pp.851-3, 2002.
- [14] K. Y. Kong, C. Y. Ng, and K. Ong, "Web-Based Monitoring of Real-Time ECG Data,"Computers in Cardiology, vol. 27, pp. 189-192, 2000.
- [15] D. Krahn, G. J. Klein, R. Yee, and C. Norris, "Final Results From a Pilot Study With an Implantable Loop Recorder to Determine the Etiology of Syncope in Patients With Negative Noninvasive and Invasive Testing," The American Journal of Cardiology, vol. 82, pp. 117-119, 1998.
- [16] R. Fensli, E. Gunnarson, and T. Gundersen, "Design Requirements for Long-Time ECG recordings in a Tele-Home-Care Situation, A Survey Study," Scandinavian Conference in Health Informatics 2004, 2004, Arendal, Norway, 2004; pp14-18.
- [17] A.I. Hernandez, F. Mora, M. Villegas, G Passariello, G Carrault, "Real-time ECG transmission via Internet for nonclinical applications", IEEE Transactions on Information Technology in Biomedicine, vol. 5, no. 3, 2001, pp.253 –257.