

SUHVDC Compensator based Transient Control HVDC Transmission Systems for Offshore Wind Power Plants

M. Sangeetha, R. Arivoli, B. Karthikeyan

Assistant Professor, Department of EEE, Imayam College of Engineering, Kannanur, Thuraiyur, India.

Associate Professor, Department of EEE, Annamalai University, Annamalai Nagar, India.

Professor and Head, Department of EEE, Presidency University, Bangalore, India.

Abstract- Transient Adduct of offshore wind power plant in proposed system is carry out by unified high voltage direct current transmission (HVDC) compensation. This HVDC transmission system recovers the shortcoming of trend AC transmission network. The model of HVDC system is designed by the combination of shunt and series compensator. Under violating condition (transient) it ensures, fasts fault clearance, Direct current link voltage regulation and recover the frequency deviation. The control of HVDC is designed by methodology of synchronous reference frame technique (SRF) is not powerful to control the frequency variation. The above problems are rectified by later techniques of proportional integral (PI) controller and neural network controller. The design of system and transient responses for various condition are analyzed by Matlab/Simulink.

Key Words: Transient Adduct, Proportional integral controller, neural network, high voltage DC transmission.

1. INTRODUCTION

Wind energy conversion system is the non polluting renewable energy resource to overcome the world's needing energy demand. Normally permanent magnet synchronous generator (PMSG) or doubly fed induction generator (DFIG) are used as turbine in WECS [1]. PMSG based system is mostly used in WPP for its higher efficiency and it doesn't require any gearbox [2]. The back to back voltage source converter (VSC) is used to connect the WPP to grid system. It ensures the system reliability and cost effectiveness. The transmission of offshore wind plant is achieved by the high voltage direct current (HVDC) transmission system in here high power electronic technology is used. It is widely used in electric power system to transmit the large amount of power for long distance, asynchronous interconnection, power flow control. Thus the VSC-HVDC system issue independent control of active and reactive power flow in a transmission system. The main consideration while the bulk power transmission of HVDC system is grid fault disturbances which lead a stability problem.

This problem of transient is avoid by the series and shunt compensator denoted as Unified based HVDC system (UHVDC) with augmented the fault ride through (FRT) capability. The proposed system has the series and shunt compensation devices to provide symmetrical and asymmetrical fault condition, smooth power transfer, regulated dc link voltage, transient management and hence improved reliability. To achieve it control technique is necessary. The performance of this entire system depends upon the operation of inverter switches and hence it must be regulated [3]. The proposed system assures to reduce the transients, dc link regulation. This proposed large scale WPP with UHVDC system is designed and the results of different case studies are analyzed with MATLAB/ SIMULINK environment.

2. SYSTEM CONFIGURATION

The offshore WPP contains the PMSG based number of wind turbines connected either in series and shunt configuration. The power transfer between offshore WPP and onshore grid is achieved through high voltage direct current (HVDC) transmission system. The proposed configuration has voltage source converter (VSC) based compensator units. It employs modern semiconductor switches such as IGBT/GTO which is compact in size compared to classic thyristor valve based converters. It is based on self-commutated pulse width modulation (PWM) technology. Also IGBT has the ability to turn ON and OFF with much higher frequency and does not requires any reactive power support [4].

Hence this enables easy in changing the reactive power flow within the system. The different configurations of VSC-HVDC system is monopole, bipole, back-to-back or asymmetric, multi terminal [3]. The figure 1 shows the system configuration of proposed multi-terminal VSC-HVDC system for wind power plant. The proposed configuration is called as UHVDC system which provides both series and shunt compensation. The WPP of proposed system has offshore and onshore VSC station. The Offshore station accommodate one converter and the onshore station contains two independent converters namely series and shunt converters. The onshore VSC station is connected with the electrical grid system through two shunt connected transformers (T_{r3} and T_m) and this assures power transfer between WPP and grid system.

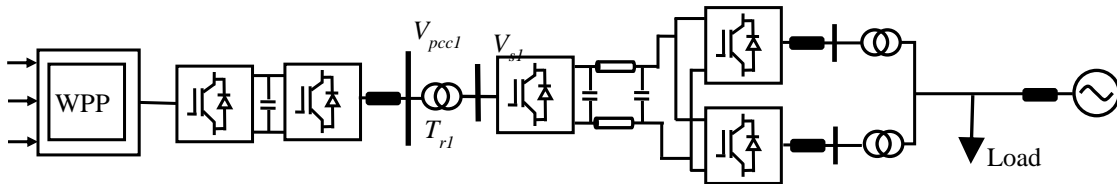

fig 1 configuration of uhvdc with wpp system

The converters of both onshore and offshore station should be capable to handle the power generated by the wind farms and the power is delivered to the electrical grid through HVDC system. The advantage of proposed configuration is to give series and shunt compensation to the system during any grid fault without requiring any additional compensation device. This helps to reduce the additional converter costs and hence the proposed system is a cost effective one.

If the fault is occurred in any one of the voltage source, the series transformer delivers the series voltage to prevent the entire system from the severe grid fault. Simultaneously, the proposed system provides voltage and current compensation by series and shunt VSC of onshore station. The changeover from one operation into another during both steady state and transient condition is achieved by the proper handling of converter switches in UHVDC system [5].

Existing Conventional SRF Scheme

The performance of UHVDC is examined using conventional SRF control scheme. The investigations are carried out under different case studies such as low frequency transient and high frequency transient. The DC link voltage for low and high frequency transients is controlled at rated value for case 1 only and remaining cases DC link voltage is failed to maintain at rated value. This problem is mainly due to the control scheme is depends on supply frequency. To overcome the above problems the PI and NN are introduced fatherly.

3 Control Structure of Shunt Compensator

The control scheme of onshore and offshore shunt UHVDC system is shown in figure 2. From the figure, it is observed that there will be four parts of the control scheme of shunt converter of UHVDC station. The first part is used to extract the negative sequence component and the second part performs computation of positive sequence component. The third part deals with transient detection and management scheme.

The transient detection and management is successfully achieved by PI controller. Here the reference and actual DC link voltage is compared and the error signal is given to PI controller unit. PI controller has system parameters such as, Kp and Ki. The function of PI controller is totally depends on this system parameter values chosen. Therefore it is very important to choose the value to get actual DC link voltage tracks very close to that of its reference value.

$$\begin{bmatrix} i_{sa}^* \\ i_{sb}^* \\ i_{sc}^* \end{bmatrix} = \begin{pmatrix} \sin \theta & \cos \theta & \frac{1}{2} \\ \sin(\theta - \frac{2\pi}{3}) & \cos(\theta - \frac{2\pi}{3}) & \frac{1}{2} \\ \sin(\theta + \frac{2\pi}{3}) & \cos(\theta + \frac{2\pi}{3}) & \frac{1}{2} \end{pmatrix} \begin{bmatrix} i_{Ld} \\ i_{Lq} \\ i_{L0} \end{bmatrix} \tag{1}$$

The performance of this SRF control is based on the result obtained from this PI controller. The regulation of DC link voltage delivers smooth and fast power transfer within the system and hence improved transient is also achieved meanwhile. The final part is pulse generation part for shunt VSC. The transformation is done from three phase (abc to dq0) to find out the positive and negative sequence (dq0) components.

The dq0 components are extracted directly from the voltage and current of the offshore station. The shunt VSC performs the current compensation and hence it deals with transformation of distorted three phase current to dq0 quantities. Finally the transformed reference current is given to pulse generation block to produce the required firing pulse of converter station [7, 8]. The general equation for three phase current in stationary axis (abc) is transformed into two phase rotating co- ordinates (dq0) is given below,

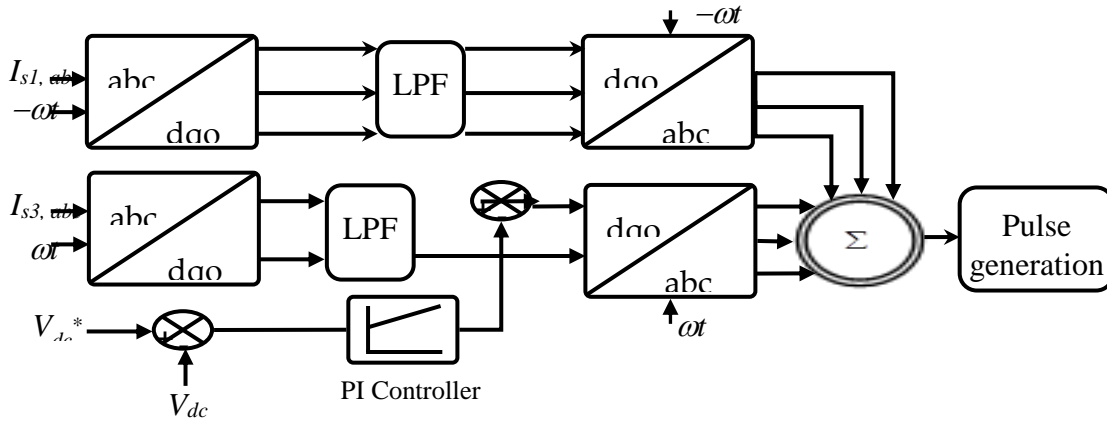

fig 2 control technique for shunt compensator using pi controller

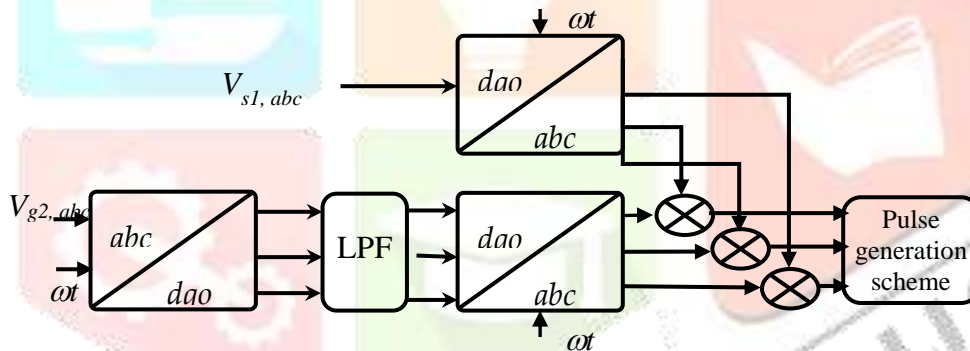

fig 3 control technique diagram for series compensator

$$\begin{bmatrix} i_{Ld} \\ i_{Lq} \\ i_{Lo} \end{bmatrix} = \begin{pmatrix} \cos \theta & \cos(\theta - \frac{2\pi}{3}) & \cos(\theta + \frac{2\pi}{3}) \\ \sin \theta & \sin(\theta - \frac{2\pi}{3}) & \sin(\theta + \frac{2\pi}{3}) \\ \frac{1}{2} & \frac{1}{2} & \frac{1}{2} \end{pmatrix} \begin{bmatrix} i_{sa}^* \\ i_{sb}^* \\ i_{sc}^* \end{bmatrix} \tag{2}$$

Finally, the desired reference current is calculated by taking inverse transformation of (dq0) axis into three phase (abc) rotating frame axis and is derived by the following eqn (2).

4. Control Structure of Series Compensator

The control strategy for series onshore UHVDC diagram is shown in figure 4. The series converter provides the voltage and transient compensation. When the fault is created at any one of the voltage source (V_{g1} or V_{g2}) the power transfer within the system is gets affected. To protect the WPP turbines based HVDC system from fault disturbances and severe transient, a series converter provides series voltage V_{ser} . This voltage is injected into the system at PCC through series transformer [9].

When a fault is created at V_{s2} side, the compensation is done at shunt side V_{s3} . The total power delivered at series UHVDC system is given by the equation.

$$P_{tot,ser} = P_{ser} + P_{cos} \cos(2\omega t) + P_{sin} \sin(2\omega t) \quad (3)$$

The total active power $P_{tot,ser}$ is divided into three parts, series average power, cosine power and sine power and is cancelled and equated to zero by the generation of reference negative sequence component of series voltage and then this two phase voltage is again transformed into three phase abc rotating frame axis voltage by taking inverse transformation [10]. Then finally applied to switching pulse generation unit to produce pulses for series compensator.

5. Analysis on DC Link Voltage Using PI Controller

The DC link voltage for low and high frequency transients are analyzed using the PI scheme with constant frequency method which is shown in figure 4 and 5. The DC link voltage is controlled at rated value up to 4 cases and remaining cases DC link voltage is failed to maintain at rated value. This problem is mainly due to the PI control scheme depends system parameters.

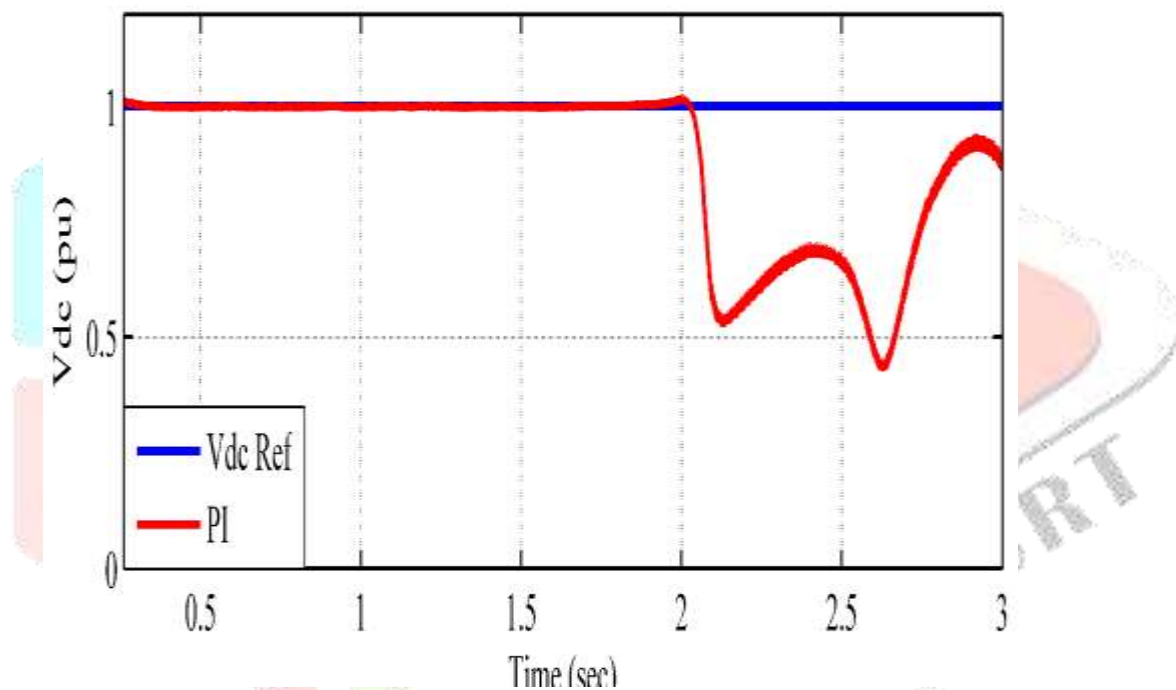

fig 4 : dc link voltage control using pi, at low frequency transient

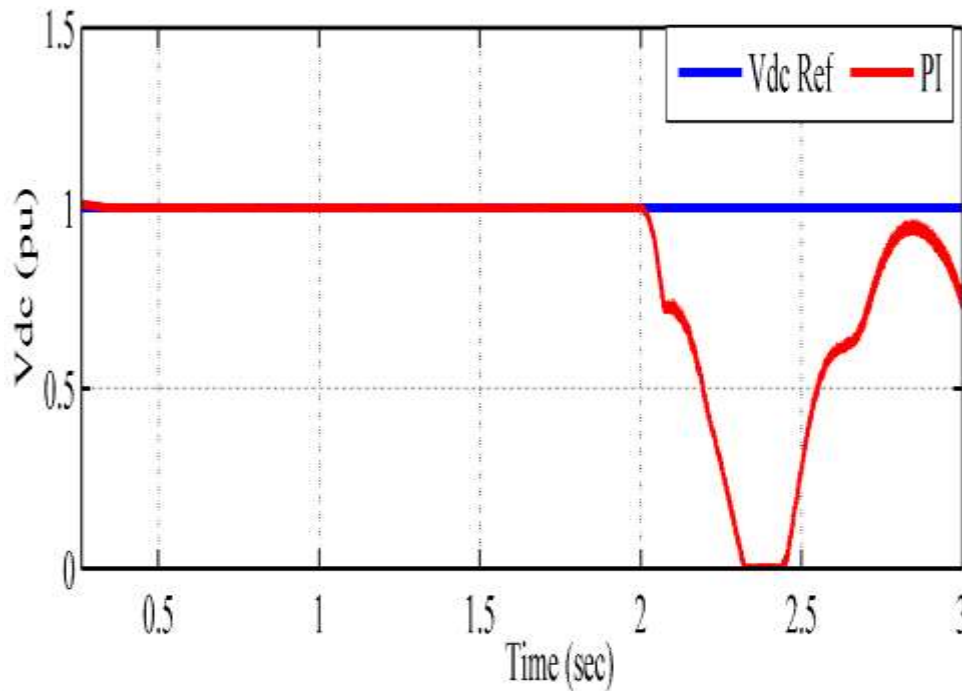

fig 5. dc link voltage control using pi, at high frequency transient

6. Analysis on DC Link Voltage Using NN Controller

The DC link voltage for low and high frequency transients are shown in figure 6 and 7. using the NN scheme. The DC link voltage is controlled at rated value for all cases. This can be achieved by NN control is inherent of system parameter.

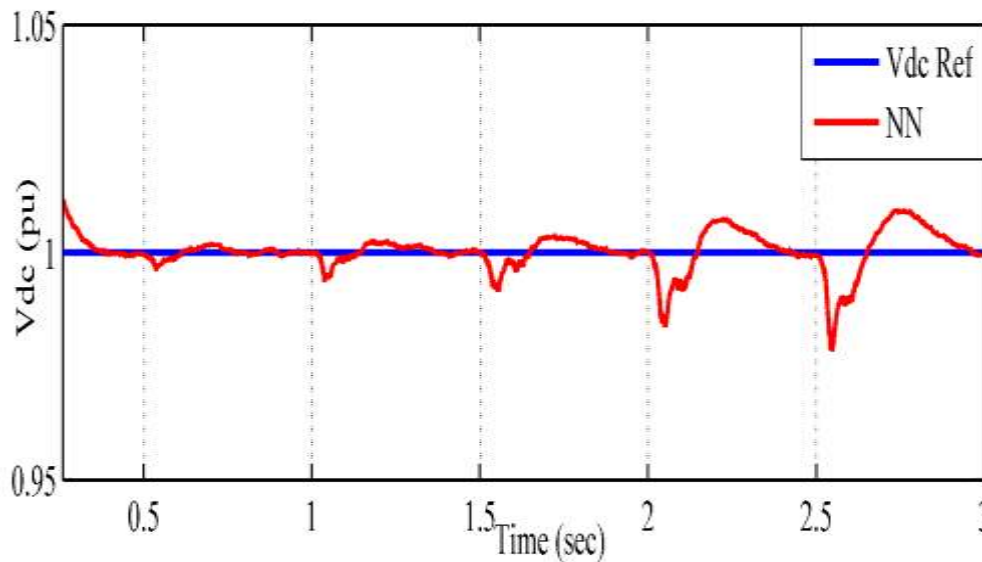

fig- 6 dc link voltage control using nn controller, at low frequency transient

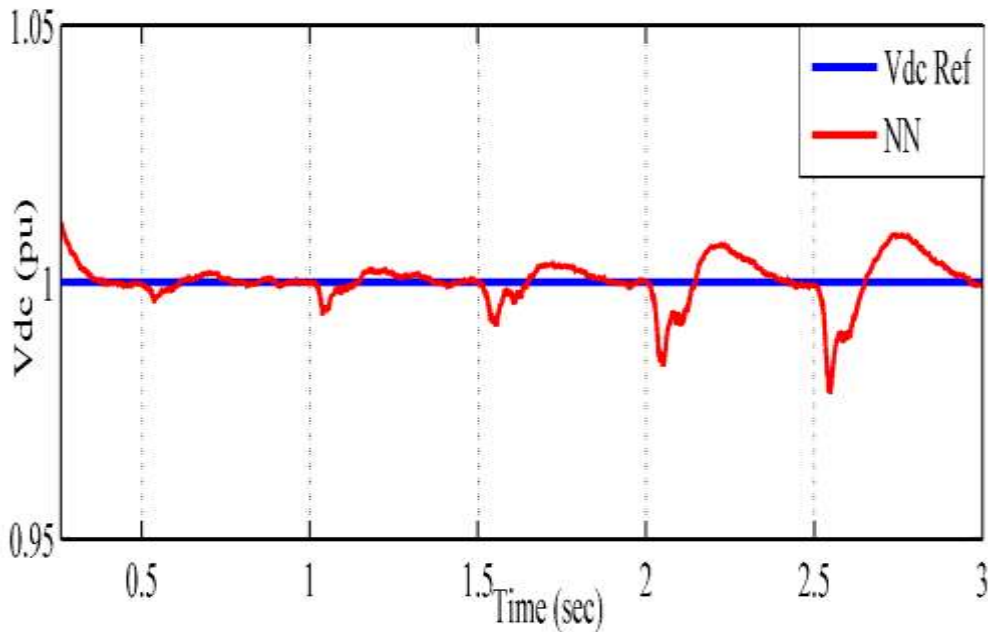

fig 7. dc link voltage control using nn controller, at high frequency transient

7. Simulation Analysis On PI and NN system

The simulation on proposed configuration applied with IEEE 9-bus system. The performance and compensation capability of proposed test system is analyzed with control SRF, PI-SRF and NN-SRF control schemes and the obtained test results are plotted. The analysis are conducted under low and high frequency transient conditions of varying load.

7.1 Analysis on Frequency Estimation Using PI and NN Controller

The simulation responses for estimation of frequency using PI and NN controller based SRF under low and high frequency transients are shown in Fig 8 and Fig.9 respectively. These analysis are take out for load varying condition.

Form the obtained results, PI- SRF delivers successful estimation of supply frequency up to 2 sec. After 2 sec, variable frequency estimation by PI-SRF method failed to tracks the supply frequency. This issue is mainly due to analytical method highly depends on system parameter. The proposed NN based SRF is provides excellent compensation under all conditions. For NN based SRF, the supply frequency is successfully estimated under low and high frequency transient states. Hence the proposed control scheme is suitable for practical applications.

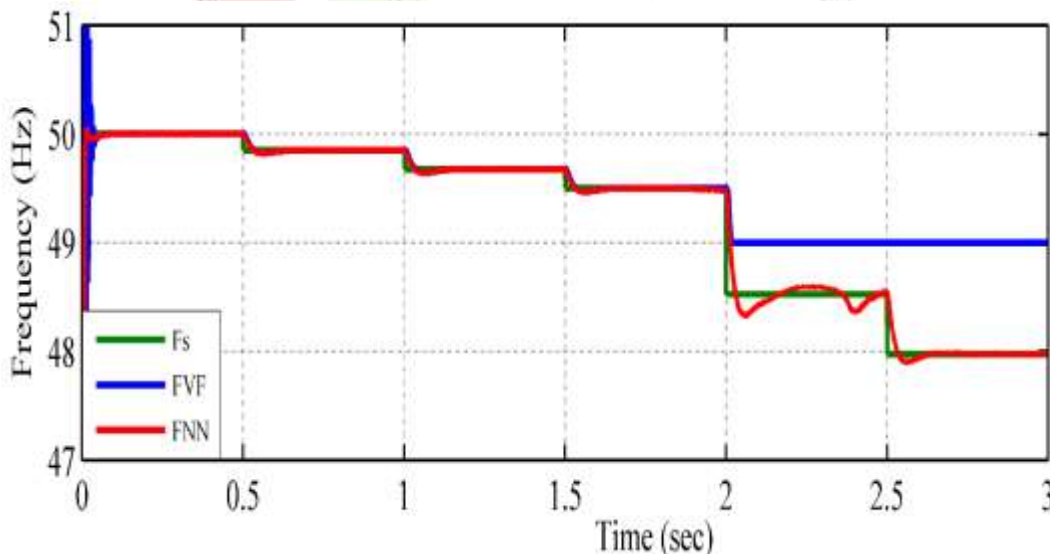

fig 8 frequency estimation using pi and nn controller based srf at low frequency transient

7.2 Analysis on DC Link Voltage Using PI and NN Controller

For better compensation of transients and smooth power transfer using UHVDC is made by optimal regulation of dc link voltage. Per unit (pu) simulation responses for dc link voltage control using conventional SRF, PI-SRF and NN-SRF control technique under low and high frequency transients are shown in Fig.10 and Fig. 11 respectively and the results comparison are made in table 1 and table 2. Form the obtained results, using conventional SRF, DC link voltage is controlled until 0.5 sec only and it failed for remaining cases. This problem is mainly due to constant frequency used in the Clark park transformation. For PI based SRF method, the DC link is controlled successfully up to 2 sec. After 2 sec, PI-SRF method failed to estimate the supply frequency.

This issue is mainly due to supply frequency is failed to estimate by this method. For NN based SRF, the DC link voltage is successfully controlled under all conditions of load variation. Hence NN SRF based UHVDC has ability to compensate transients and effective power transfer. The simulation waveform of DC link voltage regulation at voltage disturbance is plotted in Fig. 11.

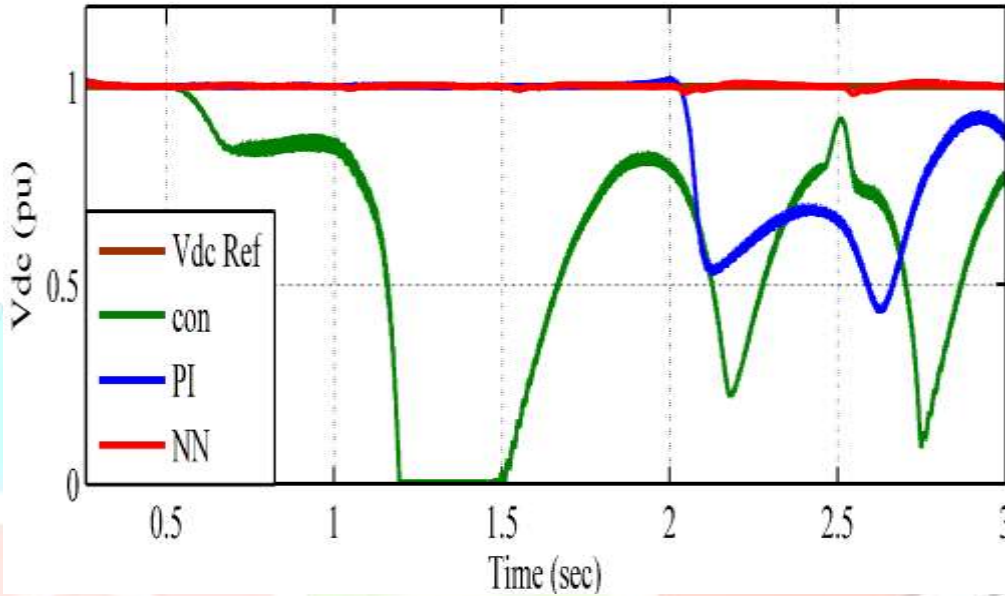

fig 10.dc link voltage control using conventional, variable frequency and nn at low frequency transient

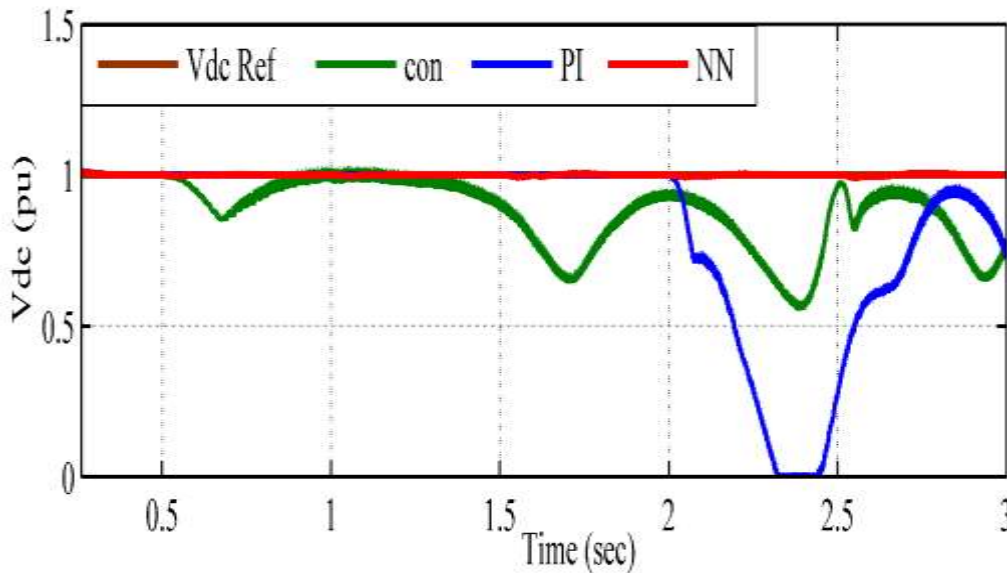

fig 11. dc link voltage control using conventional, variable frequency and nn at high frequency transient

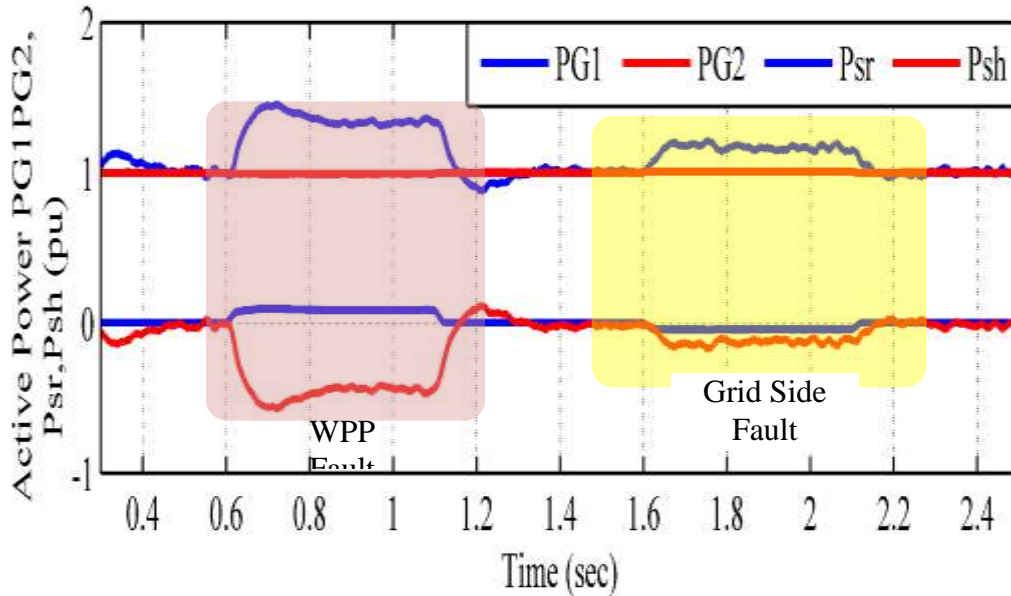

fig 12 real power transfer using pi controllers

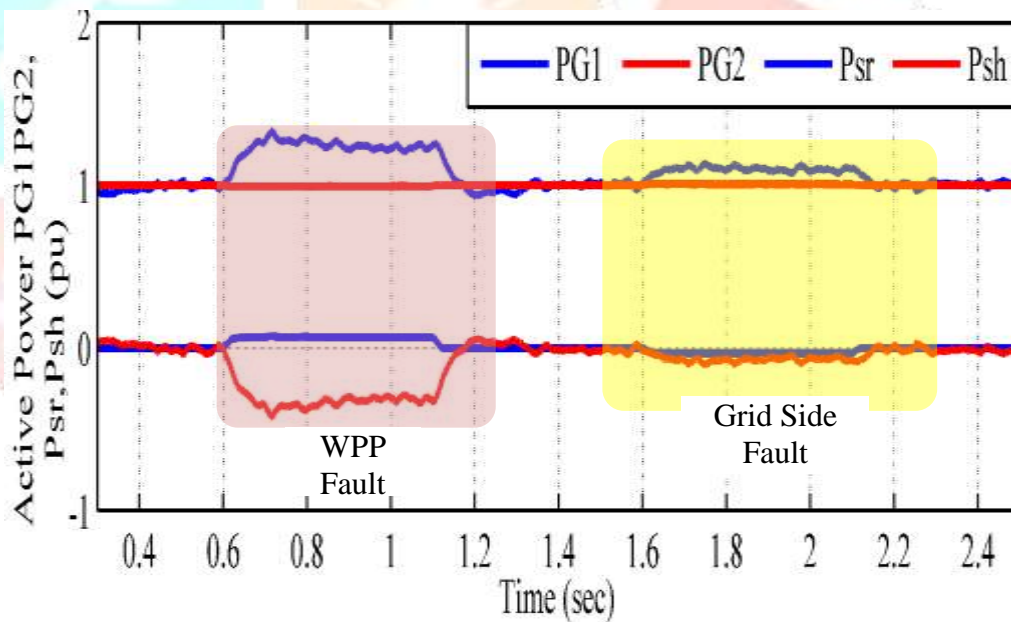

fig 13 real power transfer using nn controllers

7.3 Analysis on Real Power Transfer Using PI and NN Controller

The simulation analysis on real power transfer using conventional, PI-SRF and NN-SRF are plotted. Here investigates on power transfer between offshore WPP and onshore power grid. The source power i.e., grid 1 real power (P_s), load power i.e., grid 2 real power (P_L), series compensator real power (P_{sr}) and shunt compensator real power (P_{sh}). The simulation responses for real power transfer under fault created at wind power plant and grid side fault using PI and NN controller is shown in Fig.12 and Fig.13.

The simulation responses of three phase grid 1 voltage, grid 2 Voltage and series voltages are shown in Fig. 14,15and 16 respectively. The table 1 which shows the Performance Comparison of PI and NN Control Schemes.From the tabulation it's clearly observed that operation condition of Dc link voltage at various condition ,NN controller gives better response when compared to other two techniques of PI and SRF .

The time taken for transient compensation in NN also less when compared to the PI. The table 2 shows the various system parameters used in wind power station for both on shore and off shore and also

Table 1. Performance Comparison of PI and NN Control

| OperationCondition | DC link Voltage Control | | | | Time taken forTransient Compensation (msec) | |
|------------------------|-------------------------|------|----------------------|-----|---|-----|
| | Peak Overshoot(%) | | Settling Time (msec) | | PI | NN |
| | PI | NN | PI | NN | | |
| Initial condition | 18.3 | 1.41 | 450 | 380 | 600 | 450 |
| WPP side disturbances | 11 | 5 | 160 | 100 | 250 | 100 |
| Grid Side Disturbances | 20.5 | 4 | 500 | 250 | 280 | 110 |

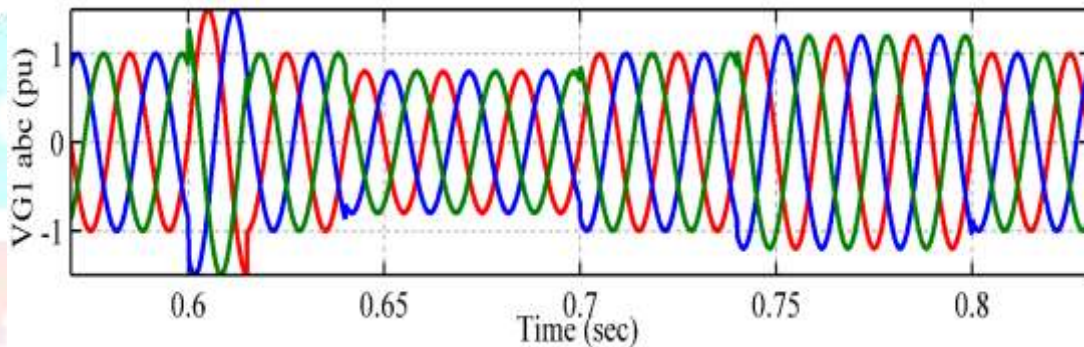

fig 14 simulation result for three phase grid 1 voltage

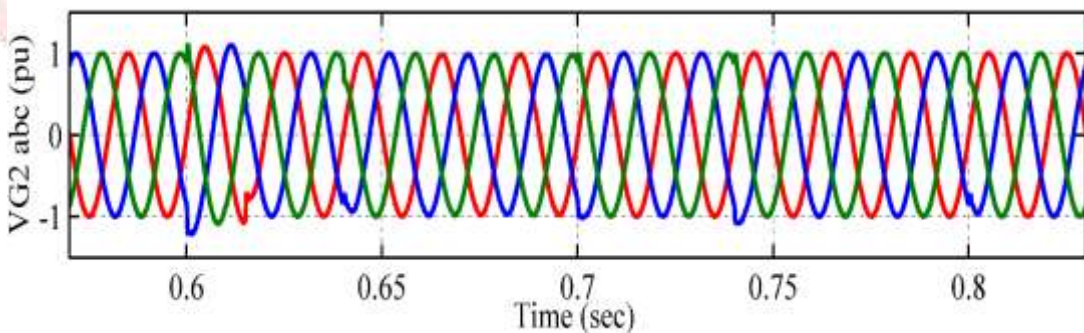

fig 15 simulation result for three phase grid 2 voltage

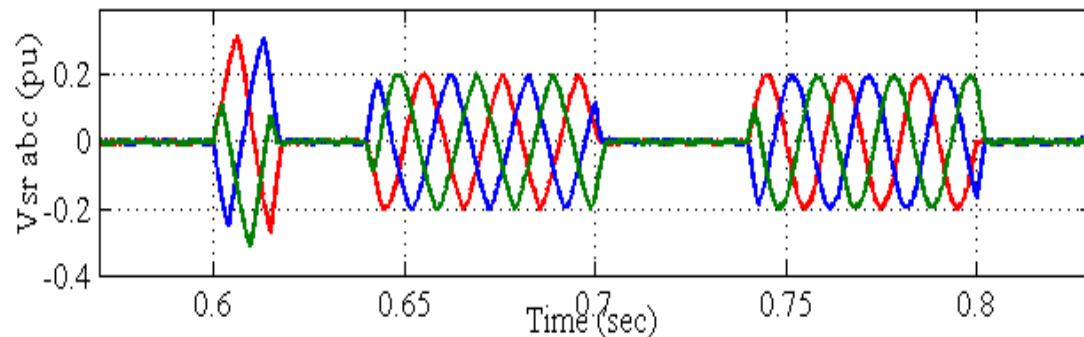

fig 16 simulation result for three phase series voltage

Table 2 System Parameter

| Electric Grids | | Offshore Station | |
|-------------------------------|--------------|-------------------------------|------------|
| Frequency | 50Hz | Rated Power | 250MVA |
| Grid voltage | 230KV | WPP Voltage | 33KV |
| X/R | 20 | Transformer Ratio | 33KV/230KV |
| Short circuit ratio | 30 | Leakage Reactance | 0.11pu |
| Leakage Reactance | 0.11pu | AC Filter L1 | 40mf |
| Transmission Line Impedance | 0.2pu | AC Filter C1 | 100uf |
| Onshore Station | | | |
| Series Compensator | | Shunt Compensator | |
| Rated Power | 125MVA | Rated Power | 125MVA |
| Transformer rating | 200MVA | Transformer rating | 200MVA |
| TRANSFORMER Leakage reactance | 0.06pu | TRANSFORMER Leakage reactance | 0.11pu |
| AC Filter 2 Series L2s | 20mh | AC Filter 2 Series L2s | 45mh |
| AC Filter 2 Series C2s | 100uF | AC Filter 2 Series C2s | 150uF |
| DC Link | | | |
| DC Link Voltage | 400KV | | |
| DC Capacitance | 1600uF | | |
| DC cable resistance | 0.004ohms/km | | |
| DC cable capacitances | 11.3uF/km | | |

CONCLUSION

The performance of UHVDC is inquired using commensurate PI and Neural Network control schemes for low and high frequency transients under different case studies. The performance of conventional scheme is found to be fine under rated frequency conditions whereas it failed under variable frequency conditions. This problem is mainly due to control scheme is depends on supply frequency. Using PI controller, the performance is regulated up to 4 cases but it failed under case 5 and 6. This is mainly due to frequency estimation depends on system parameter. This problem is solved by neural network controller. While using NN controller, the UHVDC is optimally regulated for six cases. Since NN base UHVDC has robust capability on compensation of transients and wide range of operating conditions and future UHVDC will develop for hybrid system and remote areas.

REFERENCES

- [1]. M. Sangeetha, R. Arivoli and B. Karthikeyan, "Neural Network Based UHVDC for Enhancement of Transient Compensation In Offshore Wind Power Plant," *Journal of Electrical Engineering* (ISSN: 1582-4594), Vol17(2), pp. 446-454.
- [2]. M. Sangeetha, R. Arivoli and B. Karthikeyan, "Improved Transient Management Scheme in UHVDC Based Offshore Wind Power Plant," *International Journal for Research in Applied Science & Engineering Technology (IJRASET)* (ISSN: 2321-9653), Vol 5(7), pp. 1379-1385.
- [3]. M. Sangeetha, R. Arivoli and B. Karthikeyan, "Neural Network Variable Frequency Scheme for Transient Management in Offshore Wind Power Plant Using UHVDC," *International Journal for Research and Development in Technology (IJRDT)*, (ISSN: 2349-3585).
- [4]. M. Sangeetha, R. Arivoli and B. Karthikeyan, "Improved Transient Compensation Using PI-SRF Control Scheme Based UHVDC For Offshore Wind Power Plant," *International Research Journal of Engineering and Technology (IRJET)*, (ISSN: 2395-0056). M. Sangeetha, R. Arivoli and B. Karthikeyan, "Control of Unified HVDC for Offshore Wind Power Plant," *International Journal for Scientific Research and Development (IJSRD)*, (ISSN: 2321-0613).
- [5]. Z. Chen, J. Guerrero, and F. Blaabjerg, "A review of the state of the art of power electronics for wind turbines," *IEEE Trans. Power Electron.*, vol. 24, no. 8, pp. 1859–1875, Aug. 2009.
- [6]. Ahmed Moawwad, Mohamad Shawky El Moursi and Weidong Xiao, "A Novel control strategy for VSC-HVDC connecting offshore wind power plant," *IEEE Trans. Sustain. Ener.*, vol. 5, no.3 pp. 1204–1212, 2014.
- [7]. P. Bresesti, W. L. Kling, R. L. Hendriks, and R. Vailati, "HVDC connection of offshore wind farms to the transmission system," *IEEE Trans. Energy Convers.*, vol. 22, no. 1, pp. 37–43, Mar. 2007.
- [8]. N. Flourentzou, V. Agelidis, and G. Demetriades, "VSC-based HVDC power transmission systems: An overview," *IEEE Trans. Power Electron*, vol. 24, no. 3, pp. 592–602, Mar. 2009.
- [9]. X. Chen, C. Zhao, and C. Cao, "Research on the fault characteristics of HVDC based on modular multilevel converter," in *Proc. IEEE Trans. Electr. Power Energy Conf.*, Oct. 3–5, 2011, pp. 91–96.
- [10]. S. Alepuz et al., "Control strategies based on symmetrical components for grid-connected converters under voltage dips," *IEEE Trans. Ind. Electron.*, vol. 56, no. 6, pp. 2162–2173, Jun. 2009.
- [11]. D. Ruiu, R. I. Bojoi, L. R. Limongi, and A. Tenconi, "New stationary frame control scheme for three-phase PWM rectifiers under unbalanced voltage dips conditions," *IEEE Trans. Ind. Appl.*, vol. 46, no. 1, pp. 268–277, Jan./Feb. 2010.
N. Flourentzou, V. G. Agelidis, and G. D. Demetriades, "VSC-based HVDC power transmission systems: An overview," *IEEE Trans. Power Electron.*, vol. 24, no. 3, pp. 592–602, Mar. 2009.
- [12]. M. Baradar and M. Ghandhari, "A multi-option unified power flow approach for hybrid AC/DC grids incorporating multi-terminal VSC HVDC," *IEEE Trans. Power Syst.*, vol. PP, no. 99, pp. 1–8.
- [13]. Egea-Alvarez, F. Bianchi, A. Junyent-Ferre, G. Gross, and O. Gomis-Bellmunt, "Voltage control of multi terminal VSC-HVDC transmission systems for offshore wind power plants: Design and implementation in a scaled platform," *IEEE Trans. Ind. Electron.*, vol. 60, no. 6, pp. 2381–2391, Jun. 2013.
- [14]. M. Sangeetha, R. Arivoli and B. Karthikeyan, "Control of Unified HVDC for Offshore Wind Power Plant," *International Journal for Scientific Research and Development (IJSRD)*, (ISSN: 2321-0613).
- [15]. M. Sangeetha, R. Arivoli and B. Karthikeyan, "A new breed nn based uhvdc for offshore wind power plant enhance the transient response" *International journal of trend in scientific research and development*, vol.2, no.3, pp.1095-1102.