

STOCHASTIC PERFORMANCE EVALUATION OF ENERGY LATENCY TRADEOFF IN WIRELESS SENSOR NETWORKS

Sachin Sharma¹, Dr. K C Roy², Dr. Dinesh Goyal³

¹²³ Department of Computer Engineering, Suresh Gyan Vihar University, Jagatpura, Jaipur

Abstract— Wireless Sensor Networks (WSN) forms core network of the forthcoming era of IoT. These networks consists of wireless nodes deployed wirelessly with the intent of sensing some physical parameter and sending the measured values to some base station. The transmission is done with the assistance of other nodes in the network working as routers. A sensing node comprises of a microcontroller, a sensing device and radio for transmission. Such a network finds diversified deployment applications and thus presents challenges to the network designers. The most critical parameter to be optimized is the network lifetime and the latency. A most critical aspect for wireless nodes is that these are deployed in large numbers to hostile and harsh conditions and are prone to failures at many times. Also, the nodes are battery driven, executing on low rate and low power consumption (LR-WPAN) protocols designed in such a way that even single Lithium ion battery runs for about 6 months. It is because of these reasons that protocols must be designed carefully to enable evenly battery consumption in all nodes, so as to maximize network lifetime with minimal packet loss.

A particular class of wireless sensor Networks is the Real Time WSN in which the time critical needs are to be managed. The contribution of this paper is twofold. It investigates the real time characteristics of the network at MAC Sublayer level in terms of a number of Guaranteed Time Slots (GTS) in the superframe structure. The optimal number of GTS in the superframe is to be chosen in such a way so as to ensure minimum latency and maximum network lifetime. Secondly, it presents a tradeoff of latency and data aggregation at the application layer and gives the relationship between the two in the context of network lifetime. MATLAB is used as a simulation tool and the analytical results presented are in agreement with the simulation model.

Index Terms— Stochastic Modeling, WSN, Latency, Data Aggregation, MAC Sub-layer, Superframe, Network Lifetime

I. INTRODUCTION

Wireless Sensor Network (WSN) [1] refers to a network of sensing devices, commonly referred to as nodes, which senses some physical quantity and then sends the measured value to some central computer for subsequent action. As the name suggests, these devices act as nodes of the network which shares the data wirelessly. These networks find tremendous applications ranging from commercial to scientific to academia domains. Popular deployments of wireless sensor networks include fire sensors, temperature sensors, heat sensors, radiation sensors, humidity sensors, pressure sensors, etc. The applications of sensors are continuously increasing in the recent years for automation as well as other activities of daily life. Cloud and Big Data analysts [2] refer to the modern internet as the internet of things in which physical devices can communicate with each other depending on the measured parameters and other conditions.

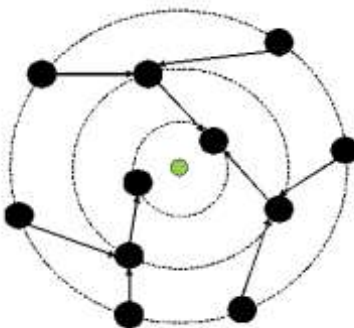

Fig. 1.1 Generic Illustration of Wireless Sensor Network

For example, a refrigerator can send a request to a dairy booth or a milk supplier if it is programmed suitably to send a request in case it does not have milk on some Sunday morning. Applications similar to this and much more in diversified domains can be built and there are endless possibilities for WSN changing the modern living to a larger extent, thereby turning the current internet to the Internet of things. A generic diagram of WSN is as shown in figure 1.1

The basic architecture of a WSN node is depicted in figure 1.2. The major components of a wireless sensor node or mote are:

1. A microcontroller unit for managing the overall operation of the Node Unit.
2. A sensing device (sensor).
3. Analog to digital convertors for conversion of measured value to variable values.
4. Battery for power supply
5. Radio circuitry for transmission.

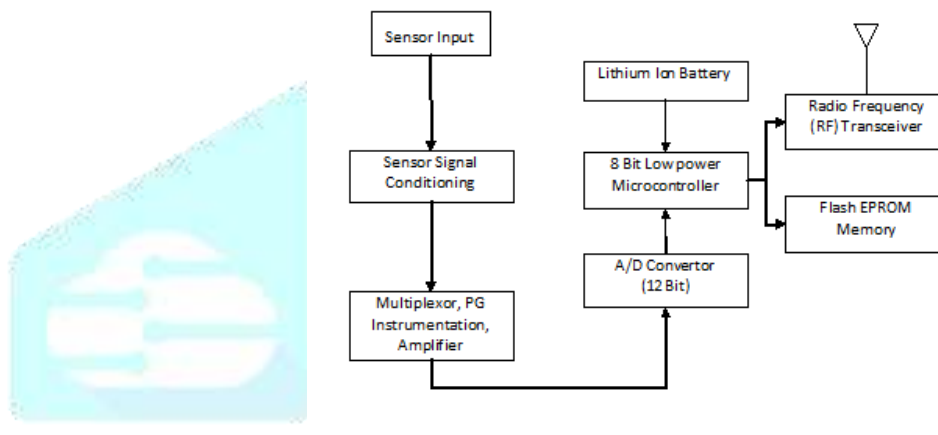

Fig. 1.2 Wireless Sensor Nodes (Mote)

Wireless Sensor Network design has several issues to be considered. The most important issues pertaining to all types of the wireless sensor network are Energy Efficiency and Latency. An overview of these issues is given below:

1. **Energy Efficiency:** This is the most critical aspect of almost all kind of deployments of WSN. As Wireless Sensor Networks are deployed in places at which the sensor node has to continuously monitor for some quantity for a prolonged time without getting out of the battery, the nodes need to be designed with the idea of low battery consumption. For example, a fire sensor at the ceiling of corridor of an office building must have to continuously sense for fire situation even for a year or long, so that in case of fire, the message regarding the same can be conveyed to some central computer to turn the alarms and to give an auto-call to the fire rescue team. WSN nodes are designed in such a way that it consumes very low power. Wireless Sensor network protocols are also low power consumption protocols. In fact, the IEEE standards for wireless sensor network nodes are also known as Low Rate and Low Power protocols [3,4]. Often, the battery life for a period of about one and a half or two years is common. This period is further increased by optimizing the duty cycle of the nodes. It refers to making the nodes periodically sleep for a certain period of time and then wakes up to sense the data. The energy consumption in the sleeping period is far less as compared to that in the wake-up or active period [5], thereby enhancing the battery life to a substantial limit. However, the sleep and wake up time are kept in the order of microseconds for most applications so as to justify the purpose of wireless sensor network.
2. **Latency:** The latency refers to the delay between the events of sensing something and the time instant at which the requisite action takes place. Most of the deployments of WSN come with the requirement of low latency. The requirement of low latency is critical for human rated systems such as radiation level sensors [6] in nuclear power plants and temperature sensors in thermal power plants. Latency beyond a certain limit is not permissible at all in systems and applications of IoT.

Wireless Sensor Network has conflicting requirements to run on Low Energy and Low latency. As the networks are designed keeping in mind the factor of low energy consumption, the latency of the overall system increase. If fast circuit and/or large transmission range is incorporated in WSN to reduce latency, the energy consumption increases. Thus, the two requirements tend to conflict each other and an optimal solution needs to be developed as per the requirements of the deployment.

There are several other issues that need to be considered. The same information can be recorded by several sensor nodes and supplied to the base station leading the data redundancy. Also, the large mass of information can be aggregated and then should be transmitted to the base station so as to avoid multiple transmissions. Various policies regarding these issues must be carefully thought of and then incorporated. Thus, several issues need to be considered before optimal deployment of WSN to any premise. The specifications for wireless sensor networks are standardized by IEEE in the specification for 802 wireless families of the specification. The IEEE 802 families of standards are specified for only Physical and MAC layers. The rest of the specifications are left to device manufacturers. Wireless Sensor Networks are specified under Wireless Personal Area Network (WPAN) Family of specifications and comes with IEEE 802.15.4 specifications [7]. These are low battery consumption and low data rate networks, thus are also abbreviated as LR-WPAN (Low Rate Wireless Personal Area Networks).

II. REVIEW OF IEEE 802.15.4 LR-WPAN STANDARD

IEEE 802.15.4 comprises of Physical and MAC layer specification for Low Rate Wireless Personal Area Network (LR-WPAN). The core techniques are inherited by WLAN [8,9]. An LR-WPAN is an easy and inexpensive communication network that permits wireless connectivity in applications with good throughput requirements and limited power supply. The major objectives of an LR-WPAN are reliable data transfer, ease of installation, extremely low cost, short-range operation, and a rational battery life, at the same time as maintaining a flexible and simple protocol. Some of the features of an LR-WPAN are

1. Star or peer-to-peer operation
2. Over-the-air data rates of 20 kb/s, 40 kb/s, and 250 kb/s
3. Allocated 16 bit short or 64 bit extended addresses
4. Carrier sense multiple access with collision avoidance (CSMA-CA) channel access
5. Allocation of guaranteed time slots (GTSs)
6. Fully acknowledged protocol for transfer reliability
7. Low power consumption
8. Energy detection (ED)
9. Link quality indication (LQI)

There are two types of devices which can take part in an LR-WPAN network; reduced-function device (RFD) and a full-function device (FFD). FFD can function in three modes mainly as a personal area network (PAN) coordinator, device or a coordinator. An FFD can interact with other FFDs or RFDs, at the same time an RFD can interact with only to an FFD. An RFD is designed for applications that are exceptionally simple for example, a passive infrared sensor or a light switch. They may be associated with only single FFD at a time and may need to transfer the bulk of data. As a result, the RFD can be implemented using very few resources and memory capacity.

2.1 Components of the IEEE 802.15.4 WPAN

A system in agreement to IEEE 802.15.4 consists of numerous components. The essential one is the device. A device can be RFD or FFD. More than two devices within a Personal Operating Space (POS) interacting on the similar physical channel comprise of a WPAN. Though, a network shall contain at least one FFD, which is working as the PAN coordinator. IEEE 802.15.4 network is a division of the WPAN family of standards even though the exposure of an LR-WPAN may expand beyond the POS, which naturally defines the WPAN. Little changes in direction or position might result in radical differences in the signal quality or strength of the communication link. A clear coverage area does not exist for wireless media since propagation characteristics are uncertain and dynamic.

2.2 Network Topologies [10, 11]

Depending on the application requirements, the LR-WPAN may operate in either of two topologies: the star topology and peer-to-peer topology. The communication is established amid devices and a single central controller, known as the PAN coordinator in a star topology. A device typically has some associated application and is either the initiation point or the termination point for network communications. A PAN coordinator may also have a specific application, but it can be used to initiate, terminate, or route communication around the network. The PAN coordinator is the prime controller of the PAN. All the devices which are operating on a network of these topologies must be having unique 64 bit extended addresses. This address can be used for direct communication within the PAN, or it can be interchanged with a short address allocated by the PAN coordinator whenever the device associates. While the devices will most probably be battery powered, the PAN coordinator might be mains powered. There are several applications which are benefitted from a star topology. These include personal computer (PC) peripherals, home automation, toys and games, and personal health care. The peer-to-peer topology also consists of a PAN coordinator; though, it differs from the star topology in that two devices can communicate with each other if they are in the range of each other. More complex network formations can be implemented using Peer-to-peer topology, such as mesh networking topology. Applications such as wireless sensor networks, industrial control and monitoring, asset and inventory tracking, intelligent agriculture, and security would benefit from such a network topology. A peer-to-peer network can be self-organizing, ad hoc and self-healing. It might also allow multiple hops to route

messages from one device to another device on the network. Such functions can be added to the network layer.

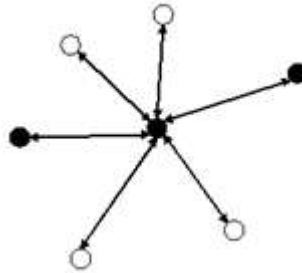

Fig. 2.1 Star Topology Network

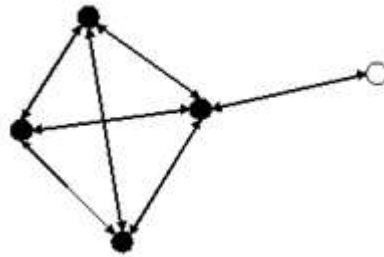

Fig. 2.2 Peer-to-Peer Topology Network

2.3 Star network formation

The basic structure of a star network can be seen in Figure 2.1. An FFD might set up its own network and turn out to be the PAN coordinator once it is activated for the first time. All star networks operate independently from all other star networks currently in operation. This is achieved by choosing a PAN identifier, which is presently not in use by another network inside the radio sphere of power. Once the PAN identifier is chosen, the PAN coordinator can allow other devices to join its network; both FFDs and RFDs may join the network.

2.4 Peer-to-peer network formation

In a peer-to-peer topology, each device is capable of communicating with any other device within its radio sphere of influence. One device will be nominated as the PAN coordinator, for instance, by virtue of being the first device to communicate on the channel. Further network structures can be constructed out of the peer-to-peer topology and may impose topological restrictions on the formation of the network. An example of the use of the peer-to-peer communications topology is the cluster-tree.

2.5 Cluster Tree Topology [12]

The cluster-tree network is a part of a typical peer-to-peer network consisting most of the devices to be FFDs. RFD might attach to a cluster tree network being a leaf node at the end of a branch, since it may only associate with one FFD at a time. Any of the FFDs may provide synchronization services to other devices or other coordinators and may itself act as a coordinator. Only one of these coordinators can be the overall PAN coordinator, which may have greater computational resources than any other device in the PAN. The PAN coordinator forms the initial cluster by representing itself as the cluster head (CLH) along with a cluster identifier (CID) of zero, an unused PAN identifier is chosen, and beacon frames are broadcasted to nearby devices. A candidate device getting a beacon frame may ask for joining the network at the CLH. The device will insert the new device as a child device in its neighbor list if the PAN coordinator allows the device to unite. Then the recently joined device will append the CLH as its parent in its neighbor list and starts sending periodic beacons. The network may be joined at the network by other candidate devices. If the original candidate device is not able to join the network at the CLH, it will search for another parent device. The simplest form of a cluster tree network is a single cluster network, but larger networks are possible by forming a mesh of multiple neighboring clusters. Once the applications or network requirements which are predefined are met, the PAN coordinator might instruct a device to turn into the CLH of a new cluster adjoining the first one. Other devices gradually connect and form a multi-cluster network structure. The advantage of a multi-cluster structure is increased coverage area, while the disadvantage is an increase in message latency.

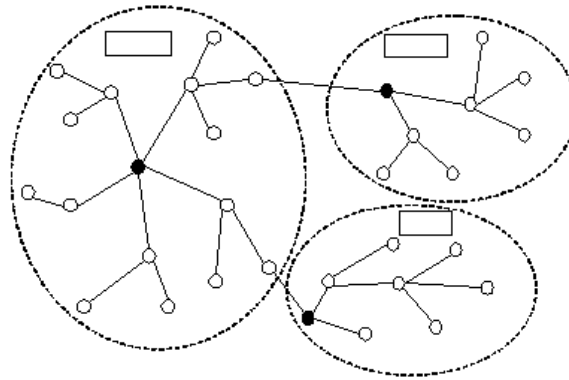

Fig. 2.3 Cluster Tree Topology Network

III. THROUGHPUT COMPUTATION OF THE GTS ALLOTMENT PROCESS IN THE CFP

3.1 Superframe Structure in IEEE 802.15.4 MAC

The abstract view of the superframe at MAC layer of IEEE 802.15.4 can be depicted as shown in figure 3.1.

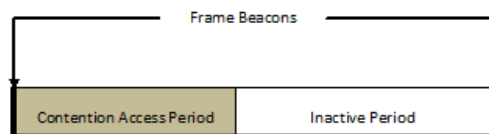

Fig 3.1 Frame Structure of superframe of IEEE 802.15.4 MAC [13]

It is evident from the figure that there exist frame beacons followed by Contention Access Period (CAP) which is followed by the inactive interval. The inactive period is again followed by a beacon signal. This structure is particular to the application which uses slotted time. In the case of un-slotted (or pure) time, the beacon signal may or may not be present.

In the case of Real time applications, the Contention Access Period is optionally followed by a Contention Free Period (CFP) consisting of Guaranteed Time Slot (GTS) which are reserved for the devices that have the time critical data to send to the base station or to the coordinator. A more detailed illustration of the superframe structure in such deployments is depicted in figure 3.2.

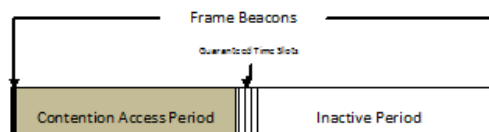

Fig. 3.2 GTS in CAP in Superframe

The GTS provision in MAC in WSN is primarily considered due to the real time requirements of the WSN. The basic mechanism of data transmission at MAC is CSMA/CA (Carrier Sense Multiple Access with Collision Avoidance). The parametric description of superframe structure is depicted in figure 3.3.

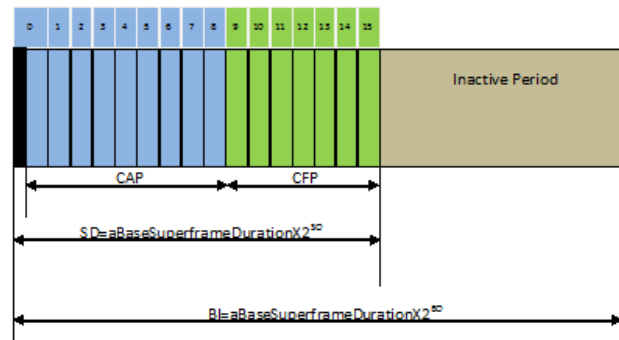

Fig. 3.3 Superframe Structure with Parameter Specification

The maximum slots for GTS that can be allocated are 7. This is because the length of the CAP must be at least equal to `aMinCAPLength`. The scheduling of the GTS is one of the most important issues that are still not evaluated analytically. Most of the models suggested by various researchers are simulative in nature and do not match to the analytical model as per the distribution of the data packets that are transmitted from various nodes.

As shown in figure 3.3, the superframe consists of two portions, viz, the active part and the inactive part. The active part consists of the CAP and optional CFP consisting of GTS slots. The minimum length of the CAP is kept to a threshold value given by `aMinCAPLength` to ensure that the MAC commands still be transferred to the nodes and to the PAN coordinator.

The structure of the superframe is specified by two variables namely Beacon Order (BO) and Superframe Order (SO). These are denoted by the variable `macBeaconOrder` and `macSuperframeOrder` respectively. The Beacon Interval is related to the `macBeaconOrder` (BO) with the following equation:

$$BI = aBaseSuperframeDuration \times 2^{BO} \text{ for } 0 \leq BO \leq 14$$

For `BO = 15`, the value of SO is ignored and it refers to the state in which the superframe does not exist.

Similarly, the superframe duration (SD) is defined by the following equation:

$$SD = aBaseSuperframeDuration \times 2^{SO} \text{ for } 0 \leq SO \leq BO \leq 14$$

The superframe duration SD is divided into equally spaced `aNumSuperframeSlots` which consist of a beacon, a contention access period and contention free period.

The beacon at the start signifies the activation of the nodes and the network and it is immediately followed by the Contention Access Period. The slot of the beacon at the start is labeled as slot 0. The CAP follows with slot numbered 1. The deployments of the WSN that does not wish to use the Beacon Enabled mode set that value of both the BO and SO to 15 which indicates beacon free transmissions and uses another method of receiver activation and management of duty cycles. All these operations are performed using the unslotted CSMA/CA mechanism.

The MAC command operations are always transmitted in CAP. As mentioned previously, the minimum length of the CAP of the superframe is `aMinCAPLength`. The size of the CAP grows or shrinks on the basis of the total number of GTS requests that comes to the coordinator during CAP.

The MAC layer needs a certain amount of time period to process the data received from the underlying physical layer. To accommodate this, all the frame transmissions are followed by an Inter Frame Spacing (IFS) time period. If the transmissions are reliable, these needs to be followed by an acknowledgement frame. In this case, the IFS interval comes immediately after the reception of the acknowledgement frame. Short frames are followed by short IFS period (called SIFS) and long frames are followed by long IFS period (called LIFS) period. The IEEE 802.15.4 maintained the scheme in the way that the frame of size at a max of `aMaxSIFSFrameSize` in length are followed by SIFS period of at least `aMinSIFSPeriod`. The frames of size greater than `aMaxSIFSFrameSize` are followed by LIFS period of at least `aMinLIFSPeriod`.

3.2 Analytical Model Specifications

Consider the scenario of a cluster based wireless sensor network as per the following specifications:

TABLE 3.1
MODEL SPECIFICATIONS FOR MATLAB SIMULATION

Parameter	Variable Name
Number of Nodes in the Cluster	N
Physical Dimension of Cluster	a x a
Mean Number of Data Packets Generated by nodes per time frame	λ
Mean Number of requests for Time Critical Data Packets Generated by nodes per time frame	η

3.3 Data Frame Traffic Modeling without Carrier Sensing

The dependence of the number of GTS time slots over the mean number of data packets can be derived using Poisson Distribution as follows:

The probability of transmissions of k data packets in a time slot, which is referred to as aBaseSuperframeDuration, is given by

$$P_{k(\text{Data Frames})} = \frac{\lambda^k * e^{-\lambda}}{k!}$$

On the similar lines, the probability of transmissions of k requests for time critical data packets in a time slot is given by

$$P_{k(\text{GTS Requests})} = \frac{\eta^k * e^{-\eta}}{k!}$$

It is assumed that all the time critical data packets are sent in allocated GTS time slots. The nodes wishing to transmit time critical data packets need to submit a request regarding the allocation of GTS. The packets can only be transmitted if the GTS is allocated to the node. The data packets and the requests for GTS time slots are both transmitted during Contention Access Period.

Any of the nodes can either send a data frame or a GTS request. The probability of successful transmission of either of them is exactly the same and relates to the throughput of the system.

If carrier sensing is not used, then all the nodes that wishes to transmit data packets can transmit the packets without sensing the medium. In that case, the throughput of the WSN cluster can be obtained by transmission probability as specified by the probability distribution.

Let there be N nodes in the system and each node transmits data frame with a probability p_1 during a frame time. Thus, the average number of data frame generated during frame time is $N.p_1$. Also let each node transmits a GTS request with probability p_2 during frame time. Thus, the average number of GTS request generated during frame time is $N.p_2$. Thus, $\lambda = N.p_1$ and $\eta = N.p_2$.

The cumulative probability of packet transmission during the frame transmission time (referred to as a Base Super frame Duration) is $\lambda' = N.(p_1+p_2)$.

The probability of k frame transmissions per unit frame time is given by:

$$P_k = \frac{\lambda'^k * e^{-\lambda'}}{k!}$$

The probability of zero transmission of data packets per unit frame time is given by:

$$P_{k=0} = e^{-\lambda'}$$

The throughput of the system can be defined as:

Throughput =

mean number of Packets transmitted during frame time * Probability of successful transmission of data packet'

$$T = \lambda' . P_{k=0} = \lambda' . e^{-\lambda'}$$

Substituting the value of λ' gives

$$T = \lambda' . P_{k=0} = N. (p_1 + p_2). e^{-N.(p_1+p_2)}$$

Let $N. (p_1 + p_2) = R$. Thus,

$$T = R. e^{-R}$$

To, find the max and min of this function, the zeros of the derivation must be figured out. Thus,

$$\frac{dT}{dR} = R(-1). e^{-R} + e^{-R} = 0$$

which gives $R = 1$. Thus, for $R = 1$, $T = 1/e = 0.36$ which is the maximum achievable efficiency in case of slotted transmission without carrier sensing.

To verify the same, one can obtain the second order derivative.

Thus

$$\frac{d^2T}{dR^2} = (-1). e^{-R} - [R.(-1)e^{-R} + e^{-R}] = -2e^{-R} + Re^{-R} = -e^{-R} \text{ for } R = 1$$

The negative value of the second derivative ensures that the point corresponds to $R = 1$ is a point of local maximum. The restriction for $R = 1$ for maximum throughput indirectly implies

$$R = N(p_1 + p_2) = 1$$

This gives an insight into traffic modeling in context of data frames and GTS request probabilities and the number of nodes, so as to achieve the maximum throughput.

The validity of the equation for maximum throughput can be justified in another way. Consider a particular time slot. The probability that only a single user transmits during this time slot and no other user transmits any data/GTS frame is:

$$(p_1 + p_2)[1 - (p_1 + p_2)]^{N-1}$$

The average number of messages (<1), that can go through this time slot (Throughput) is

$$N \cdot (p_1 + p_2)[1 - (p_1 + p_2)]^{N-1}$$

For simplicity, let $p_1 = p_2 = p$, then one can rewrite the equation as:

$$T = N \cdot 2p(1 - 2p)^{N-1}$$

The maxima or minima of this function can be achieved by differentiating this function w.r.t p .

$$\frac{dT}{dp} = 2Np(N-1)(1-2p)^{N-2} + (1-2p)^{N-1}(2N) = 0; \text{ For max. or min.}$$

$$2Np(N-1)(1-2p)^{N-2}(-2) + (1-2p)^{N-1}(2N) = 0$$

$$-2p(N-1) + (1-2p) = 0$$

$$-2pN + 2p + 1 - 2p = 0$$

$$1 - 2pN = 0$$

$$p = 1/2N$$

Thus, this function achieves its maximum value at

$$p = \frac{1}{2N}$$

This can be verified by obtaining the second derivative of the first order derivative and substituting the value of p .

Substituting this value, the average number of successful transmission in a frame time is:

$$\left(1 - \frac{1}{N}\right)^{N-1}$$

When the number of nodes is large,

$$\lim_{n \rightarrow \infty} \left(1 - \frac{1}{N}\right)^N = \frac{1}{e} = 0.36$$

This proves the validity of the above derivations. Section 4 gives the plots for throughput efficiency for range of values of data frames.

3.4 Non Persistent CSMA (NP- CSMA)

The mechanism of NP CSMA is the simplest of all the techniques. It transmits using the following algorithm:

1. When there is a packet to send, then the node senses the medium. If the medium is idle, then it transmits immediately.

2. If the medium is busy, then it waits for the random amount of time and then senses the medium again. Then it follows step 1.

In a slotted variant, the timeline is divided into slots. Before attempting for a transmission, the node waits for the start of the next slot and checks the medium for being idle. If the medium is found idle, then it transmits the packet which can take any number of time slots. If the channel is found busy, then the sensing is rescheduled for some next time slot, repeating the procedure again.

In this literature, the term data packet and data frame has been used interchangeably. All the data frames to be transmitted by the nodes need to be acknowledged. If the data frame meets with some collision or left unacknowledged, then the packet needs to be transmitted again. It is assumed that the size of the acknowledge frame is small and all the acknowledgement frames are received within the same time slot without any collision. This is a strong assumption and the consequences of considering the fact into the system model is considered in the context of IEEE 802.15.4 GTS. As the packets need to be acknowledged, the packets cannot be discarded from the queue of the sending node until the sending node gets the acknowledgement signal from the receiver. The packets which arrives fresh at the MAC layer joins the queue at the sending node. All the packets which are competing to be transmitted by all the nodes forms the Head of the Line (HOL) frames. These HOL frames contend for transmission as illustrated in the figure 3.4.

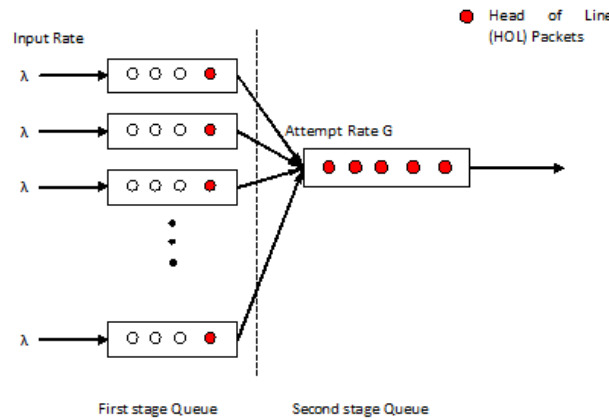

Fig 3.4 System Queue Model for NP CSMA

Let the transmission time of the data frame be normalized to 1 and the propagation time be a. The transmission time refers to the time it takes for the sending node to put all the bits of the data frame onto the transmission channel. The propagation time is the time it takes for the single bit to travel from the transmitter to the receiver. As mentioned previously, there exists two ports on each node to transmit and to listen to the channel at the same time, the channel status at independent level and as seen by the nodes. The channel can be in any one of the states, namely; idle, successful transmission, or collision. The state transition of the CSMA channel can be depicted as shown in figure 3.5.

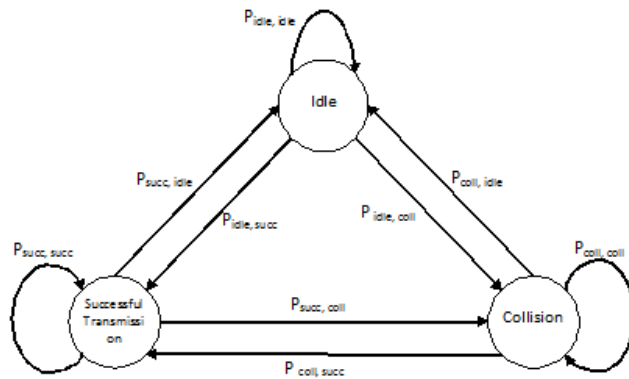

Fig 3.5 State transition diagram of Transmission Channel of NP-CSMA

The limiting (or steady state probabilities) of the Markov chain depicted in figure 3.5 follows the set of equations as mentioned below. Here, $P_{idle, succ}$ refers to the state transition probability from the idle state to the successful transmission state. Other probabilities can be explained in the same ways. Also, π_{idle} refers to the steady state probability of the system being in the idle state.

$$\pi_{idle} = \text{Steady State (Limiting)}$$

$$\text{Probability of the system being in the idle state} = P_{idle, idle} \cdot \pi_{idle} + P_{succ, idle} \cdot \pi_{succ} + P_{coll, idle} \cdot \pi_{coll}$$

Thus

$$\pi_{idle} = P_{idle, idle} \cdot \pi_{idle} + P_{succ, idle} \cdot \pi_{succ} + P_{coll, idle} \cdot \pi_{coll}$$

Likewise

$$\pi_{succ} = P_{idle, succ} \cdot \pi_{idle} + P_{succ, succ} \cdot \pi_{succ} + P_{coll, succ} \cdot \pi_{coll}$$

$$\pi_{coll} = P_{idle, coll} \cdot \pi_{idle} + P_{succ, coll} \cdot \pi_{succ} + P_{coll, coll} \cdot \pi_{coll}$$

The above equations can be explained as in a straight manner. The probability of being in any of the three states is equal to the sum of the product of the probability of being in any of the state multiplied by the state transition probability from that state to the target state. As the nodes attempt to transmit the data frames to the channel only when the channel is idle, the attempt rate in the busy period is zero. Also, during the idle period, all the fresh generated packets and all the rescheduled packets forming the Head of the Line (HOL) follows a Poisson Probability distribution with mean value G per unit time. Thus, the probability of k attempts during the idle period (length a) is given by:

$$P_k = \frac{(aG)^k * e^{-aG}}{k!}$$

The probability that no attempts generated during the time slot of length a is:

$$P_{k=0} = e^{-aG}$$

The transmission is successful if and only if a single packet is attempting in the time slot the probability for which is given by

$$P_{k=1} = aG * e^{-aG}$$

Hence, the transition probabilities are given by:

$$\begin{aligned} P_{idle, idle} &= P_{succ, idle} = P_{coll, idle} = e^{-aG} \\ P_{idle, succ} &= P_{succ, succ} = P_{coll, succ} = aG * e^{-aG} \\ P_{idle, coll} &= P_{succ, coll} = P_{coll, coll} = 1 - e^{-aG} - aG * e^{-aG} \end{aligned}$$

One can obtain the values of the steady state probabilities by substitution of the values of these transition probabilities to the equations described above.

The values of the steady state probabilities are derived from being:

$$\begin{aligned} \pi_{idle} &= e^{-aG} \\ \pi_{succ} &= aG * e^{-aG} \end{aligned}$$

and

$$\pi_{coll} = 1 - e^{-aG} - aG * e^{-aG}$$

The time average probabilities of the three states of the channel can be obtained by normalizing the probabilities of the states of the system with those of the sojourn time of the states. The sojourn time refers to the mean stay time of the system in any of the stable states of the system. As the mean time length of the idle, successful and the busy period is given by:

$$t_{idle} = a$$

and

$$t_{succ} = t_{coll} = 1 + a$$

substituting the values yields

$$\hat{\pi}_{idle} = \frac{a * \pi_{idle}}{a * \pi_{idle} + (1 + a) * \pi_{succ} + (1 + a) * \pi_{coll}}$$

Also

$$\hat{\pi}_{idle} = \frac{a * e^{-aG}}{a * e^{-aG} + (1 + a)(1 - e^{-aG})}$$

and

$$\hat{\pi}_{coll} = \frac{(1 + a) * \pi_{coll}}{a * \pi_{idle} + (1 + a) * \pi_{succ} + (1 + a) * \pi_{coll}}$$

$$\hat{\pi}_{coll} = \frac{(1 + a) * (1 - e^{-aG} - aG * e^{-aG})}{a * e^{-aG} + (1 + a)(1 - e^{-aG})}$$

$$\hat{\pi}_{succ} = \frac{(1 + a) * \pi_{succ}}{a * \pi_{idle} + (1 + a) * \pi_{succ} + (1 + a) * \pi_{coll}}$$

$$\hat{\pi}_{succ} = \frac{(1 + a) * (aG * e^{-aG})}{a * e^{-aG} + (1 + a)(1 - e^{-aG})}$$

$$\hat{\pi}_{succ} = \frac{(1 + a) * (aG * e^{-aG})}{a * e^{-aG} + 1 + a - a e^{-aG} - e^{-aG}}$$

$$\hat{\pi}_{succ} = \frac{(1 + a) * (aG * e^{-aG})}{1 + a - e^{-aG}}$$

Since the successful transmission of the packet takes time which is equal to the fraction $\frac{1}{1+a}$, the throughput of the system can be defined as the probability of the channel to be in the successful state multiplied by the fraction of the transmission time. Thus, the throughput of the system is defined as:

$$T = \hat{\pi}'_{succ} = \frac{\hat{\pi}_{succ}}{1 + a} = \frac{(aG * e^{-aG})}{1 + a - e^{-aG}}$$

3.5 1-Persistent CSMA

The mechanism for 1-persistent CSMA can be illustrated as follows:

1. When there is a packet to send, then the node senses the medium. If the medium is idle, then it transmits immediately.
2. If the medium is busy, then it continuously senses (that's why known as persistent) for the medium to become free, and then transmits immediately.
3. If a collision is detected, then it waits for the random amount of time (called backoff period) and then repeats the steps.

The modeling of persistent CSMA can be done as follows:

Let there be N nodes in the system sharing a medium m. Also, let the rate of data frame generation for each node is λ and the probability distribution for the packet generation follows Poisson Distribution.

Let there be M backlogged nodes in the network and N-M nodes having new arrivals of data frames which are Poisson Distributed with mean λ . The probability of r fresh arrivals during a time slot is

$$P_{k=r} = \frac{\lambda^r * e^{-\lambda}}{r!}$$

The probability that no fresh arrival takes place during a time slot is:

$$P_{k=0} = e^{-\lambda}$$

Thus, the probability that one or more fresh arrivals take place during a time slot is

$$Q_K = 1 - e^{-\lambda}$$

It follows that there is two type of transmissions in each slot as defined below:

Type 1 : Transmissions which are initiated by nodes which sense the medium and immediately find it idle.

Type 2: Transmission which senses the medium being busy and then persistently waits for it to be free, due to the persistence property of CSMA.

There are two different probabilities of success for both these types of transmissions.

Transmission of type 2 is successful if there is only a single node waiting for the medium to get free.

There are three fundamental states of the medium, namely : idle, successful transmission and collision. The successful states have two sub-states, viz, success_1 and success_2 corresponding to type 1 and 2 described above.

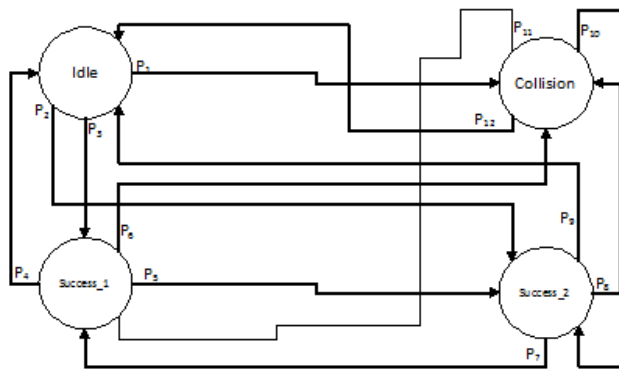

Fig 3.6. State Transition Diagram of Transmission Channel

The state transition probabilities can be derived in a similar manner for persistent CSMA as in the case of non-persistent CSMA.

3.6 P-Persistent CSMA

The context of P Persistent CSMA is analyzed as it yields to a more generic model which can be customized to persistent and non persistent modes with $P=1$ and $P<1$ respectively. Here, the term P is used to denote the persistence parameter and it is different from the probability p used in the previous context. Nevertheless, both p and P denote the probabilities. The variable p defines the probability that a node has data to send whereas the parameter P denotes the persistence. With $P=1$, the node transmits with a probability P when it has data to send, known as persistence CSMA.

The CSMA/CD is feedback loop controlled as depicted in the figure 3.7. Thus the probability p of packet transmission cannot be assumed to be a single value. The probability rises in case of congested network as a result of collision and the probability to transmit can be reduced as a result of large value of backoffs.

The throughput of CSMA/CD can be evaluated using the count of time slots over a long duration. The throughput can be thought of as the number of time slots which are used to carry data frame, divided by the number of time slots that carry collided frame or does not carry any frame at all. This fraction can be more appropriately termed as channel utilization.

The Markov model for CSMA/CD is constructed considering the number of nodes having fresh data packets to be transmitted as well as the number of backlogged nodes. A backlogged node is one having data packets pending to be transmitted. These are the data packets which were previously send by the nodes but met with collision or left unacknowledged. Let M denote the number of backlogged nodes at the start of a time slot. Each of the node in the network having backlogged or new data packet to send to PANC can transmit at the start of a time slot with probability p. Assuming that there are N nodes in the network, there are N-M non-backlogged nodes in the network which transmit the packets, also with probability p. Assuming that there new packets are generated by each node with Poisson process with mean value of λ per time slot, the probability of k packets generated during a time slot is:

$$P_k = \frac{\lambda^k * e^{-\lambda}}{k!}$$

The probability of no new data frame generated by the nodes is $P_k = e^{-\lambda}$. After every unsuccessful attempt of data transmission, the number of backlogged data packets to be transmitted increases by one. After every successful transmission, this count decreases by one. Also, new packets are generated at each node with mean rate λ , following the Poisson Distribution. The state of the system can be described by the number of backlogged data packets n at the start of the time slot .

$$P_{k=0} = e^{-\eta}$$

If t_{trans} be the transmission time and t_{prop} be the propagation time of the frame, then the vulnerable period in case of data frame is defined as:

$$t_{vulnerable, data} = t_{trans, data} + t_{prop}$$

The vulnerable period is defined as the time period in which there is a probably of collision in data packets. The term $t_{trans, data}$ signifies that it refers to the transmission time of the data frame. The transmission time refers to the time period it takes for the nodes to put all the bits of the frame onto the transmission channel. The propagation time, on the other hand, refers to the time it takes for a single bit to travel from the sender to the receiver.

On the similar lines as specified above, the vulnerable period in case of transmission of GTS request is:

$$t_{vulnerable, GTS} = t_{trans, GTS} + t_{prop}$$

The mean of the vulnerable period can be derived by the weighted averages of the probability distribution of the transmission of data packets and the GTS requests.

$$t_{vulnerable} = \frac{\lambda * t_{vulnerable, data} + \eta * t_{vulnerable, GTS}}{\lambda + \eta}$$

The average (mean) number of packets transmitted during vulnerable period, including both GTS and data transmissions is given by:

$$K = \lambda * t_{vulnerable} + \eta * t_{vulnerable}$$

The probability of zero transmission during the vulnerable period is:

$$P_{k=0} = e^{-K}$$

In the absence of carrier sensing, the throughput of the system is defined as:

$$S = K * P_{k=0}$$

However, as carrier sensing is used along with CSMA/CA, it facilitates the throughput of the system much more as compared to that without sensing as in slotted/pure ALOHA.

In CSMA/CA, along with carrier sensing, RTS and CTS signaling is used to eliminate hidden and exposed terminal problem. This formulation assumes both the case of stationary nodes as well as the mobile nodes.

It is further assumed that the data transmission scheme follows a reliable data transmission in which the transmission of each packet is followed by reception of the acknowledgement.

If, the RTS-CTS setup before data transmission is not considered, even then in reliable data transmission, during the CAP, the data packet transmission from a node to the PAN coordinator is followed by an acknowledgement signal. If the size of the acknowledgement frame is neglected, even then the propagation delay has to be taken into account. The vulnerable period in case of acknowledgement signals can be defined as:

$$t_{vulnerable, data} = t_{trans, data} + 2 * t_{prop}$$

The term for propagation is multiplied by 2 to take into account the propagation delay of data packet as well as the corresponding acknowledgement signal.

3.7 Petri Net Analysis of the Stochastic Model

The model can be worked out using stochastic Petri net which defines a way to derive the parametric solutions to the stochastic models. The model can be designed in terms of token, places and transitions. The Petri net corresponding to the problem can be designed as shown:

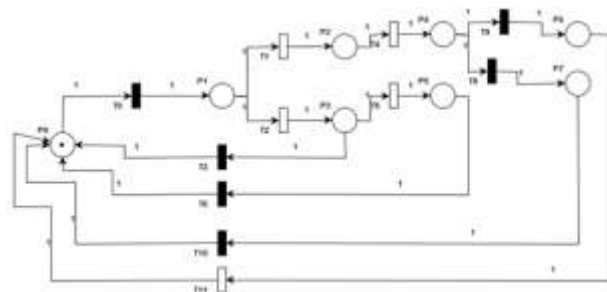

Fig. 3.7 Stochastic Petri Net Analysis of WSN MAC

Token at place P0 indicates that any of the nodes has data to transmit to the PAN coordinator. More than one token at place P0 indicates that there is more than one node currently having data to be transferred to the PAN coordinator. This is connected to place P1 with immediate transition T0. A token at place P1 indicates sensing the carrier for being free, using CSMA techniques. A token at place P2 indicates that the medium is found free and that RTS signal corresponding to the packet transmission has been sent. A token at place P3 indicates that the medium is found busy and that the sender has to wait for a random back-off period. This again follows to the token at place P0 as per the definition of P0 to make the workflow simple.

A token at a place P4 indicates that CTS signal corresponding to the RTS sent has been received. Conversely, a token at a place P5 indicates that the CTS has not been received, and this place eventually leads to P0 through the immediate transition. A token at a place P6 assumes successful packet transmission (either data packet or GTS) and a token at a place P7 indicates packet collision as a result of mutual transmissions.

The simulation results for various values of the timed transactions is derived in section 4.

IV. PERFORMANCE ANALYSIS OF DATA AGGREGATION, LATENCY AND ENERGY CONSUMPTION IN CLUSTER BASED WIRELESS SENSOR NETWORKS

4.1 Conflicting requirements of Clustering, Data Aggregation and Latency

A wireless sensor network has energy consumption as its most critical issue that needs to be treated most efficiently as the sensor nodes need to be deployed at the places where these need not be maintained on a frequent basis. What is expected from a sensor node is to continue its working on a single AA battery even for an year or two. For this reason, the sensor node uses low range radios to save energy in data transmission. To realize this implementation, the node needs to be clustered so that all the nodes in certain proximity send the data to a single node called the PAN coordinator and the coordinator then transmits the data to the central base station.

This clustering approach has two advantages. First, it reduces the need of long range radios to enable the transmission from all the nodes to the PAN coordinator. Secondly, it reduces the size of the data to be transmitted as a whole. This is because some form of the data aggregation can take place at the PAN coordinator and the summarized value needs to be transmitted to the central gateway in most of the cases. Both these factors contribute towards reducing the energy consumption to a significant extent.

However, the major drawback associated with clustering technique is the time delay that is introduced as a result of transmission to the PAN coordinator and the Data aggregation, thus making it incompatible for real time WSN.

4.2 Analytic Model of Relationship between Data Aggregation, latency and Energy Consumption

The Figure 4.1 clearly depicts that the requirements of Data Aggregation and Latency are conflicting and one needs to decide an optimal point in the horizontal plane of figure 4.1 for deployment of the specific type of sensor network. The goal of this work is to figure out a generalized model of the WSN considering the Clustering, and data aggregation policies and relate then to the energy consumption in the most accurate way as possible. This analysis basically investigates the network at the application layer and incorporates the first order radio energy model. For clustering of the network, the most commonly used LEACH (Low Energy Adaptive Clustering Hierarchy) protocol is used.

The importance of Data Aggregation can be figured out from a simple computation described as follows. Consider the following values for the transmission and processing circuitry energy consumption:

Energy Required per bit in the Processing Circuit : 50nJ/bit

Energy required per bit in the transmission Circuit : 10pJ/bit/m²

For transmission of 1 kb for a distance of 1 km, the transmission circuit consumes $10 \times 10^{-12} \times 1024 \times 1000 \times 1000 = 0.01024$ Joules.

For processing of 1kb, the processing circuit requires $50 \times 10^{-9} \times 1024 = 5.12 \times 10^{-5}$. Thus, the ratio of transmission and processing is :

$$\frac{1024 \times 10^{-5}}{1024 \times 50 \times 10^{-9}} = 200$$

Thus 200 instructions can be executed for the same energy consumption as for the transmission of one instruction over the distance of 1 km. Moreover, it increases with the square of the distance. Thus, it is promising to use clustering techniques in WSN to allow for prolonged battery life.

4.3 Analytical Model of Clustering and Data Aggregation

The specification for the model parameters are given in table 4.1.

TABLE 4.1
PARAMETER VALUES FOR SYSTEM MODEL

Parameter	Values/Specifications
Hardware	ATMEL ATmega60
System Software	Tiny OS version 2.x
Energy Dissipation Model	First Order Radio Energy Dissipation
Clustering Mechanism	LEACH
Number of Nodes	N
Number of Clusters	K
Mean Number of Data Packets transmitted by each sensing node per unit time	λ
Data Packet Size	R bits
Physical Dimension of the Placement Area of the sensing nodes	$a*a$
Initial Battery power in each sensor node	P

The network model can be analyzed in its three variants :

1. Network with no Clustering, no data aggregation.
2. Network with Clustering, No data aggregation.
3. Network with Clustering and Data Aggregation.

The goal of this work is to analyze all the above three and derive an exact relationship curve for the three parameter as shown in figure 4.1. More exactly, we need to derive the relationship between latency and energy consumption for various values of the system parameters.

In each of the configurations described above, it is assumed that the sink is externally powered and all other nodes of the network, viz, the sensor nodes and the cluster heads are battery powered.

4.4 Network with no Clustering and no data aggregation

The energy Consumption per unit time in the network is given by

$$E = E_t + E_d + E_r$$

where

E_t = Energy Consumption in processing Circuit at Transmitting Nodes

E_d = Energy Consumption in transmission of data packets (all transmitting nodes)

$E_r = E_t$ = Energy Consumption in processing Circuit at Receiving Node(s)

Here,

$$E_d = E(\lambda * R * N, d)$$

and

$$E_r = E(\lambda * R * N)$$

where N is the number of nodes in the network, R is the data packets size, and λ being the mean number of packets sent per unit time by each node. Thus the energy consumption per unit time is given by:

$$E = e_{t1} * \lambda * R * N + e_{d1} * d^2 * \lambda * R * N + e_{r1} * \lambda * R * N$$

$$E = e_{d1} * d^2 * \lambda * R * N + 2 * e_{t1} * \lambda * R * N$$

The last term is due to the fact that both the processing circuitry at transmission and the reception consumes equal amount of power.

As there is no clustering, it can be assumed that the sink is at an optimal location and almost equidistant from all the nodes. For a square area of side a, the average distance of all the nodes from the sink can be assumed to be $a/2$. Thus, the energy consumption per unit time in the network is given by:

$$E = e_{d1} * (a/2)^2 * \lambda * R * N + 2 * e_{r1} * \lambda * R * N$$

The network lifetime in this case is given by:

$$Network\ Lifetime = \frac{N * P}{Energy\ Dissipated\ per\ unit\ time\ in\ the\ WSN\ by\ all\ nodes}$$

where P is the energy (initial battery power) of every node and N is the number of nodes in the network. Thus

$$N.L. = \frac{N * P}{e_{d1} * (a/2)^2 * \lambda * R * N + 2 * e_{r1} * \lambda * R * N}$$

This is the best case analysis of the Network lifetime as it implicitly assumes evenly energy consumption in all the nodes of the network. Even if the sink node is externally powered, the nodes in the field can transmit data unevenly due to which the energy dissipation in the nodes takes place at an uneven rate. At the time of realization of the sensor mote, the transmission range is defined. Thus, the network lifetime is independent of transmission distance a . However, the mean number of data packets transmitted by each node is uneven which leads to more rapid battery depletion in some of the nodes as compared to the others leading to a reduction in network lifetime. It is important to mention here that network lifetime is defined as the time since the network is operational till the moment at which the first node of the network runs out of the battery. In the above equation, the power dissipation is uneven due to the uneven transmission of the data packets by the nodes.

Assuming that the sink node is externally powered, the network lifetime can be well modeled by the following equation:

$$\text{Network lifetime} = \frac{P}{e_{d1} a^2 \lambda_{max} R + e_t \lambda_{max} R}$$

The numerator represents the initial battery power of the node and the denominator represents the max energy dissipation in any of the node in the network.

Let L₁ be the latency caused by the A/D converter at the transmission and L₂ be the latency caused in the receiving circuit. In this case, no latency is induced apart from these two as all nodes are connected to the central gateway in star topology. Thus, the overall latency induced in the WSN is:

$$L = L_1 + L_2$$

Assuming the equivalence of operations stated previously, the latency L₂ = N*L₁ as the receiver has to process data packets received from each of the node in the WSN. Thus, the latency in this configuration is given by:

$$L = (N + 1) * L_1$$

For the specifications mentioned in the table 4.2, the Network life and latency can be computed using the above equation.

TABLE 4.2
PARAMETER SPECIFICATION FOR MICA MOTES RUNNING TINY OS 2.x

Parameter	Value	Remarks
E _t	0.00000005 Joule per bit	Transmission Circuit Power Consumption
E _d	1*10 ⁻¹¹ Joule per bit per meter sq	Transmission Antenna circuit Power Consumption
E _r	0.00000005 Joule per bit	Receiver Circuit Power Consumption
N	1000	Number of Nodes
R	2040	Data Packet size in bits (=255*8)
K	5	Number of clusters
λ	~2	Data Packet traffic Per Unit Time
a	500	Size of Region (mtr. sq.)
P	6480 J	Initial Battery Power (0.9V*1 hr)

It is important to note that the network lifetime falls exponentially with the increase in the mean number of data packets transmitted by each node for a given transmission range of the antenna circuit. The latency in this case is minimum as no data aggregation at cluster head is involved in the network topology.

4.5 Network with Clustering and no data aggregation

Consider the same physical situation of WSN having n nodes and K clusters. Thus, the average number of nodes per cluster is N/K. The processing of information in each of the cluster takes the following parameters:

1. Let E_E be the energy consumption overhead in each of the cluster for Cluster Head election using LEACH. If the frequency of election is one in T time units, the per unit overhead of leader election is E_E/T.
2. For a square having side a, if the complete area is partitioned into K blocks corresponding to K clusters, then a direct measure would suggest that the side of each of the partition (possibly rectangle) is 2a/K. Thus the average distance of all the nodes of the cluster from the cluster-head is a/K.
3. On the basis of the results 1 and 2 as stated above, the Energy Consumption in each of the cluster is given by:

$$E_K = e_{t1} * \lambda * R * \left(\frac{N}{K} - 1\right) + e_{d1} * \left(\frac{a}{K}\right)^2 * \lambda * R * \left(\frac{N}{K} - 1\right) + e_{r1} * \lambda * R * \left(\frac{N}{K} - 1\right) + e_{d1} * \left(\frac{a}{2}\right)^2 * R * \lambda * \left(\frac{N}{K} - 1\right)$$

The first terms represents the energy consumption in the transmitted circuit of N/K-1 nodes of each cluster. The second term represents the energy consumption in the antenna circuit of all the nodes of the cluster. The third term represents the power consumption in the CH circuit in processing all the data packets arriving from all the Cluster members. The fourth term represents the power consumption in antenna circuit in transmitting all the data packets arriving at the cluster head.

This result can be explained in a simple way as for each cluster, the mean number of nodes transmitting at any time in the cluster is N/K and the mean distance is a/K.

It is assumed that after the election of the cluster head in any of the cluster, all the cluster members are informed to operate in the low transmission range mode of the order of cluster head while the cluster head itself operate in mode of high transmission range to enable it to transmit data to the sink node.

The overall energy dissipation in the WSN per unit time is:

$$E = K * E_K + K * E_E / T$$

The Latency involved in this network topology is more than the previous mode due to clustering.

Apart from the latency L₁ and L₂ stated previously, the latency involved due to clustering is

$$L_K = (N/K) * L_1$$

The overall latency in the WSN is

$$L = L_1 + \left(\frac{N}{K}\right) * L_1 + K * L_1$$

The parameter specification is same as given in the table 4.2 for MICA motes running Tiny OS 2.x.

4.6 Network with Clustering and Data aggregation

In this setting, the overall energy consumption in each of the cluster is given by:

$$E_K = e_{t1} * \lambda * R * \left(\frac{N}{K} - 1\right) + e_{d1} * (a/K)^2 * \lambda * R * \left(\frac{N}{K} - 1\right) + C * e_{r1} * \lambda * R * \left(\frac{N}{K} - 1\right) + e_{d1} * (a/2)^2 * Z * R$$

The first term of the above equation relates to the energy consumption in the nodes sensing the physical parameter. The second term relates to the energy dissipation in the transmission of data packets over a/k distance in all the nodes of the cluster. The third term related the energy consumption incurred in data aggregation and compression. The variable to emphasize on the overhead in the compression/ aggregation algorithm is denoted by C. The fourth term relates to the data transmission from the cluster head to the central gateway computer. Here Z is the compressed number of data packets.

As stated previously, the overall energy dissipation in the WSN per unit time is:

$$E = K * E_K + E_E / T$$

The overall latency in the WSN is

$$L = (n + 1) * L_1 + L_K + L_c$$

where L_c is the latency involved in the data compression.

4.7 Results and Analysis

The results are computed for the mica motes running Tiny OS and the corresponding values of the variable are assumed for the analytical and simulation modeling. The tabular values of the variables as per the three network configurations are as shown in the table 4.3.

TABLE 4.3
NETWORK LIFETIME (NL) AS A FINCTION OF CLUSTERING AND DATA AGGREGATION

λ	No Clustering-No Aggregation		Clustering-No Aggregation		Clustering-Aggregation	
	E (Energy Consumption)	NL	E	NL	E	NL
0.2	0.0002958	1.389313401	0.2924342	1.405304	0.148002	2.776708077
0.4	0.0005916	0.694656701	0.5848172	0.702713	0.270453	1.519519474
0.6	0.0008874	0.463104467	0.8772002	0.468489	0.392904	1.045951924
0.8	0.0011832	0.34732835	1.1695832	0.351372	0.515355	0.797428461
1	0.001479	0.27786268	1.4619662	0.2811	0.637806	0.644331937
1.2	0.0017748	0.231552234	1.7543492	0.234251	0.760257	0.540552466
1.4	0.0020706	0.198473343	2.0467322	0.200788	0.882708	0.465565975
1.6	0.0023664	0.173664175	2.3391152	0.17569	1.005159	0.408849567

1.8	0.0026622	0.154368156	2.6314982	0.156169	1.12761	0.364451212
2	0.002958	0.13893134	2.9238812	0.140553	1.250061	0.328751028
2.2	0.0032538	0.126301218	3.2162642	0.127775	1.372512	0.299420948
2.4	0.0035496	0.115776117	3.5086472	0.117127	1.494963	0.274895666
2.6	0.0038454	0.106870262	3.8010302	0.108118	1.617414	0.254083898
2.8	0.0041412	0.099236672	4.0934132	0.100395	1.739865	0.236201577
3	0.004437	0.092620893	4.3857962	0.093702	1.862316	0.220670853
3.2	0.0047328	0.086832088	4.6781792	0.087846	1.984767	0.207056477
3.4	0.0050286	0.081724318	4.9705622	0.082679	2.107218	0.195024371
3.6	0.0053244	0.077184078	5.2629452	0.078085	2.229669	0.184313845
3.8	0.0056202	0.073121758	5.5553282	0.073976	2.35212	0.174718496
4	0.005916	0.06946567	5.8477112	0.070277	2.474571	0.166072774
4.2	0.0062118	0.066157781	6.1400942	0.06693	2.597022	0.158242353
4.4	0.0065076	0.063150609	6.4324772	0.063888	2.719473	0.1511171
4.6	0.0068034	0.06040493	6.7248602	0.06111	2.841924	0.144605864
4.8	0.0070992	0.057888058	7.0172432	0.058564	2.964375	0.138632554
5	0.007395	0.055572536	7.3096262	0.056222	3.086826	0.133133153
5.2	0.0076908	0.053435131	7.6020092	0.054059	3.209277	0.128053415

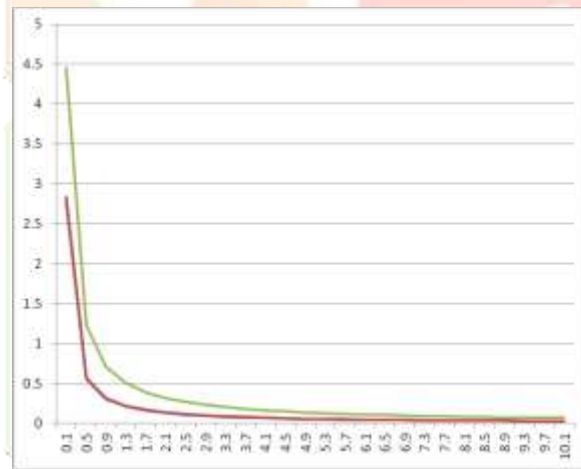

Fig 4.3 The Network lifetime as a function of mean number of packets transmitted. The red curve shows the Lifetime without data aggregation whereas the green curve shows the network lifetime with data Aggregation.

Thus, it is evident that the network lifetime increases with the data aggregation. Also, not much improvement on network life time can be achieved with clustering without data aggregation. This is because in the absence of data aggregation, the cluster head has to forward all the data packets it has received from the cluster members, thus causing battery depletion at a very fast rate. With the use of suitable data aggregation / data compression algorithm at the cluster head (full functional device FFD), a substantial improvement in the network lifetime can be achieved. The computation of latency that is introduced in the network as a result of clustering is not straightforward. In the case of clustering with no data aggregation, the latency involved is due to the fact that all the cluster nodes transmit the data to the cluster head and the cluster head transmits the data to the sink node. Latency is involved at A/D converter at CH, then the processing of the data. and again in D/A Ckt at the CH for transmission to the WSN Sink. In the case of clustering with data aggregation, latency is involved at A/D converter at CH, then the processing of the data as per some compression algorithm with certain time complexity, and again in D/A Ckt at the CH for transmission to the WSN Sink. Moreover, the computation of Latency is also affected by the type of the hardware (e.g, Bipolar RTL or CMOS) for the realization of wireless motes.

4.8 Analysis of NP- CSMA

Without carrier sensing, each node has the liberty to send data packets as per the requirement. It is assumed that the transmission of the data packets and the time critical GTS requests by the node follows Poisson Distribution. As depicted in Chapter 3, the probability of k frame transmissions per unit frame time is given by:

$$P_k = \frac{\lambda'^k * e^{-\lambda'}}{k!}$$

Here, $\lambda' = N(P_1 + P_2)$. Here, P_1 is the probability that the transmitted packet is a data packet and P_2 is the probability that the transmitted packet is a GTS request. Substitution of value of λ' in the above equation yields:

$$P_k = \frac{[N(P_1 + P_2)]^k * e^{-\lambda'}}{k!}$$

The plots for the above equation can be derived as shown in figure 4.1.

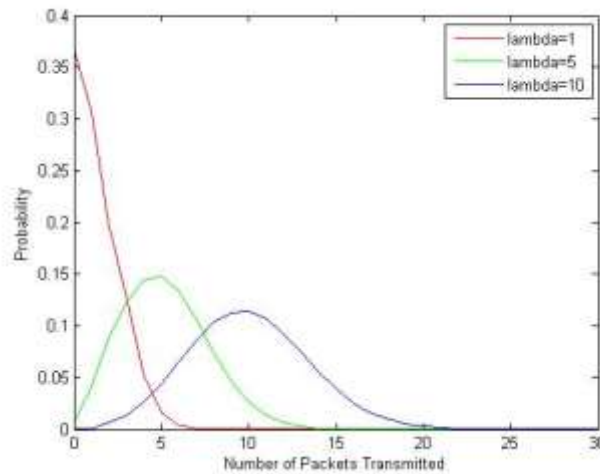

Fig 4.1 Poisson Probability Distribution for various mean values of Packet Transmission Rates -Continuous time

In fig 4,1 it is evident that the Poisson Probability Distribution takes the maximum value at the mean value. Thus, each of the curve finds its maximum at the mean value for which the Distribution is plotted.

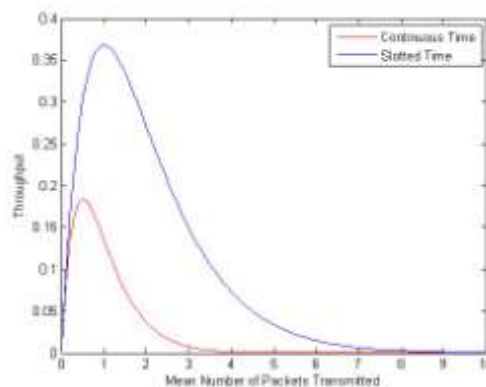

Fig 4.2 Throughput Analysis in pure and slotted time without carrier sensing

The plot in the figure 4.2 shows the case of ALOHA in continuous and in slotted time. In the absence of carrier sensing and any other policy for data transmission, each node is free to transmit the data packet as and when the need arises. The maximum throughput achieved in this case is 18 percent in case of continuous time. In the case of slotted time, the vulnerable period is reduced to half of its value, thus, the throughput achieves double the value as compared to that in the pure time. This value is 36 percent and still is very low. The plot in figure 4.3 shows the generic probability of packet transmission in Non Persistent CSMA. It is evident from the figure that the probability of packet transmission increase with the increase in the number of nodes in the network. Also, for any particular value of number of nodes in the network, the probability of packet transmission increases with the increase in the mean value of packet transmission (data packet traffic) in the network.

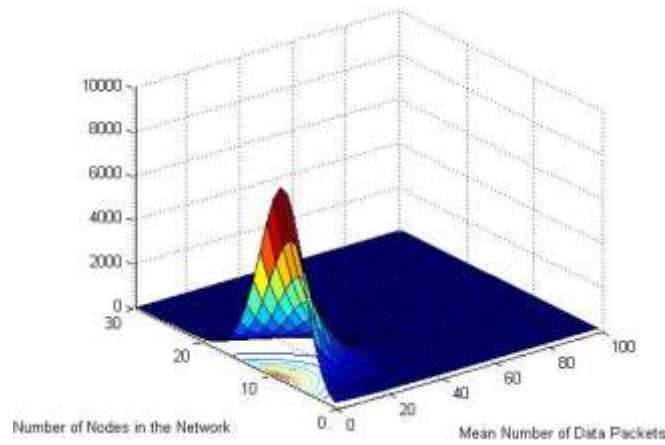

Fig 4.3 Analysis of NP CSMA - Generic Probability of Packet Transmission

Figure 4.4 shows the transition probability of transmission channel for getting into ideal state from any of the state viz, idle, successful transmission and collision. It is evident from the figure that the probability of getting into the idle state increases as the time duration of the slot decreases. Also, the probability of getting into the idle state decreases as the mean value of packet transmissions by the node increases. Both these results are consistent with the practical scenario of the state of the channel in IEEE 802.15.4 MAC.

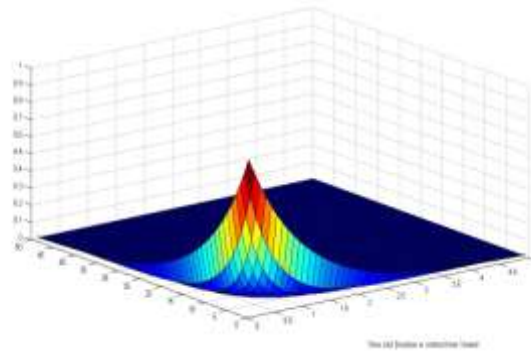

Fig 4.4 Analysis of NP CSMA - Probability of Getting into the ideal state: right horizontal axis shows the Time Slot Duration in slotted time Variant and left horizontal axis shows the Mean Number of Data Packets/GTS Requests Transmitted per unit time

Figure 4.5 shows the transition probability of the system for having successful transition state from any of the three state of the system, viz, being idle, being in collision state or being already successful transmission state. It is evident from the figure that there are various peaks for successful packet transmission as the max value depends upon the number of nodes in the network and the mean number of data packets transmitted by each node in the network.

The probability of successful packet transmission is given as per the equation given in chapter 3, namely;

$$P_{k=1} = aG * e^{-aG}$$

repeated here for ready reference. It is important to note that the packet transmission is successful if and only if a single node transmits the packet and all other nodes in the network are silent. Thus, corresponding to the values of slot duration and the mean number of data/GTS packets, there are several maxima for the probability of successful packet transmission.

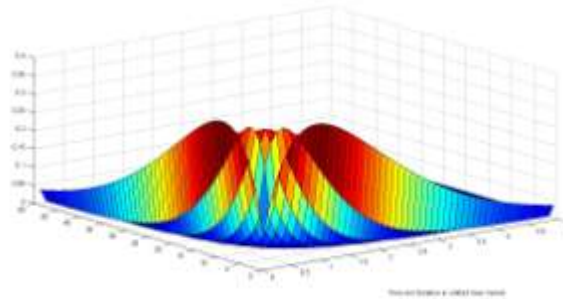

Fig 4.5 Analysis of NP CSMA - Probability of successful packet transmission: right horizontal axis shows the Time Slot Duration in slotted time Variant and left horizontal axis shows the Mean Number of Data Packets/GTS Requests Transmitted per unit time

Figure 4.6 shows the probability of the channel being in collision state from any of the state viz; idle, collision or successful packet transmission. It is evident from the figure that the probability of collision increases with the increase in the mean traffic rates of packet transmission by the nodes as well as the slot length in IEEE 802.15.4 MAC.

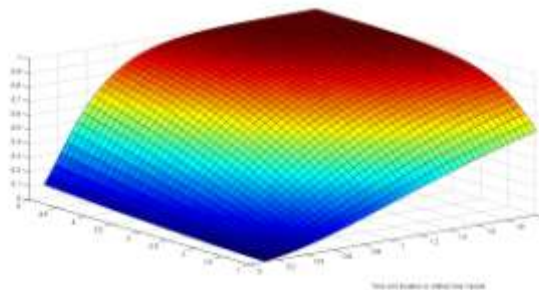

Fig 4.6 Analysis of NP CSMA - Probability of Packet Collision: right horizontal axis shows the Time Slot Duration in slotted time Variant and left horizontal axis shows the Mean Number of Data Packets/GTS Requests Transmitted per unit time

In the case of Non Persistent CSMA, it is important to note that the transmission channel can only be any one of the three states of the system, namely:

1. Idle Channel
2. Successful Transmission
3. Collision State

Figure 4.7 shows the steady state probability of being in idle state, in normalized condition, with respect to all the three state of the system. In the similar ways, figure 4.8 shows the stated state probability of the system being in collision state and figure 4.9 shows the probability of the system in successful transmission state.

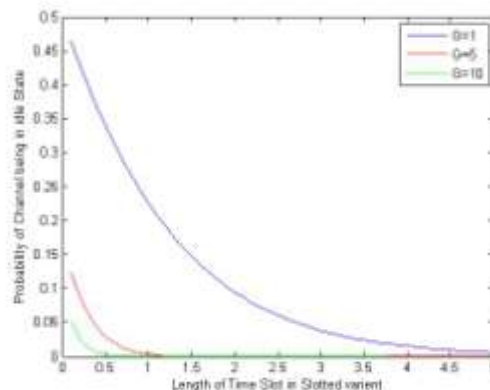

Fig 4.7 Analysis of NP CSMA - Steady State Probability of being in Idle State

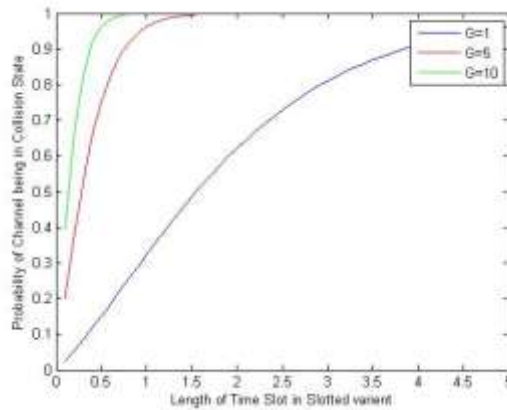

Fig 4.8 Analysis of NP CSMA - Steady State Probability of being in Collision State

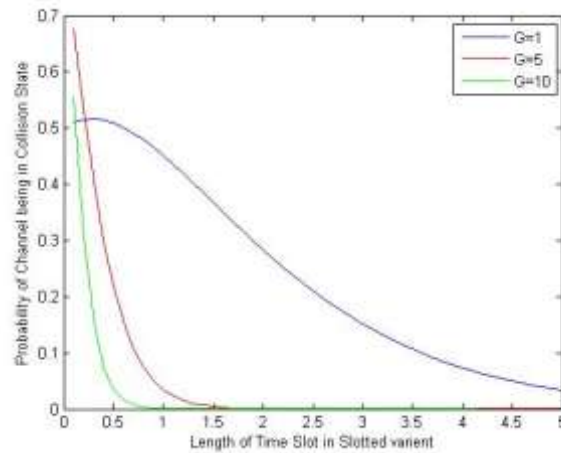

Fig 4.9 Analysis of NP CSMA - Steady State Probability of being in Successful Transmission State

4.9 Analysis of P Persistent- CSMA of IEEE 802.15.4 MAC Through SPN

The Petri Net Model of the state of transmission channel in IEEE 802.15.4 MAC is depicted in chapter 3. The same is repeated here for ready reference.

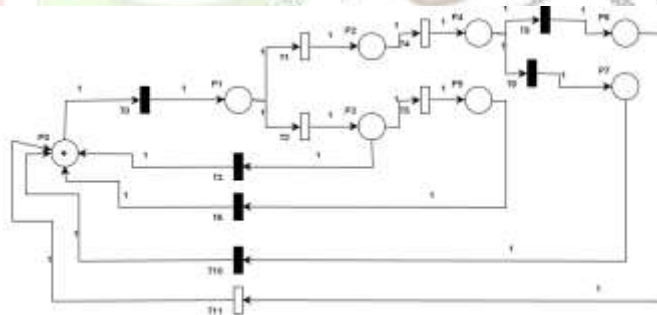

Fig 4.10 SPN model for state of the transmission channel

The set of tangible states of the channel state space derived by the Stochastic Petri Net analysis of the system are shown in table 4.1.

TABLE 4.1
SET OF TANGIBLE STATES OF THE SYSTEM

	P0	P1	P2	P3	P4	P5	P6	P7
M0	0	2	0	0	0	0	0	0
M1	0	1	1	0	0	0	0	0
M2	0	1	0	0	0	0	1	0
M3	0	0	2	0	0	0	0	0
M4	0	0	1	0	0	0	0	0
M5	0	0	0	0	0	0	2	0

A tangible state refers to the state of the system that can be achieved in the normal working operation of the system. In this case, the markings M0 to M5 denotes the tangible states of the system in which the tokens are at the places as depicted in the table 4.1

The normalized probability distribution of the tangible states of the system is given by table 4.2.

TABLE 4.2
PROBABILITY DISTRIBUTION OF TANGIBLE STATES OF THE SYSTEM

Marking	Value (Persistence of the system in the corresponding state)
M0	0.23529
M1	0.23529
M2	0.11765
M3	0.23529
M4	0.11765
M5	0.05882

It is easy to verify that the sum of all the values in the second column of table 4.2 is 1.

V CONCLUSION

The present work focuses on the Data Aggregation and latency tradeoff considering the first order radio energy dissipation model and provides analytical equation for the same. Based on this analysis, one can determine the optimal network configuration for particular deployment of the WSN.

This research follows a bottom up approach from data link layer performance modeling to clustering at application layer and data transmission using specified schedule by cluster head. However, as a future scope of the work, the specifics of the underlying hardware technology is to also to be take into account as the power dissipation varies greatly with the type of technology used for the realization of the sensor mote. However, the results presented in this analysis are of qualitative importance in every time of realization, as the ratio of energy expenditure in transmission and processing holds the same in almost all the IC technologies.

REFERENCES

- [1] T. de Almeida Oliveira and E. P. Godoy, "ZigBee Wireless Dynamic Sensor Networks: Feasibility Analysis and Implementation Guide," in *IEEE Sensors Journal*, vol. 16, no. 11, pp. 4614-4621, June 1, 2016.
doi: 10.1109/JSEN.2016.2542063
- [2] Y. Zhang; M. Qiu; C. W. Tsai; M. M. Hassan; A. Alamri, "Health-CPS: Healthcare Cyber-Physical System Assisted by Cloud and Big Data," in *IEEE Systems Journal*, vol. PP, no. 99, pp. 1-8
doi: 10.1109/JSYST.2015.2460747
- [3] V. Stangaciu, D. Pescaru, M. V. Micea and V. Cretu, "Practical aspects regarding implementation of real time WSN applications based on IEEE 802.15.4," *Telecommunications Forum (TELFOR), 2013 21st*, Belgrade, 2013, pp. 295-298.
doi: 10.1109/TELFOR.2013.6716229
- [4] M. Eskola, T. Heikkilä and P. Tukeva, "Deriving test procedures of Low-Rate Wireless Personal Area Networks," *Performance Evaluation of Computer and Telecommunication Systems (SPECTS), 2012 International Symposium on*, Genoa, 2012, pp. 1-8.
- [5] M. López *et al.*, "Software management of power consumption in WSN based on duty cycle algorithms," *EUROCON, 2013 IEEE*, Zagreb, 2013, pp. 399-406.
doi: 10.1109/EUROCON.2013.6625014
- [6] B. LaMeres *et al.*, "Position sensitive radiation detector integrated with an FPGA for radiation tolerant computing," *Sensors, 2010 IEEE*, Kona, HI, 2010, pp. 208-213.
doi: 10.1109/ICSENS.2010.5690418

- [7] N. Salman, I. Rasool and A. H. Kemp, "Overview of the IEEE 802.15.4 standards family for Low Rate Wireless Personal Area Networks," *Wireless Communication Systems (ISWCS), 2010 7th International Symposium on*, York, 2010, pp. 701-705. doi: 10.1109/ISWCS.2010.5624516
- [8] Jui-Hung Yeh, Jyh-Cheng Chen and Chi-Chen Lee, "WLAN standards," in *IEEE Potentials*, vol. 22, no. 4, pp. 16-22, Oct.-Nov. 2003. doi: 10.1109/MP.2003.1238688
- [9] G. Sarmiento, W. Grote and K. Al Agha, "Performance Analysis of Slotted CSMA/CA IEEE 802.15.4 with Heterogeneous No-Acknowledged Uplink Traffic," *2009 3rd International Conference on New Technologies, Mobility and Security*, Cairo, 2009, pp. 1-5. doi: 10.1109/NTMS.2009.5384754
- [10] Y. Huang *et al.*, "Cluster-Head and Border-Node Based Cluster Routing Protocol for LR-WPAN," *2016 IEEE 30th International Conference on Advanced Information Networking and Applications (AINA)*, Crans-Montana, 2016, pp. 132-139. doi: 10.1109/AINA.2016.31
- [11] K. A. Waghmare, P. N. Chatur and S. S. Mathurkar, "Efficient data aggregation methodology for Wireless Sensor Network," *2016 International Conference on Wireless Communications, Signal Processing and Networking (WiSPNET)*, Chennai, 2016, pp. 137-139. doi: 10.1109/WiSPNET.2016.7566107
- [12] S. Kumar, U. K. Verma and D. Sinha, "Performance analysis of LEACH and ENHANCED LEACH in WSN," *2016 International Conference on Circuit, Power and Computing Technologies (ICCPCT)*, Nagercoil, 2016, pp. 1-7. doi: 10.1109/ICCPCT.2016.7530340
- [13] N. Hayashi and S. Takai, "A GTS scheduling for consensus problems over IEEE 802.15.4 wireless networks," *Control Conference (ECC), 2013 European*, Zurich, 2013, pp. 1764-1769.

