

CFD ANALYSIS OF STEEL GRADE CHANGE IN A WATER MODEL TUNDISH

¹ Lohith Kumar P, ²Shobha B S

^{1,2} Lecturer, Department of Mechanical Engineering, DACG Government Polytechnic-577101, Karnataka

Email: plohith041@gmail.com, shobhaursbs@gmail.com

Abstract - The tundish working as a buffer and distributor of liquid steel between the ladle and continuous casting (CC) moulds. It plays a vital role in the performance of CC machine, Solidification of liquid steel and quality of productivity. Therefore it is necessary to control the flow pattern, heat transfer and inclusion particle movement of molten steel in the tundish[1]. Hence this paper targets to study the performance of tundish by studying water volume fractions and validated against the Planar Laser Induced Fluorescence (PLIF) results obtained from available literature. The variation of time dependent concentration field is measured by PLIF. Due to special calibration procedure of the PLIF system the optical, geometrical and physical parameters do not have to be determined analytically, thus leading to reliable results. The experiments have shown that the mixing process correlates with the quasi steady state flow pattern. Such information is important in steel production because the number of mixed slabs produced during sequence casting with a grade change is closely related to the mixing of the tundish melt. Hence in this paper PLIF measurements are used to validate numerical solutions of the mixing processes in water models of metallurgical reactor[2].

Keywords: Continuous Casting, Tundish, PLIF, water volume fraction

I. INTRODUCTION

India has emerged as the fourth largest steel producing nation in the world, as per the recent figures release by World Steel Association in April 2011. In 2010, India was the 5th largest producer, after China, Japan, USA and Russia had recorded a growth of 11.3% in steel production as compared to 2009[3]. Steel is more environmentally compatible because it is produced with a minimum energy input and can be recycled without loss of quality.

A continuous casting plant primarily consists of the ladle turret, several steel ladles, tundish, and oscillating mould with lower rolls to support the strand. The secondary metallurgy (degassing, de-oxidation, alloying, temperature and cleanliness adjustments) taking place in the ladle is a discontinuous process, whereas the solidification of the steel melt in the mould to a strand is a continuous process. The tundish links the discontinuous secondary metallurgy with the continuous casting. It serves as steel melt buffer during

the ladle change, distributes the steel melt to several strands and separates non-metallic particles (i. e. Al₂O₃, SiO₂) into the top slag cover due to buoyancy forces.

Due to high temperatures of the steel melt, the flow and thermal phenomena are in a range for which no adequate measurement technique is available. For this reason, physical and numerical simulations have to be done. Water can be used for the physical simulation because the kinematic viscosities of steel melt and water are comparable, thus making the fluidic behavior of both fluids similar ($\nu_{\text{steel}, 1536^\circ\text{C}} = 8.26 \cdot 10^{-7} \text{ m}^2/\text{s}$, $\nu_{\text{water}, 20^\circ\text{C}} = 10.0 \cdot 10^{-7} \text{ m}^2/\text{s}$). Considering the similarity laws, the results for water can be transferred to the steel melt. These results are used to provide quantitative information of the concentration fields in water models of metallurgical reactors and using the results as validation criteria for CFD simulations[2].

II. LITERATURE

The modeling and design of the tundish and tundish furniture can be divided into three main categories, i.e., physical modeling, plant trials and mathematical modeling. Physical modelling has great benefits over doing plant trials. Physical modelling has great benefits over doing plant trials[1].

- It does not operate under harsh conditions.
- It does not interfere with the plant production.
- It has got good control as it is carried out in Laboratory

PLIF is one technique among the physical modelling techniques. The principle of PLIF is that Some naturally occurring materials glow under the influence of energy. The emitted radiation in the visible range is called luminescence. It is to be distinguished between fluorescence and phosphorescence. Fluorescence arises spontaneously and stops as soon as the input of energy stops ($10^{-9} \text{ s} < t < 10^{-6} \text{ s}$), whereas phosphorescence lasts substantially longer after the input of energy ($10^{-4} \text{ s} < t < 10^2 \text{ s}$). In PLIF (Planar Laser Induced Fluorescence) technique, the physical quantity is measured inside a thin laser light sheet plane. The fluorescence signal is recorded by CCD (Charged Couple Device) cameras, which are equipped with monochromatic filters to separate the fluorescence signal from the excitation light. PLIF is a non-

intrusive in-situ-measurement technique with a high temporal and/or spatial resolution.

The PLIF measurements have been carried out at a water model (scale 1:3) of a 16 tonnes single-strand tundish with flat bottom. In steelworks, the tundish without any flow control devices is used to produce stainless steels (X5CrNi18-9, AISI 304). Figure 3 shows the test rig of the water model tundish with the DPIV/PLIF system, flexible laser light arm with the CCD-cameras and the piping of the test rig.

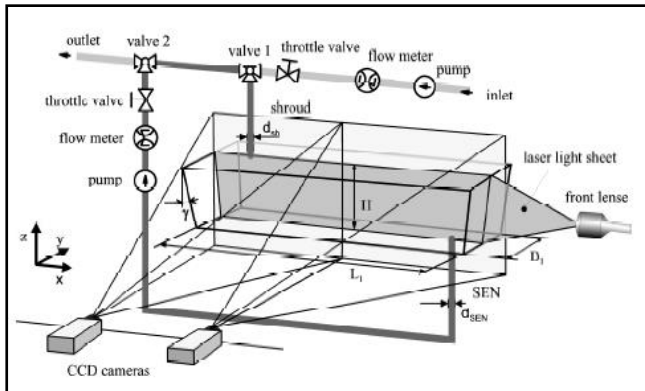

Fig. 1. CF Water model tundish (scale 1:3) and PLIF facilities and piping of the test rig

A certain amount of fluorescent dye is gradually added to a known volume of fresh water during the calibration process. Thus, the maximum, known concentration in the water model arises at the end of the calibration. This process is carried out for a thin object and laser light sheet plane, respectively so that optical, geometrical, and physical parameters have not to be determined. This way, one can forego the theoretical determination of the spatially varying intensity I_E inside the laser light sheet plane.

III. PRESENT WORK

From the literature survey it is found water volume fractions determined by PLIF technique can be used as the experimental results to validate numerical simulation done by using commercial package i.e ANSYS. Thus validated numerical model is used to simulate other tundish container designs to improve the molten steel flow pattern that leads in improving the performance of tundish and can produce high quality steel.

A. Objective

- Creating the baseline geometric model[1] of the tundish container using ANSYS design Modeller.
- Meshing[1] the geometric model of the tundish and checked for free of errors.
- To study the flow behaviour of the tundish container.
- To carry out numerical study of tundish container using ANSYS simulator and validating the numerical results to a water model by comparing with water volume fractions

B. Methodology

- Pre Processing: Consists of the construction of geometry, the generation of the mesh on the surfaces or volumes. This stage is done with the software ANSYS Meshing, linked to FLUENT. The geometry is created in ANSYS Design Modeller
- Definition of boundary conditions and other parameters, initial conditions, before starting a simulation in FLUENT, the mesh has to be checked, scaled and modified if necessary. The physical models have to be tackled. This includes the choice of compressibility, viscosity, heat transfer considerations, laminar or turbulent flow, steady or time dependent flow. The boundary conditions have to be clear because they specify the information of the state of the flow in the determined zones: walls, symmetries, inlet air, outlet air, etc
- Resolution of the problem, which is done through iteration until the convergence of the variables is obtained. First of all, the variables of the flow have to be initialized and set to be computed from a certain part specified by the user. In this stage the equations of the flow are solved. The values of the pressures are constantly updated and corrected through iterations. The convergence is checked until it reaches the criterion value set by the user.
- Post Processing or analysis of the results computed. There are lots of choices: water volume fractions are extracted.

IV. GEOMETRIC MODELLING , MESHING AND BOUNDARY CONDITIONS

A. Geometric Modelling

TABLE I. DIMENSIONS OF THE ORIGINAL 16 TONNES TUNDISH AND THE WATER MODEL TUNDISH (SCALE 1:3) ROGER KOITZSCH ET. AL [2]

Property	Symbol	Original Tundish	Model Tundish
Volume of tundish at filling level	V in m ³	2.227	0.084
H			
Tundish length	L ₁ in m	3.140	1.047
Tundish Width	B ₁ in m	0.780	0.260
Inclination of side walls	γ in °	7.000	7.000
Filling level of steady state casting	H in m	0.800	0.266
Distance shroud-bottom of tundish	Z _{sh} in m	0.600	0.200
Position of Shroud	L _{sh} in m	0.335	0.122
Diameter of Shroud	d _{sh} in m	0.068	0.023
Position of SEN	L _{SEN} in m	2.885	0.962
Diameter of the SEN	d _{SEN} in m	0.070	0.023
Cross section of the tundish	A in m ²	0.703	0.079
Hydraulic Diameter	d _{hyd} in m	1.175	0.691

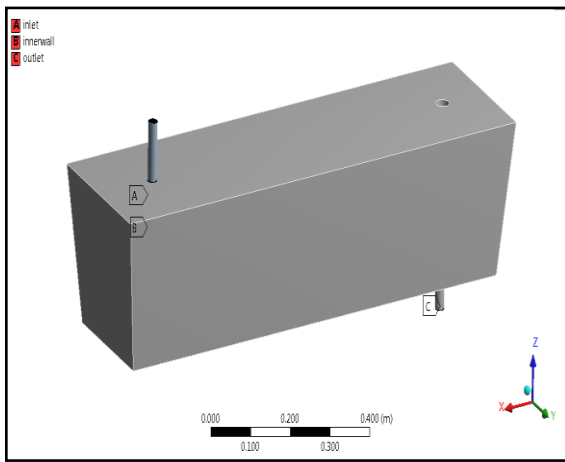

Fig. 2. 3D modeling of tundish container.

B. Meshing

The three-dimensional model is then discretized in ANSYS meshing element type is tetrahedral. Total no of elements used in this simulation is 0.55 millions as shown in Fig.3.

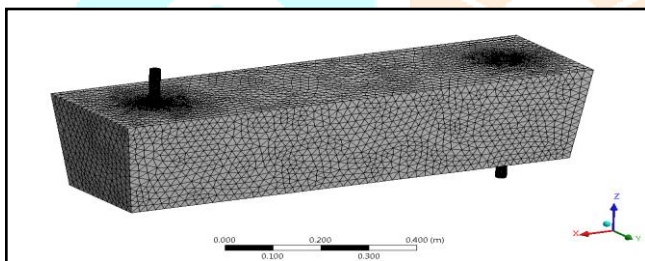

Fig. 3. CFD meshing details of tundish container without swirl chamber and dams.

C. Boundary Conditions

TABLE II. BOUNDARY CONDITIONS FOR A TYPICAL STEADY-STATE CASTING SEQUENCE OF THE 16 TONNES TUNDISH AND THE WATER MODEL TUNDISH ROGER KOITZSCH.ET.AL [2].

Parameters	Symbol	TUNDISH		
		Original	Water model	
			Re similarity	Fr similarity
Density	ρ in kg/m^3	7038	998	
Kinematic viscosity	ν in m^2/s	8.72×10^{-7}	10.06×10^{-7}	
Volumetric flow rate	\dot{V} in l/s	5.39	2.08	0.35
Mean velocity through the tundish	\bar{u} in m/s	0.0077	0.0267	0.0052
Velocity in the shroud	$ W_{sh} $	1.49	2.42	0.973
Mean residence time	t in s	420	84	210
Reynolds number	Re	10380	10.38	2110
Froude number	Fr	2.26×10^{-3}	1.36×10^{-3}	2.26×10^{-3}

V. RESULTS AND DISCUSSION

A tundish container has been simulated using commercial CFD software package FLUENT. The simulation has been done for 1:3 scaled water model tundish. The result i.e water volume fraction obtained is validated using available literature.

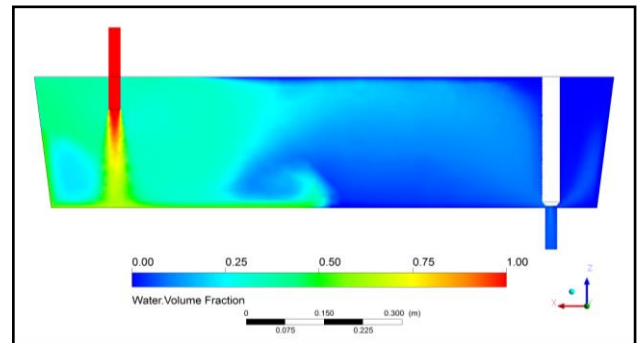

Fig. 4. Water volume fraction contour at mid plane after 30 sec.

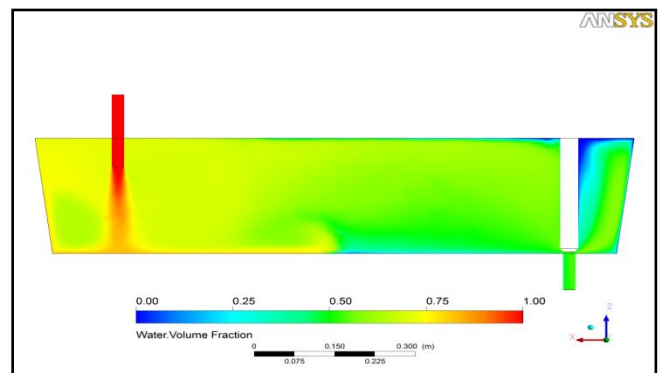

Fig. 5. Water volume fraction contour at mid plane after 85 sec.

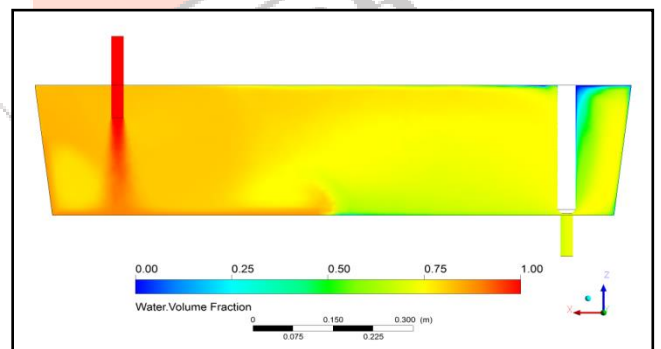

Fig. 6. Water volume fraction contour at mid plane after 125 sec.

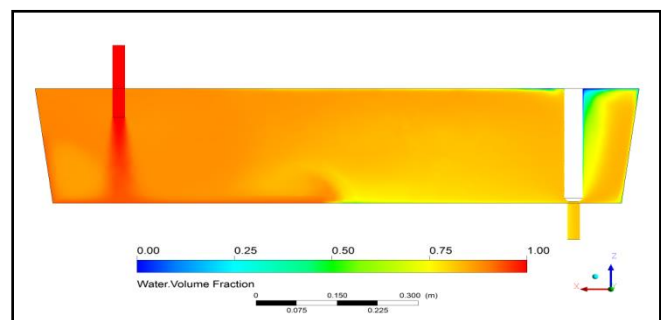

Fig. 7. Water volume fraction contour at mid plane after 160 sec.

Fig 4-7 exemplary shows the results of numerical simulation at different times. The high flow velocities in the inlet region of the tundish cause an intensive mixing. The turbulent character of the shroud jet which impacts on the bottom and is redirected to the side walls of the tundish can be clearly seen. The time-dependent and spatial expansion of the fresh water correlates with the convective mass and momentum transport, characterized by the quasi steady-state flow structure. The fresh water flows along the bottom of the tundish toward the SEN up to $x/L_1 = 0.5 - 0.6$. This bottom-based flow transports fresh water into the recirculating region. Because the mass and momentum exchange between the recirculating region and the ambience takes place very slowly, the concentration inside the recirculating region remains low for a while, Figure 5. For $\theta = 1.5$, Figure 6, the tundish can be roughly separated into three zones. A low concentration of $cr_h \approx 15\%$ is to be found in the inlet region of the tundish ($0 \leq x/L_1 < 0.33$). In the middle region ($0.33 \leq x/L_1 < 0.66$) the concentration of $cr_h \approx 25\%$ is quite high as well. In the outlet region ($0.66 \leq x/L_1 < 1$), and in particular below the free surface, clearly lower concentrations of $cr_h \approx 50\%$ can be found. From the outlet region of the tundish, water is transported inside the counter-rotating vortices back toward the inlet zone. Even for $\theta > 2$, Figure 7, the concentration below the free surface remains noticeably high.

VI. CONCLUSION

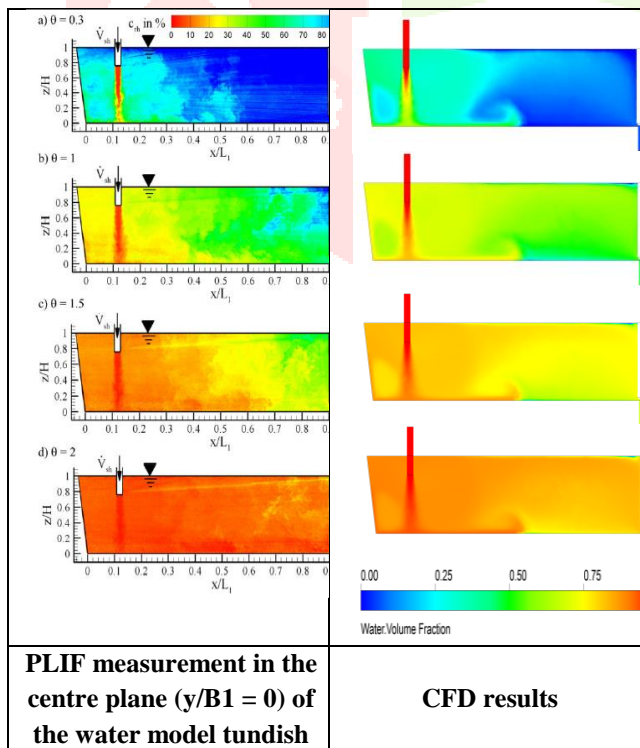

Fig. 8. Comparison of Water volume fraction contour at mid plane after

The continuous casting process is not a very old manufacturing process, but in the last four decades, it became the most common process for producing most basic metals. One of the particular important components in this system is the tundish. Traditionally, the tundish acted as a reservoir between the ladle and the mould but more recently it has been used a grade separator, an inclusion removal device and a metallurgical reactor. A continuous drive to understand the molten metal flow patterns inside the tundish has led to many research papers being published in the modeling of the flow patterns, through either water modeling or numerical modeling.

These numerical modeling involves number of steps. The first step is the validation the numerical (CFD) model. By comparing the water volume fraction contours we conclude that the model is in agreement with water model results obtained by PLIF experiment set up. In further step we can modify the geometrical changes like adding swirl chamber, dimensions. This validated model is applied to evaluate results. Hence numerical simulation helps in changing the design parameters and test the performance virtually. Through this we can optimize the tundish design parameters.

ACKNOWLEDGEMENT

I am very much thankful to my guide **Kisore N**, Assistant Professor, Department of Mechanical Engineering, Don Bosco Institute of Technology, Bangalore who has been a constant source of encouragement ever since the start of the of the work, helped me in all aspects and boosting my morale on several occasions. I acknowledge with deep gratitude for his total support in my work.

REFERENCES

- [1] Dr.D K Ramesha, Kishore , Sangamesh.M.Hosur "Numerical Study of Performance of Tundish Container using CFD" National Conference on Emerging Trends in Engineering and Management ISBN: 978-81-926416-0-7
- [2] Roger Koitzsch, Dr.-Ing. Hans-Jurgen Odenthal, Dr.-Ing. Herbert Pfeifer "Simulation of steel grade change in a water model tundish using the combined DPIV/PLIF Technique" Metal(2007)
- [3] <http://www.indiasteelexpo.in/IndustryOverview.php>
- [4] Chakraborty S, Sahai Y, "Mathematical Modelling of Transport Phenomena in Continuous Casting Tundishes' Iron& Steelmaking", Vol. 19, (6),(1992) pp. 479.
- [5] Kemeny F, Harris DJ, McLean A, Meadowcroft TR, Young JD, 'Fluid Flow Studies in the Tundish of a Slab Caster', Proceedings of the 2nd Process Technology Conf., Warrendale, PA, 1981.

- [6] Lievenspiel O, Chemical Reaction Engineering – An Introduction to the Design of Chemical Reactors, John Wiley and Sons Inc., New York, 1967.
- [7] Mazumdar D, Guthrie RIL, ‘The Physical and Mathematical Modelling of Continuous Casting Tundish Systems’, Iron and Steel Institute of Japan Int. Vol. 39, No. 6,(1999), pp.524-547
- [8] Singh S, Koria SC, “Model Study of the Dynamics of Flow of Steel Melt in the Tundish”, Iron and Steel Institute of Japan Int., Vol. 33, No. 12,(1993) pp. 1228-1237.

