

# SPWM TECHNIQUES IN FIVE LEVEL INVERTER

M.V.Subramanyam<sup>1</sup>, P.Kishor<sup>2</sup>, M.Srinivas<sup>3</sup>

<sup>1,2,3</sup>Assistant Professor, Department of EEE, Matrusri Engineering College, Hyderabad

**Abstract:** The five level inverter is most widely used inverter in medium and high voltage applications, since it has many advantages and easy to develop when compared to higher level(7 or 9) inverters. There are several modulation techniques and most popular among them is Sinusoidal Pulse Width Modulation(SPWM). There are different Sinusoidal Pulse width Modulation techniques such as In Phase Disposition(IPD), Anti Phase Disposition(APD), Phase Opposition Disposition(POD), Phase shift(PS), Anti-Phase Shift(APS), Variable Frequency(VF), Anti-Variable Frequency(AVF) and Carrier Overlap(CO)The THD of different Sinusoidal Pulse width Modulation techniques are found as carrier frequency is varied and compared .

**Keywords:** five level inverter, modulation technique, pulse width modulation, phase disposition, phase shift, variable frequency.

## I. INTRODUCTION

Multilevel Inverters have many advantages compared with and well known two level converters [1]. These advantages are fundamentally focused on improvements on the output quality and a nominal power increase in the inverter. The five level inverter is most widely used inverter in medium and high voltage applications, since it has many advantages and less complex architecture compared to higher level (7 or 9) inverters. There are several modulation techniques that can be used with 5 level inverters such as i) Sinusoidal Pulse Width Modulation (SPWM) technique ii) Selective Harmonic Elimination(SHE) and iii) Space Vector Modulation (SVM) technique. [2].There are again different methodologies in SPWM technique such as 1)In Phase Disposition PWM (IPDPWM) 2)Phase Opposition Disposition PWM (PODPWM) 3)Alternative Phase Opposition & Disposition PWM(APODPWM) 4) Phase Shift PWM(PSPWM) 5) Alternate Phase Shift PWM(APSPWM) 6)Carrier Overlap PWM(COPWM) 7)Variable Frequency PWM (VFPWM) 8)Alternate Variable Frequency PWM(AVFPWM) 9)Alternate Phase Disposition & Alternate Phase Shift PWM(APDAPSPWM)[2].

## II. MULTI LEVEL INVERTERS

Traditional two level and three level high frequency Pulse width modulated (PWM) inverters for motor drives has several problems associated with high frequency switching which produce common mode voltages and high rate of voltage change (dv/dt) to motor windings. The concept of using multiple small voltages to perform power conversion was introduced. These converters recently have found many applications in medium and high power applications. Recent advances in Power electronics made the multilevel concept practical. Based on the output voltage levels, inverters can be classified as two level inverters and Multi-level inverters. The inverters with voltage level 3 or more are referred as Multi-level inverters.[3]

The fundamental multilevel inverter topologies are diode clamped, flying capacitor and multilevel H-bridge. Diode clamped Multilevel Inverter is a very general and widely used topology for real power flow control. Normally n-level diode clamped Multilevel Inverter has  $2(n-1)$  main switches and  $2(n-1)$  main diodes. In addition, this topology needs  $2(n-2)$  clamping diodes [4]. So in the five level diode clamped inverter 8 main switches, 8 main diodes (D1 to D8) and 6 clamped diodes (DB1 to DB6) are used.[5] Fig.1 illustrates five level diode clamped multilevel inverter.

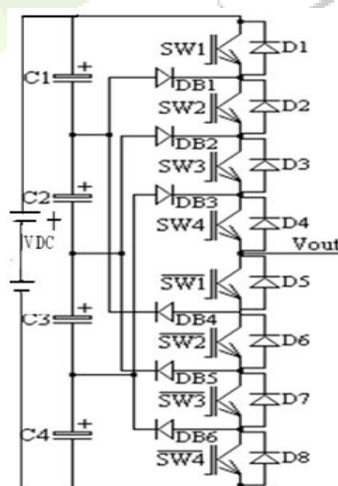

Fig. 1 One leg of Five Level diode clamped Multi-level inverter

## III. SPWM MODULATION TECHNIQUES

**In Phase Disposition PWM (IPDPWM):** In this method all four carrier waves are in phase .The converter is switched to  $+V_{dc}/2$  when the sine wave is greater than both upper carrier waves. The converter is switched to  $+V_{dc}/4$  when the sine wave is greater than first upper carrier waves. The converter is switched to zero when sine waveform is lower than upper carrier waveforms and higher than lower carrier waveforms. The converter is switched to  $-V_{dc}/4$  when sine wave is less than first lower carrier waveform. The converter is switched to  $-V_{dc}/2$  when sine wave less than both lower carrier waveforms. This method is shown Fig. 2

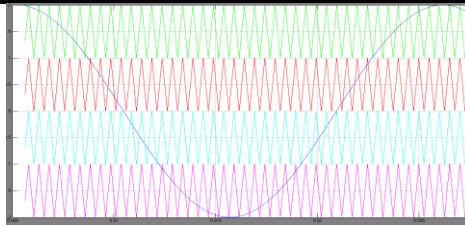

Fig. 2 In Phase Disposition Pulse Width Modulation (IPDPWM)

**Phase Opposition Disposition PWM (PODPWM):** In this method, four carrier waveforms are arranged so that all carrier Waveforms above zero are in phase and they are  $180^\circ$  out of phase with those below zero. This is shown in Fig. 3

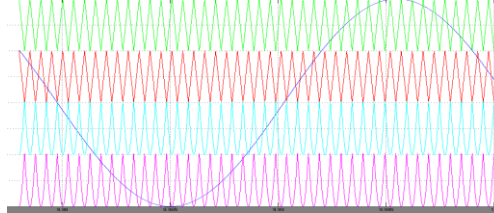

Fig.3 Carrier arrangement for Phase opposition disposition PWM (PODPWM)

**Alternate Phase Opposition & Disposition PWM (APODPWM) :** In this method, four carrier waveforms are arranged so that alternate carriers Waveforms are  $180^\circ$  out of phase with those other two alternate waveforms. This is shown in Fig. 4

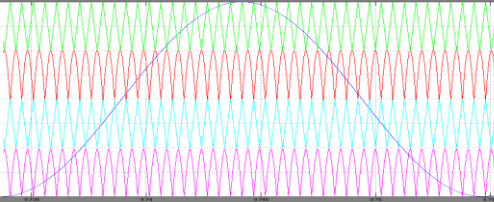

Fig.4 Carrier arrangement for Alternate Phase opposition disposition PWM (APODPWM)

**Phase Shift PWM (PSPWM):** In this method four carrier waveforms are arranged so that there is phase shift of  $90^\circ$  between each carrier waveforms. This is shown in Fig. 5

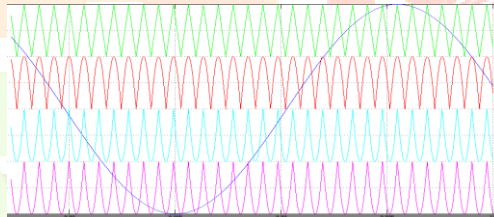

Fig. 5 Carrier arrangement for Phase Shift PWM (PSPWM)

**Alternate Phase Shift PWM (APSPWM):** In this method alternate carrier wave forms are shifted by  $90^\circ$ . This is shown in fig. 6

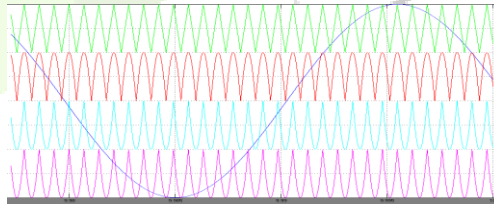

Fig. 6 Carrier arrangement for Alternate Phase Shift PWM (APSPWM)

**Carrier Overlap PWM (COPWM):** In this method four carrier waveforms overlap each other. This is shown in Fig. 7

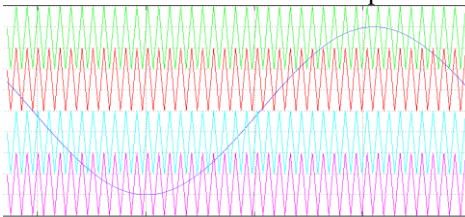

Fig. 7 Carrier arrangement for Carrier Overlap PWM (COPWM)

**Variable Frequency PWM (VFPWM):** In this method four carrier waveforms have different frequencies. This is shown in Fig. 8.

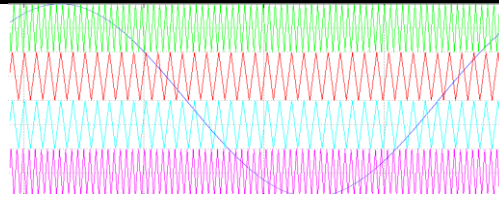

Fig. 8 Carrier arrangement for Variable Frequency PWM (VF PWM)

**Alternate Variable Frequency PWM(AVFPWM):** In this method alternate carrier waveforms frequencies are varied. This is shown in Fig. 9.

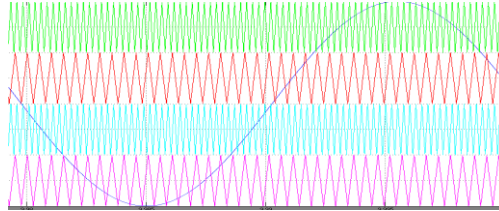

Fig. 9 Carrier arrangement for Alternate Variable Frequency PWM (AVFPWM)

**Alternate Phase Disposition & Alternate Phase Shift PWM(APDAPSPWM):** In this method , two alternate waveforms are 180° out of phase and remaining two alternate waveforms are 90° phase shift. This is shown in Fig. 10 .

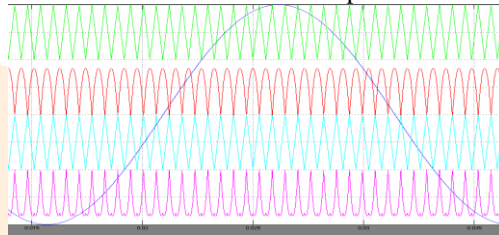

Fig. 10 Carrier arrangement for Alternate Phase Disposition & Alternate Phase Shift PWM(APDAPSPWM)

The above modulation techniques are having their own advantages and disadvantages several authors[ 6 - 8 ] compared their performances using simulation techniques.

**V. RESULTS**

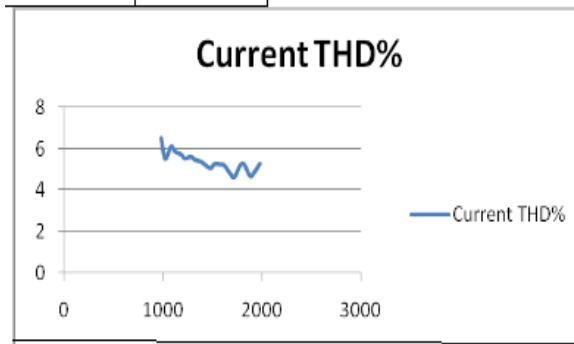

Fig. 11.In Phase Disposition PWM Stator Current THD

Fig. 11.Illustrates the variation of Stator Current THD with carrier frequency in- In Phase Disposition PWM .As the carrier frequency is varied from 980 Hz. to 1980 Hz. , the THD is varying between 4% and 7%.The minimum THD is 4.61 at 1720 Hz.

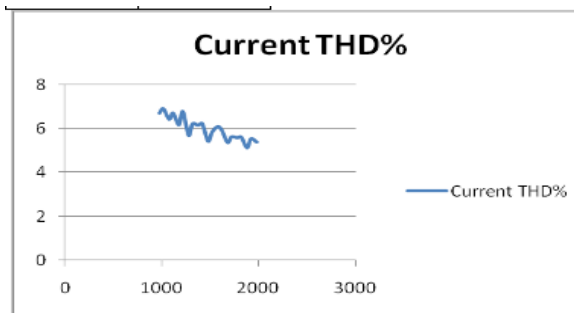

Fig. 12 Phase Opposition Disposition PWM Stator Current THD

Fig. 12.Illustrates the variation of Stator Current THD with carrier frequency in Phase Opposition Disposition PWM .As the carrier frequency is varied from 980 Hz. to 1980 Hz. , the THD is varying between 5% and 7%.The minimum THD is 5.13 at 1880 Hz.

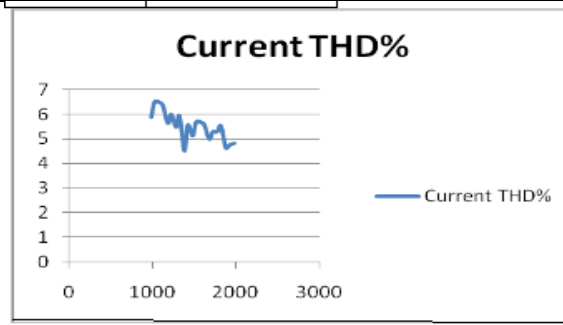

Fig. 13 Alternative Phase Opposition & Disposition PWM Stator Current THD

Fig. 13 .Illustrates the variation of Stator Current THD with carrier frequency in Alternative Phase Opposition & Disposition PWM .As the carrier frequency is varied from 980 Hz. to 1980 Hz. , the THD is varying between 4% and 7%.The minimum THD is 4.5 at 1380 Hz.

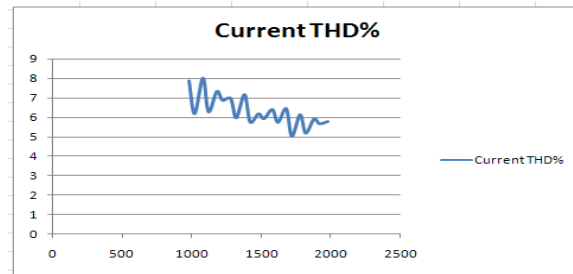

Fig. 14 Phase Shift PWM Stator Current THD

Fig. 14 .Illustrates the variation of Stator Current THD with carrier frequency in Phase Shift PWM .As the carrier frequency is varied from 980 Hz. to 1980 Hz. , the THD is varying between 5% and 8%.The minimum THD is 5.02 at 1720 Hz.

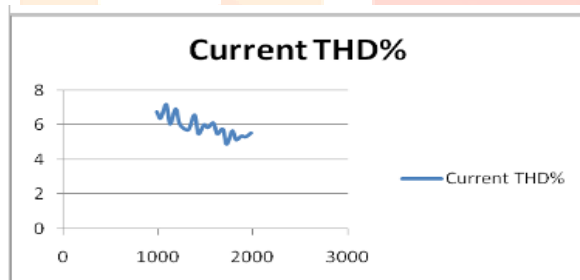

Fig. 15 Alternate Phase Shift PWM Stator Current THD

Fig. 15 .Illustrates the variation of Stator Current THD with carrier frequency in Alternate Phase Shift PWM .As the carrier frequency is varied from 980 Hz. to 1980 Hz. , the THD is varying between 4.5% and 7.5%.The minimum THD is 4.89 at 1720 Hz.

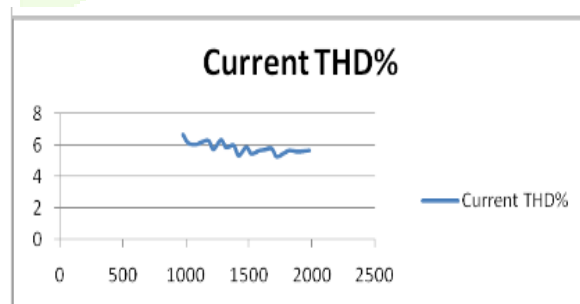

Fig. 16 Carrier Overlap PWM Stator Current THD

Fig. 16 .Illustrates the variation of Stator Current THD with carrier frequency in Carrier Overlap PWM .As the carrier frequency is varied from 980 Hz. to 1980 Hz. , the THD is varying between 5% and 7%.The minimum THD is 5.25 at 1720 Hz.

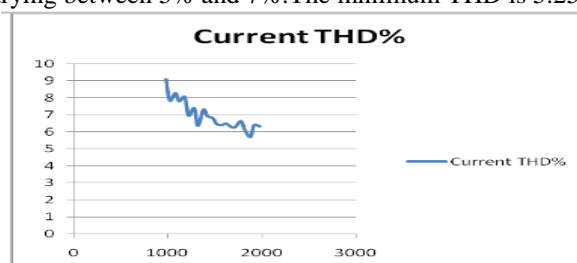

Fig. 17 Variable Frequency PWM Stator Current THD

Fig. 17 .Illustrates the variation of Stator Current THD with carrier frequency in Variable Frequency PWM .As the carrier frequency is varied from 980 Hz. to 1980 Hz. , the THD is varying between 5.5% and 9.5%.The minimum THD is 5.71 at 1880 Hz

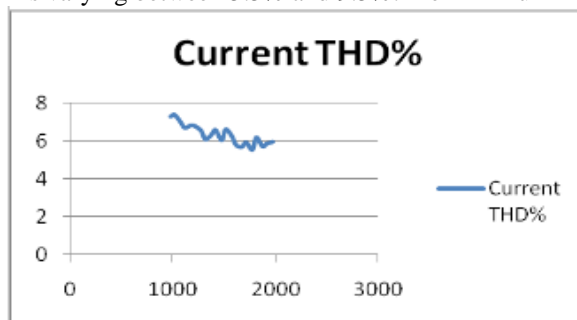

Fig. 18 Alternate Variable Frequency PWM Stator Current THD

Fig. 18 .Illustrates the variation of Stator Current THD with carrier frequency in Alternate Variable Frequency PWM .As the carrier frequency is varied from 980 Hz. to 1980 Hz. , the THD is varying between 5.5% and 7.5%.The minimum THD is 5.51 at 1780 Hz

## VI. CONCLUSION

It is clear from above results that the In Phase Disposition PWM , Alternative Phase Opposition & Disposition PWM and Alternate Phase Shift PWM techniques are best as the THD is below 5%. . As per IEEE standards the THD should be below 5%.

## REFERENCES

- [1] Jose Ignacio Leon Galvan "Multilevel converters: topologies, modeling, SVM techniques and optimization"; Doctoral thesis, University of Seville
- [2] M.V.Subramanyam, P.V.N.Prasad "SPWM Techniques in closed loop control of five level inverter fed 3 $\Phi$  Induction motor" , The IUP Journal of Electrical and Electronics Engineering, Vol VII, no. 4,2014,pp 43-53
- [3] R.Teodorescu, F.Beaabjerg, J.K.Pedersen, E.Cengeki, S.Sulistijo,Woo and P.Enjeti "Multi-Level Converters ; A Survey" in Proc. European power electronics conference, Switzerland 1999
- [4] Ying Cheng, Mariesa L Crow "A Diode Clamped Multi-level Inverter for the Statcom/BESS"; University of Missouri, USA
- [5] M.V.Subramanyam,S.Mani Kuchibhotla. P.V.N. Prasad-"Effect of carrier frequency on THD in closed loop control of 5- level Multi-Level Inverter fed 3 phase induction motor"- International Journal of Scientific & Engineering Research. Volume 4. Issue 5, May -2013. pp 804—809.
- [6] Reddy V Naga Bhaskar, Babu Ch. Sai and Suresh K, "Advanced Modulation Techniques for Diode Clamped Multi Level Inverter Fed Induction Motor" ARPJ Journal of Engineering and Applied Sciences. Vol. 6, No. 1,ISSN 1819 – 6608, 2011.
- [7] Farid Berrezzek and Farid Berrezzek "A Study of New Techniques of Controlled PWM Inverters ", European Journal of Scientific Research, Vol. 32, No. 1,pp 77-87,ISSN 1450-218X, 2009.
- [8] Balamurgan C R, Natrajan S P, and Bensraj R "Investigations on Three Phase Five Level Diode Clamped Multi Level Inverter" , International Journal of Modern Engineering Research(IJMER), Vol. 2, No. 3, pp 1273 – 1279,ISSN 2249 6645, 2012.